



SIGHT WORDS Activity Workbook



All About Me



Age:

Birthday:

Name:

Fun Facts About me



My Favorite ...

Food:

Color:

Pet:

Movie:

Sports:

Subject:

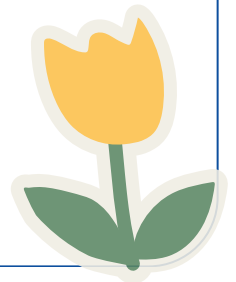

When I grow up I want to be ...

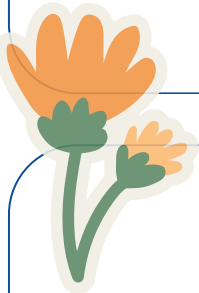

Name: _____

Date: _____

Trace the Letter

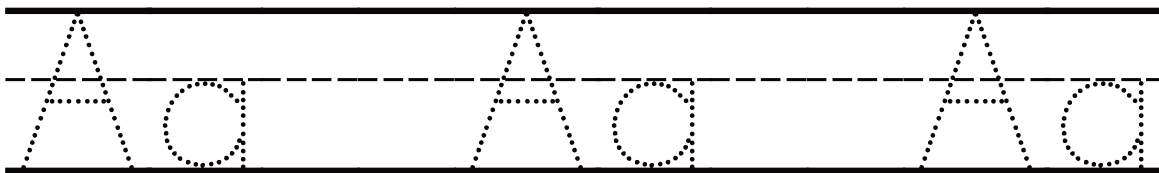
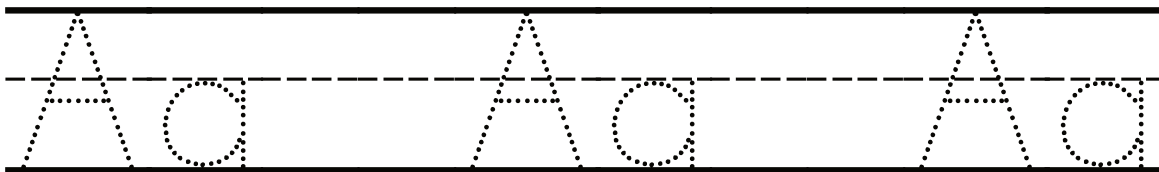
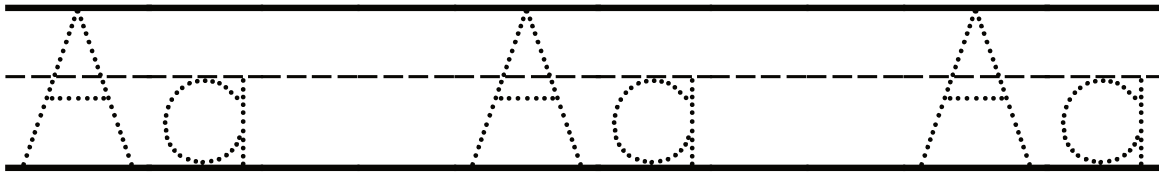
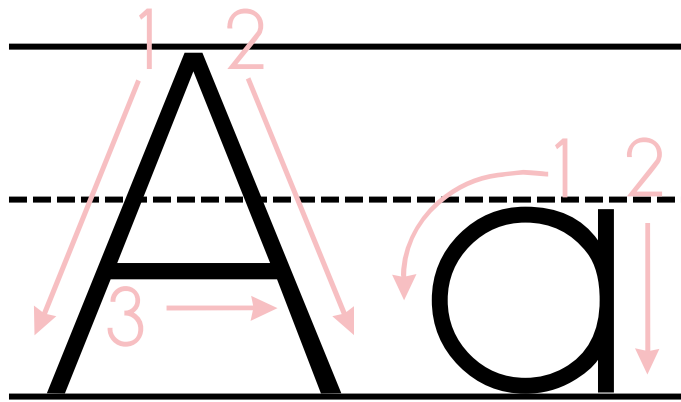

Name: _____

Date: _____

Trace the Letter

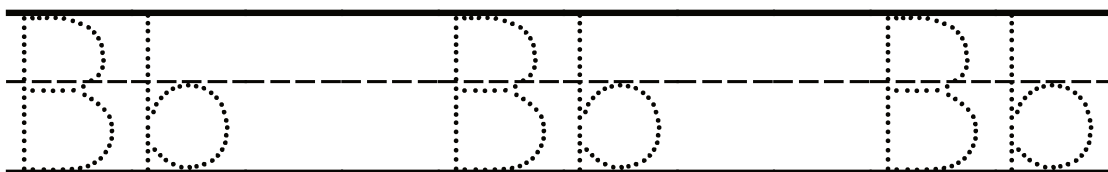
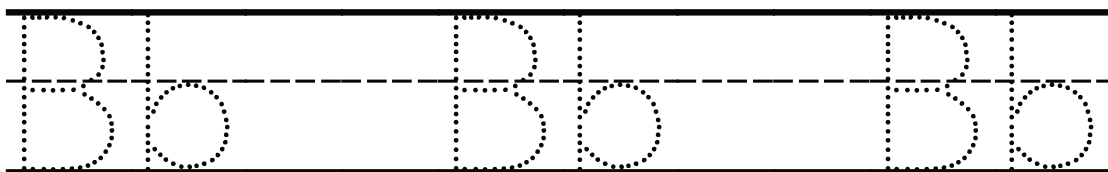
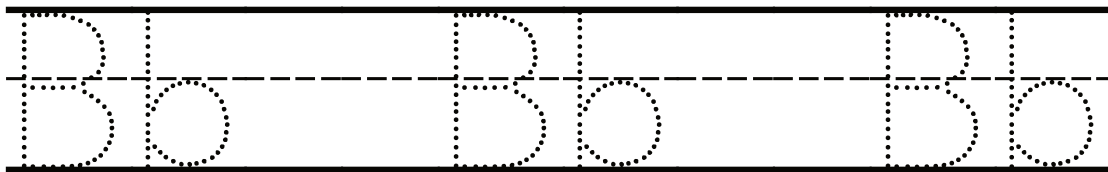
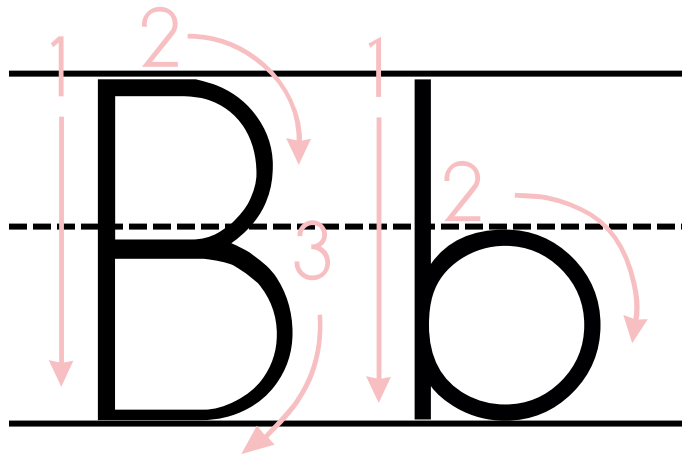

Name: _____

Date: _____

Trace the Letter

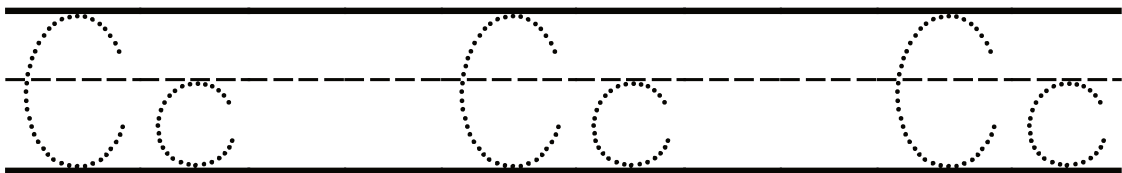
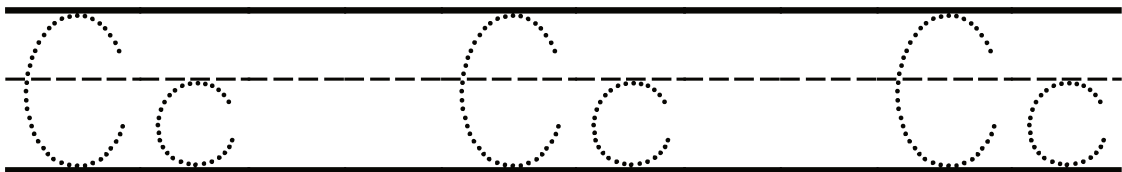
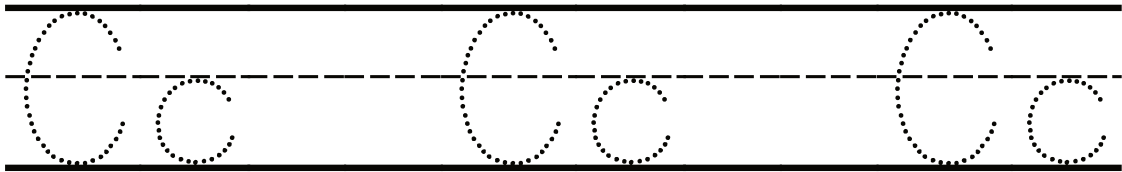
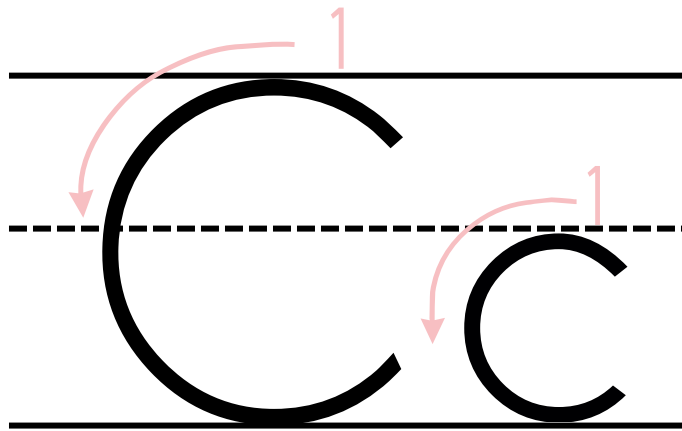

Name: _____

Date: _____

Trace the Letter

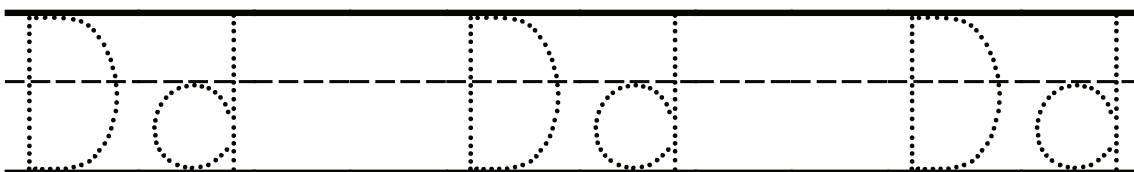
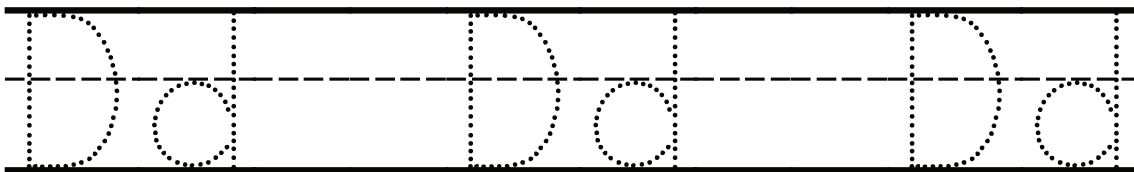
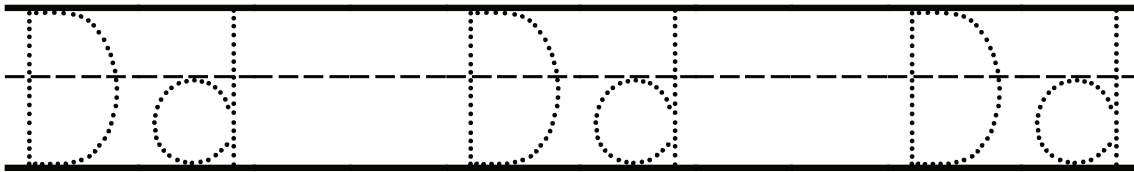
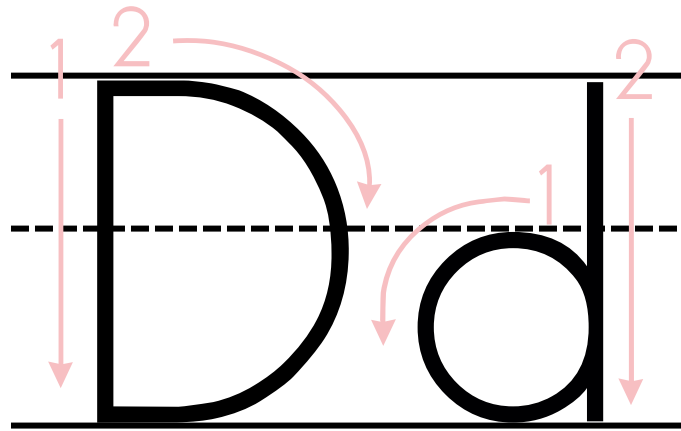

Name: _____

Date: _____

Trace the Letter

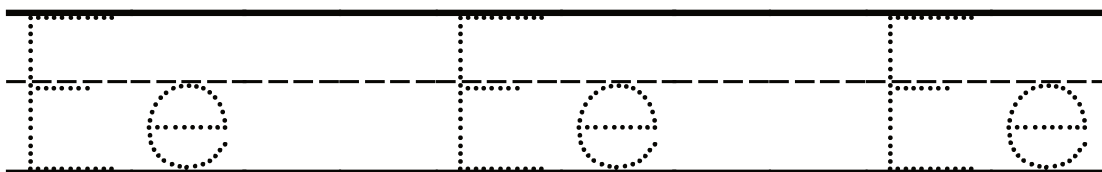
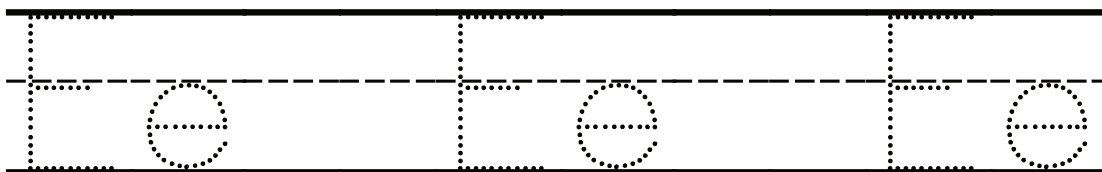
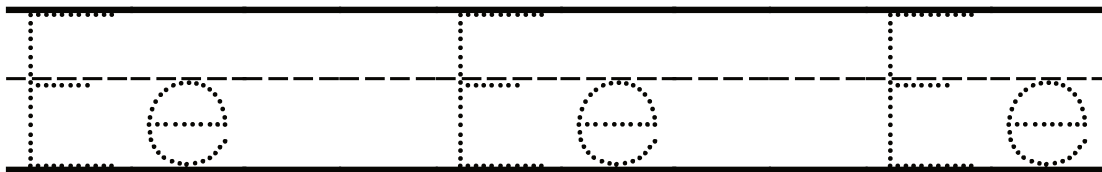
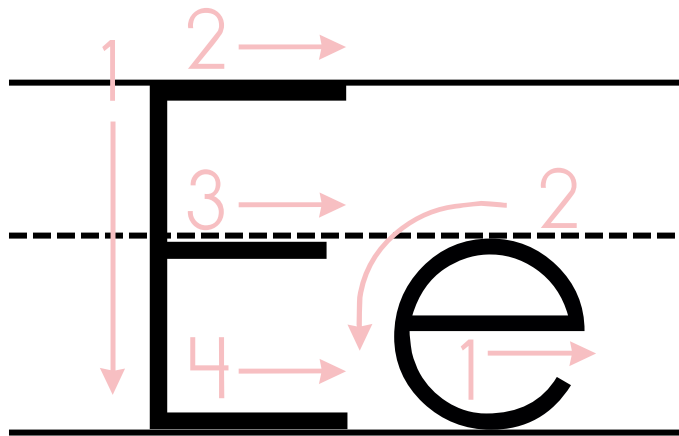

Name: _____

Date: _____

Trace the Letter

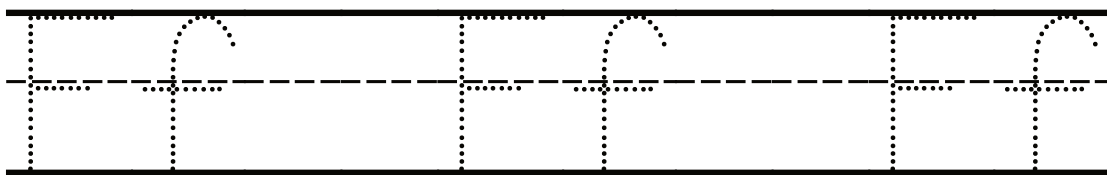
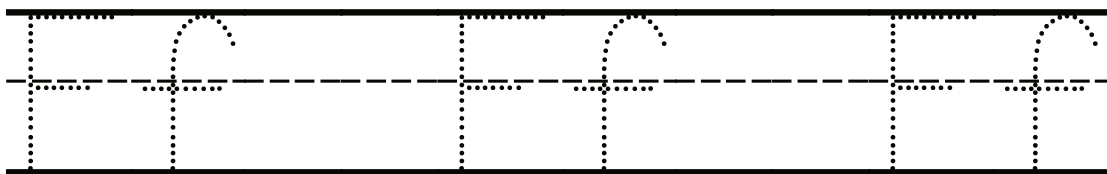
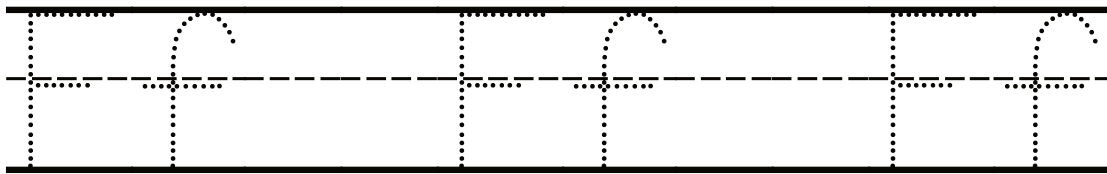
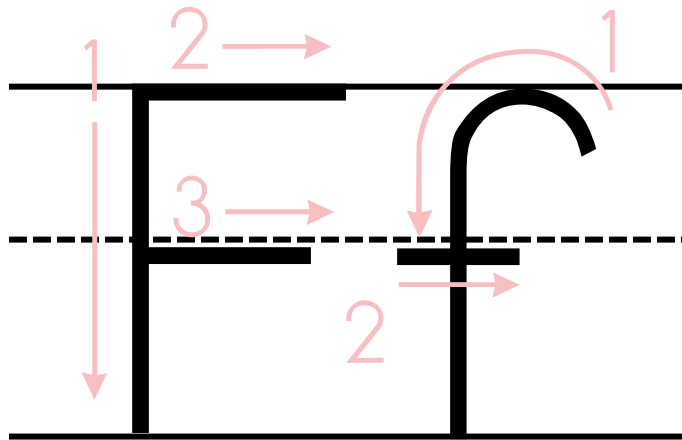

Name: _____

Date: _____

Trace the Letter

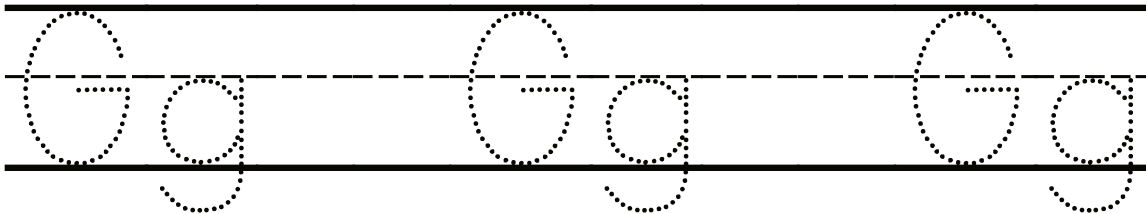
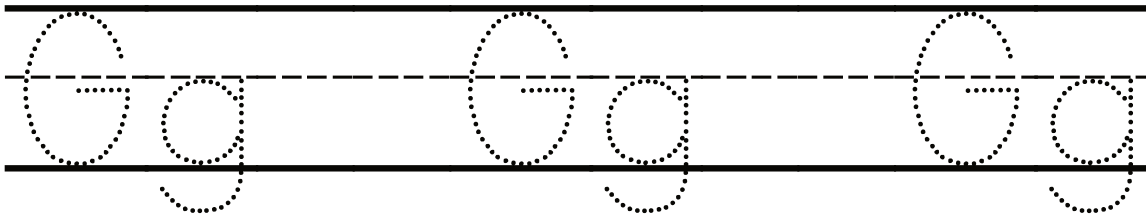
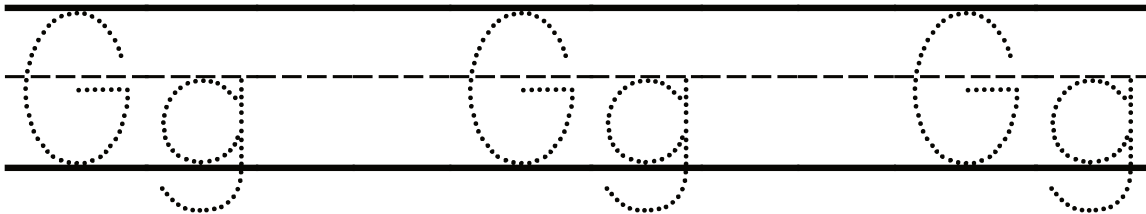
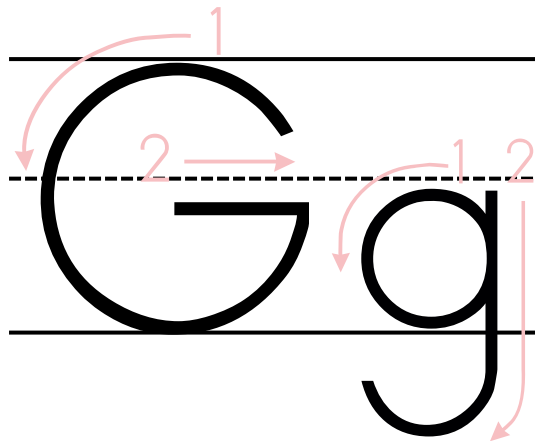

Name: _____

Date: _____

Trace the Letter

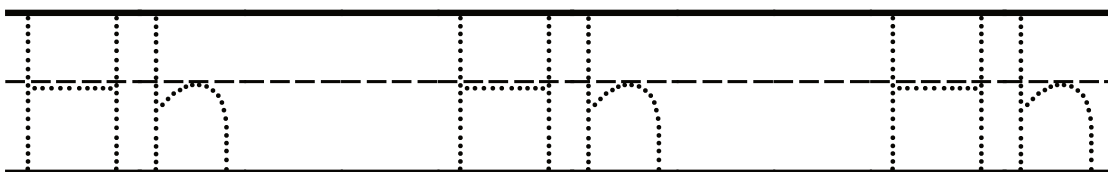
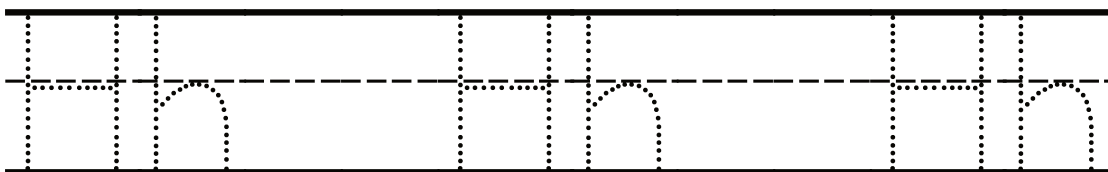
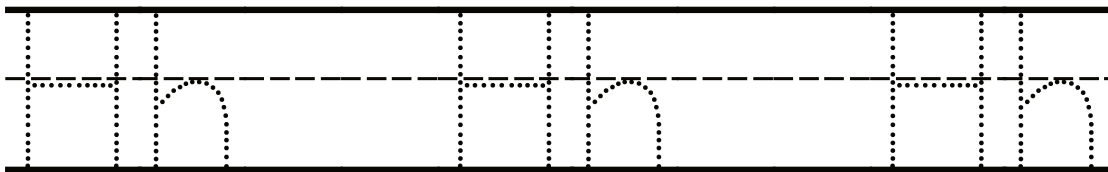
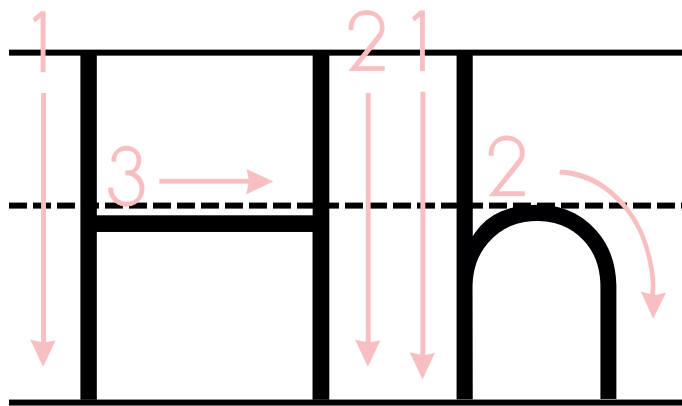

Name: _____

Date: _____

Trace the Letter

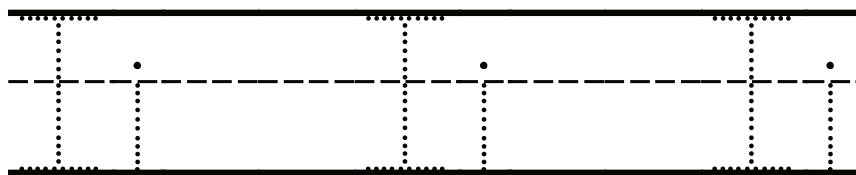
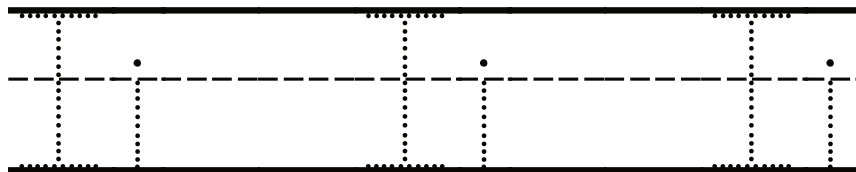
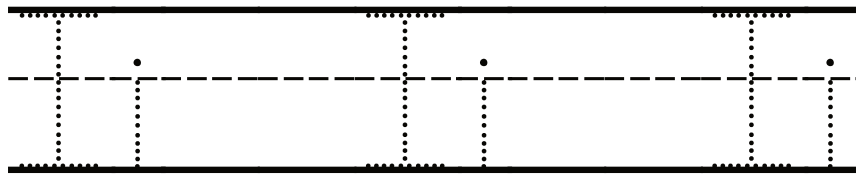
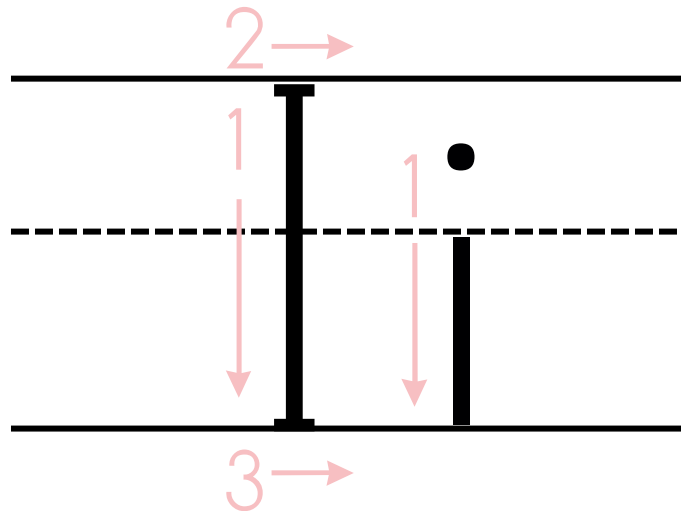

Name: _____

Date: _____

Trace the Letter

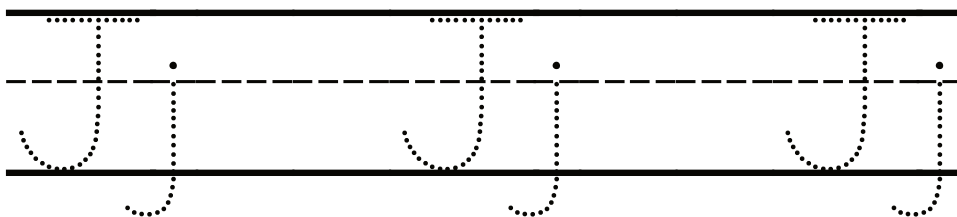
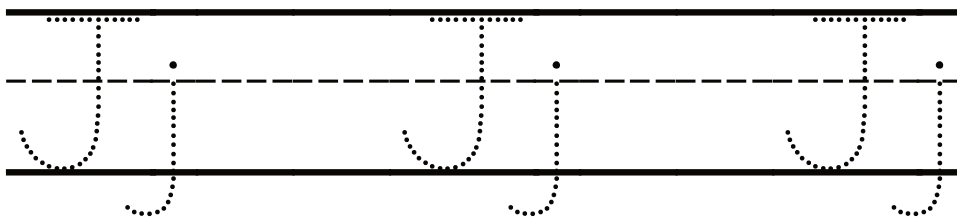
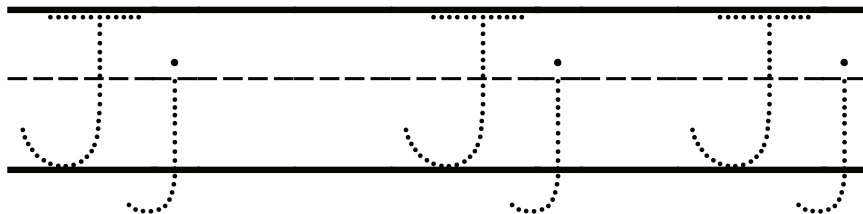
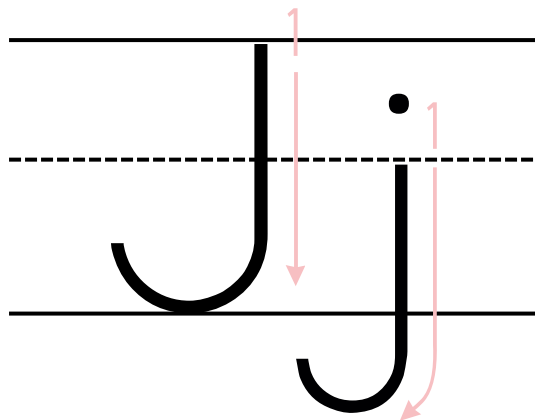

Name: _____

Date: _____

Trace the Letter

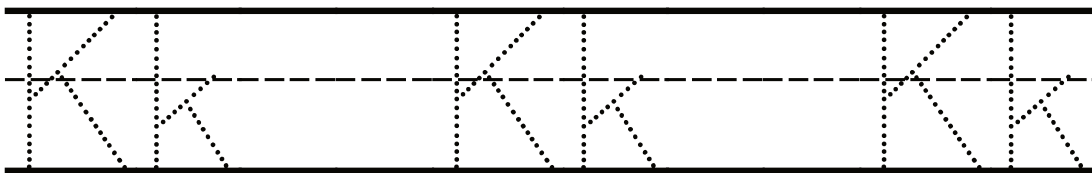
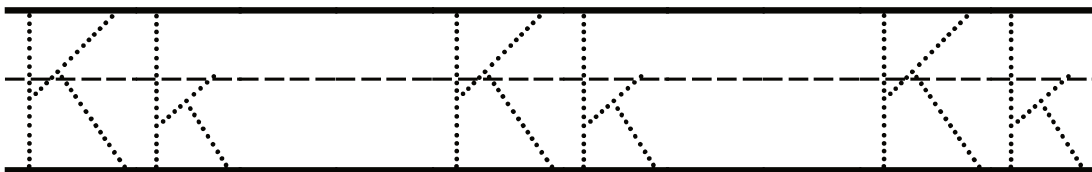
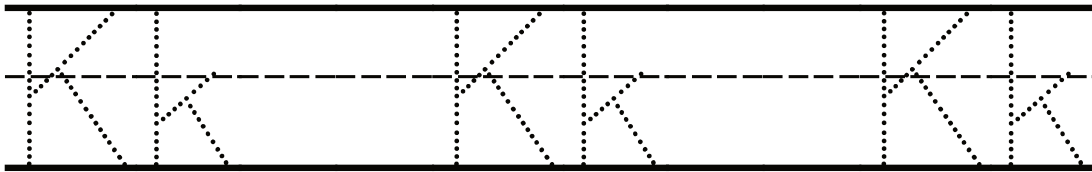
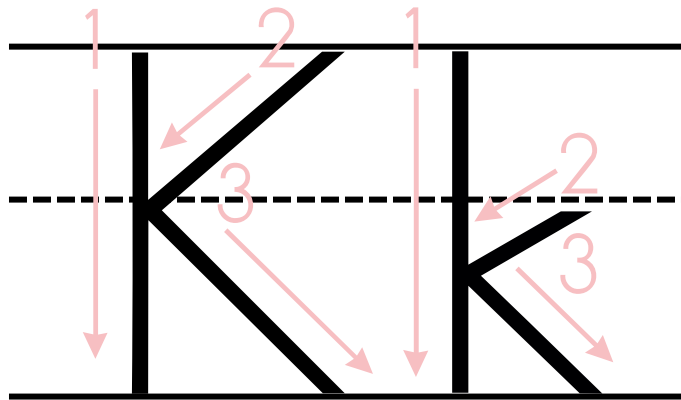

Name: _____

Date: _____

Trace the Letter

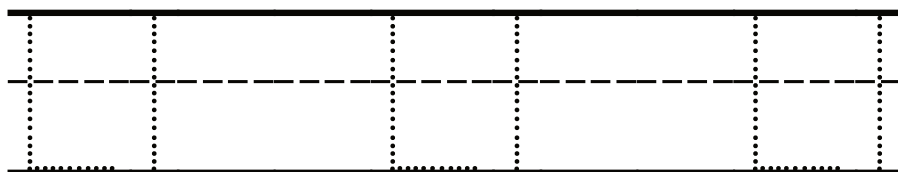
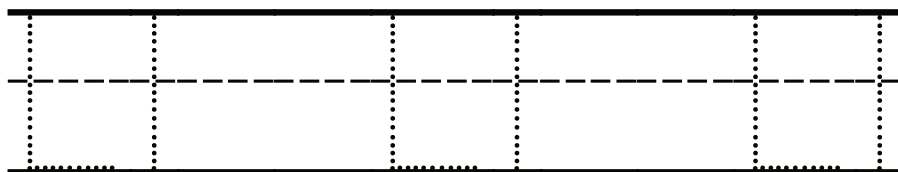
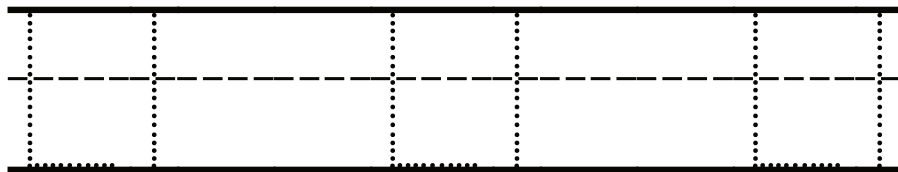
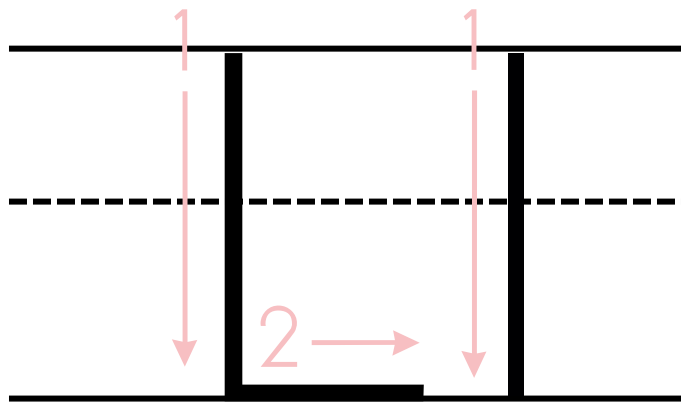

Name: _____

Date: _____

Trace the Letter

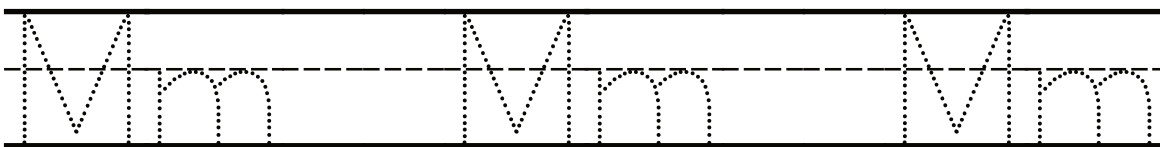
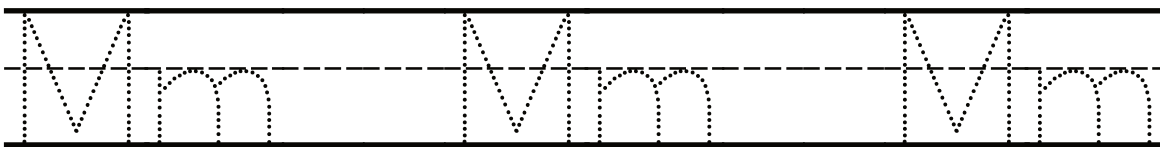
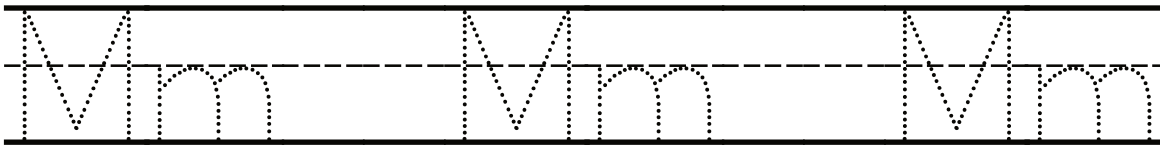
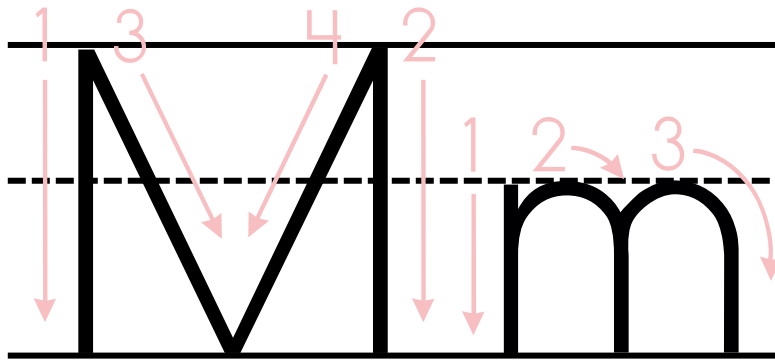

Name: _____

Date: _____

Trace the Letter

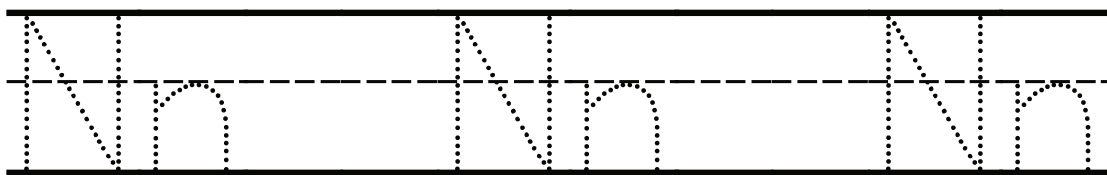
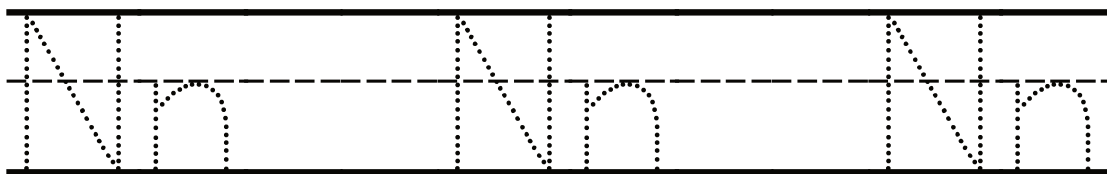
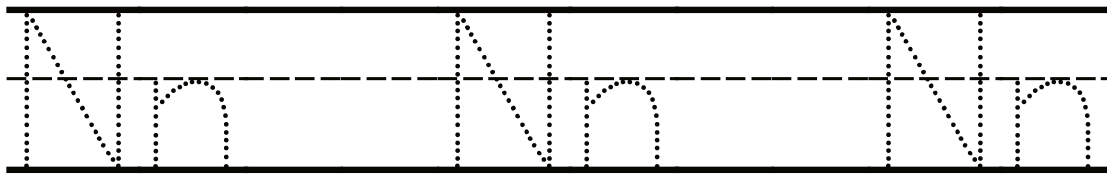
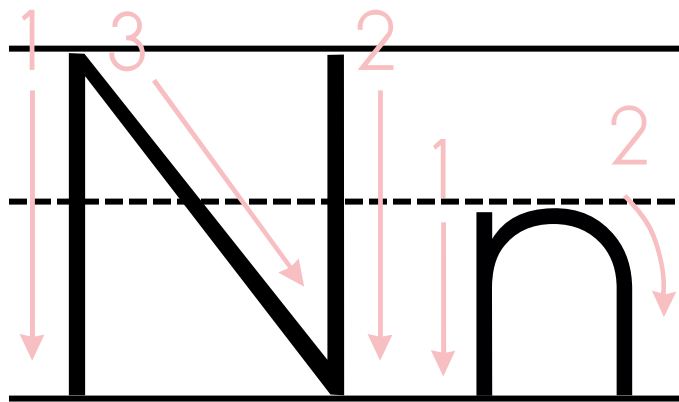

Name: _____

Date: _____

Trace the Letter

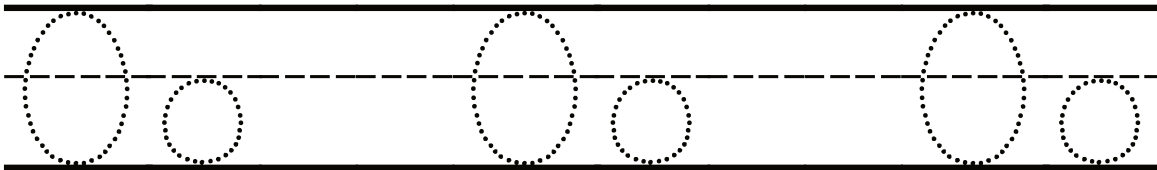
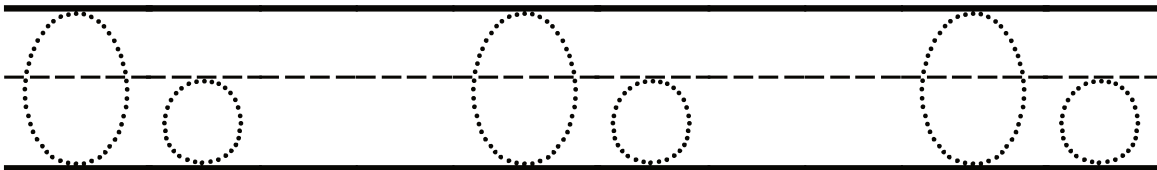
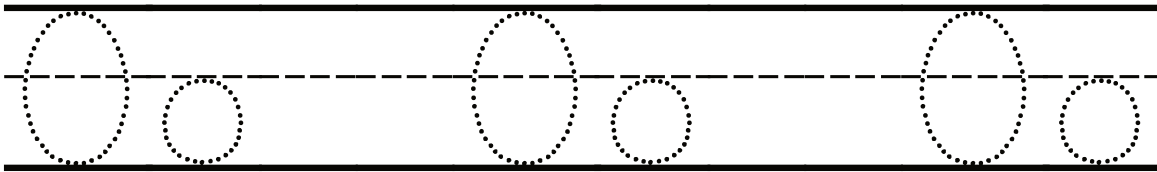
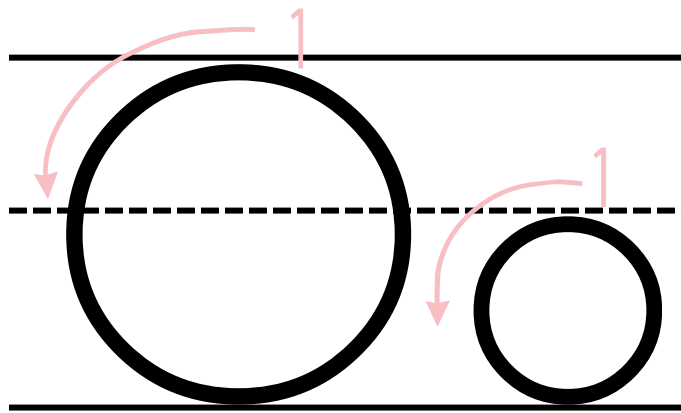

Name: _____

Date: _____

Trace the Letter

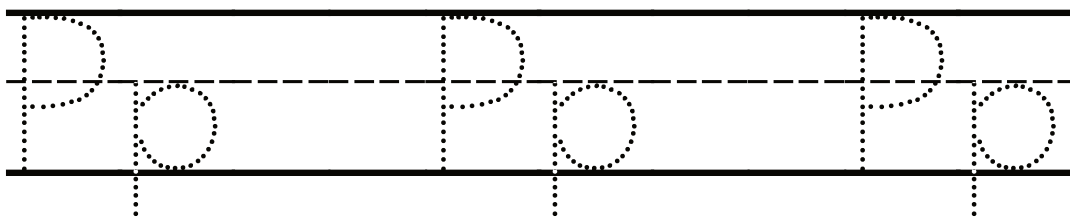
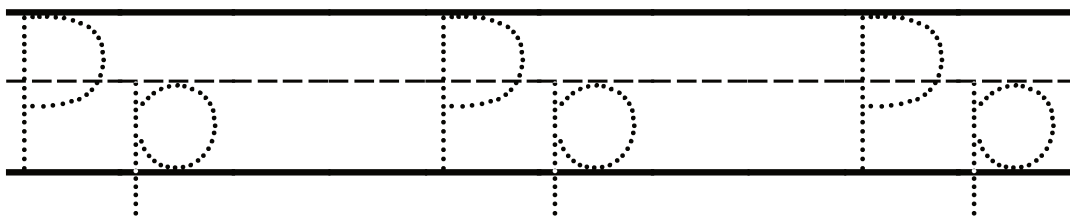
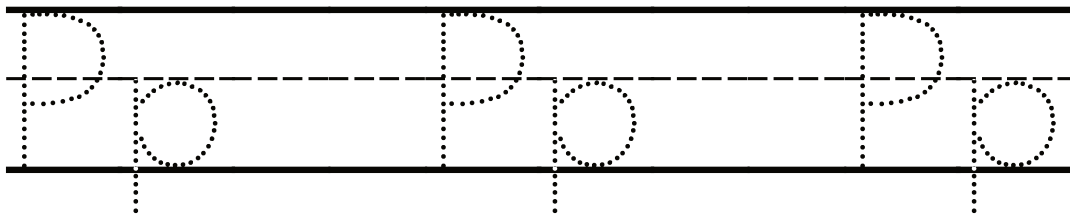
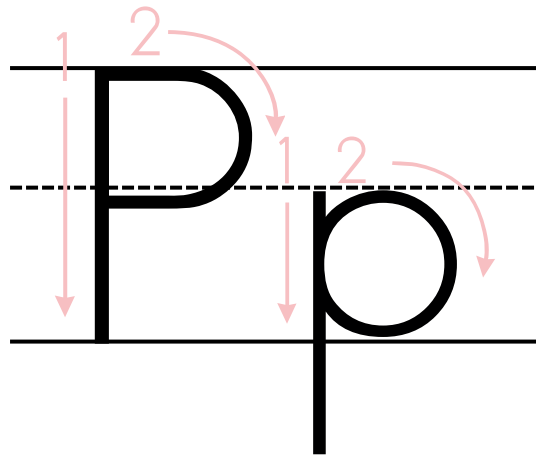

Name: _____

Date: _____

Trace the Letter

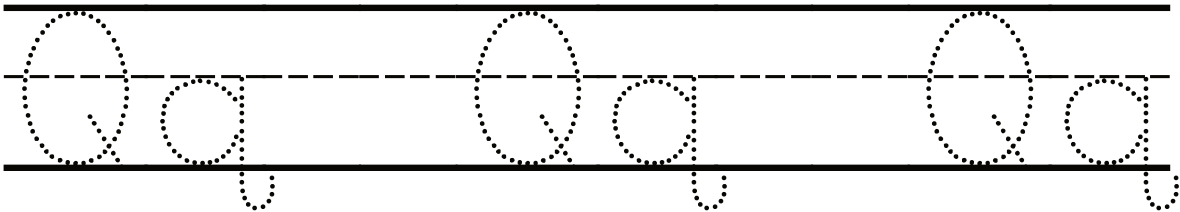
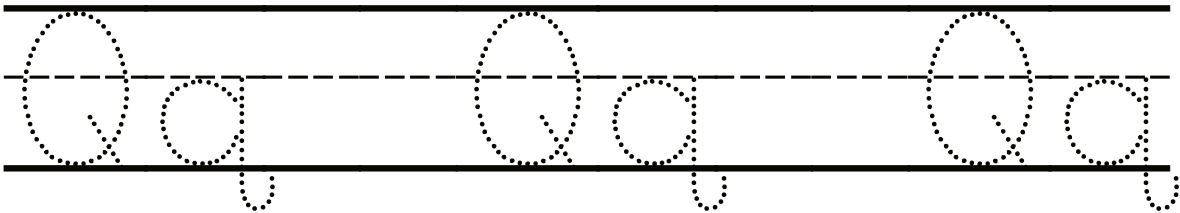
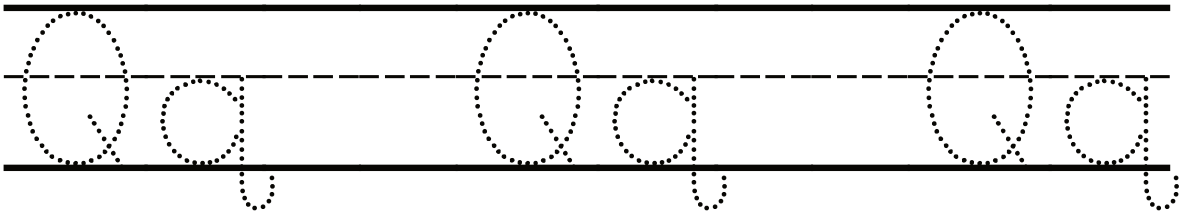
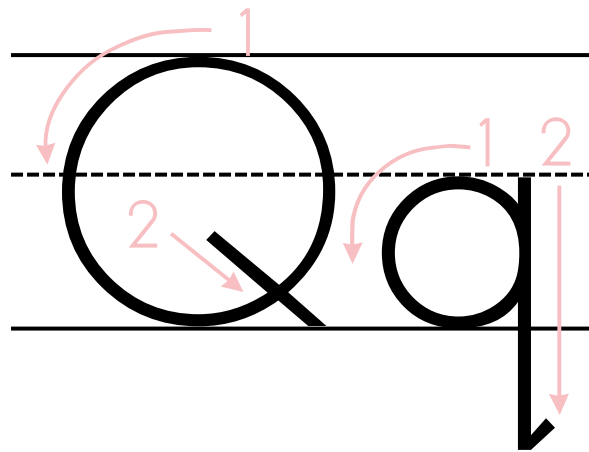

Name: _____

Date: _____

Trace the Letter

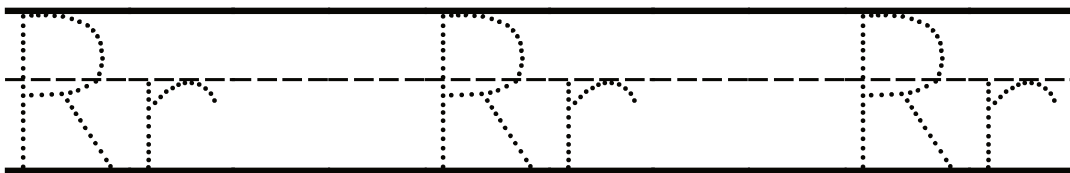
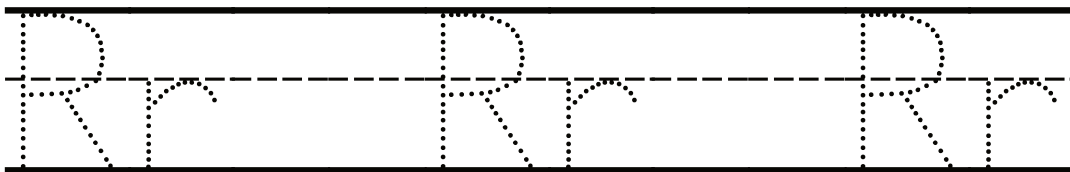
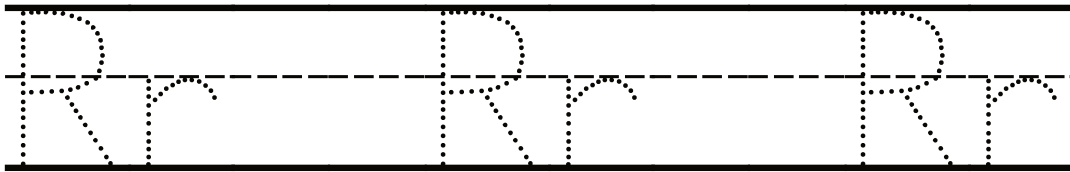
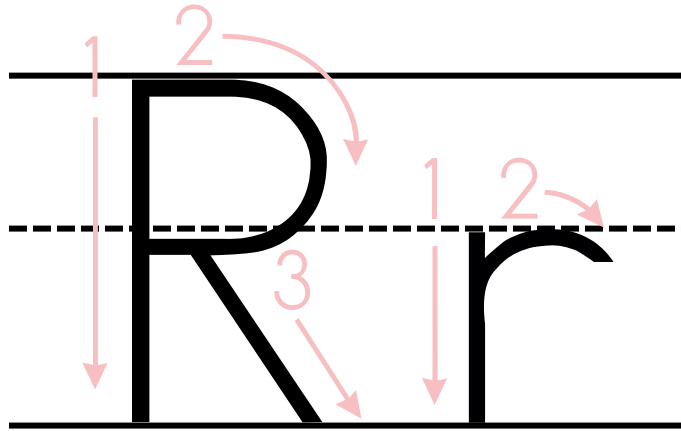

Name: _____

Date: _____

Trace the Letter

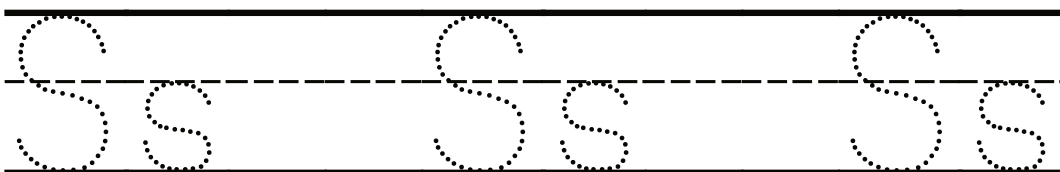
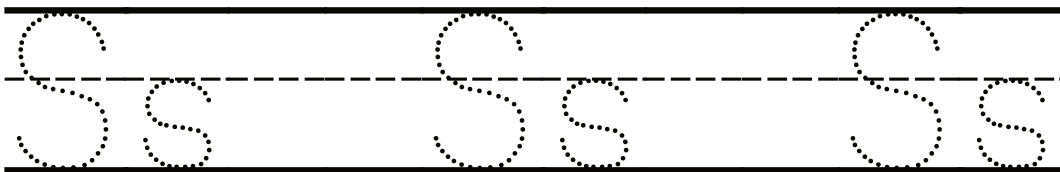
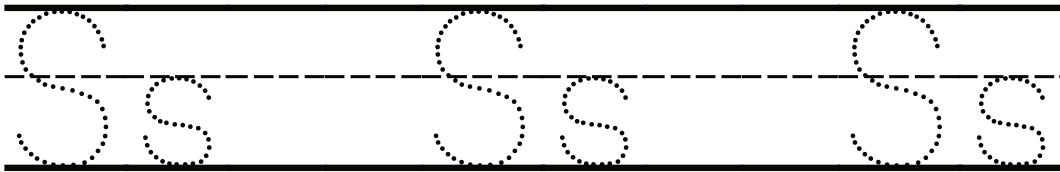
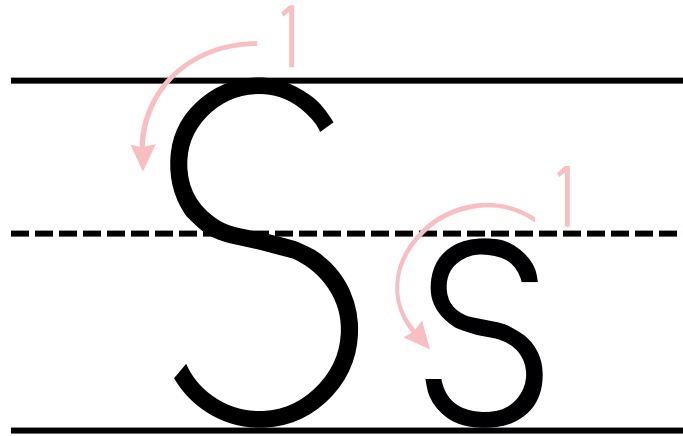

Name: _____

Date: _____

Trace the Letter

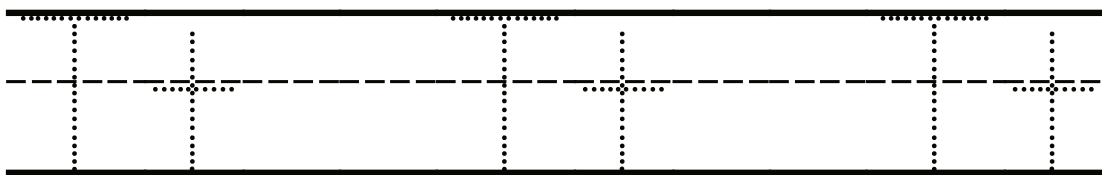
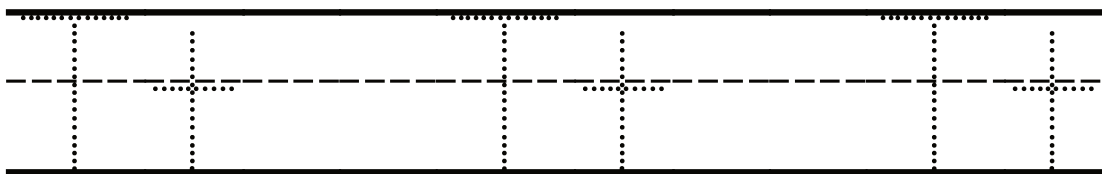
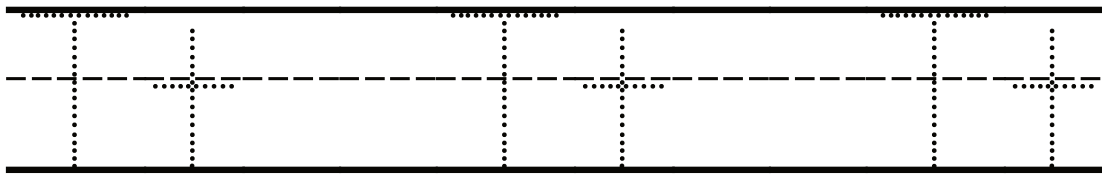
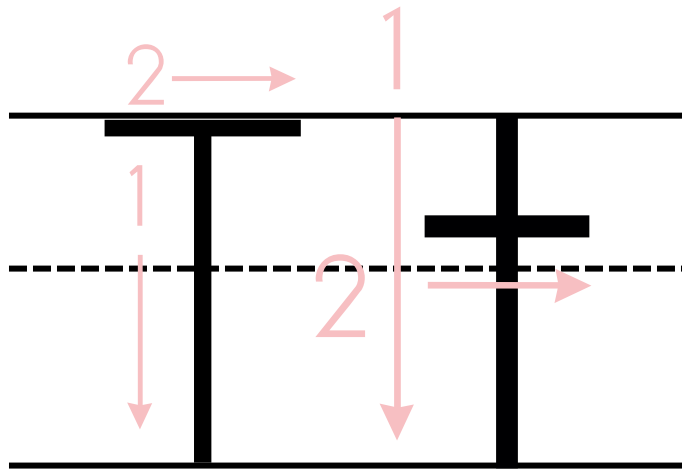

Name: _____

Date: _____

Trace the Letter

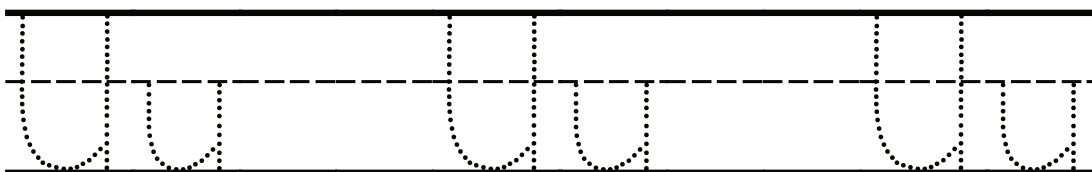
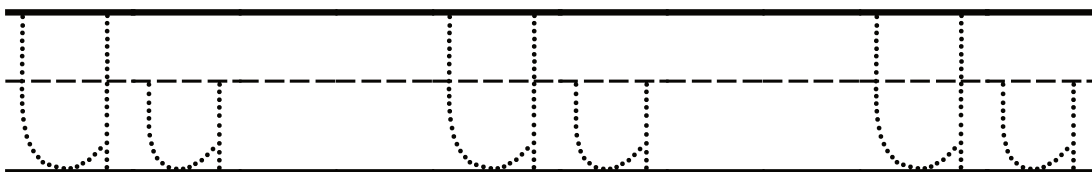
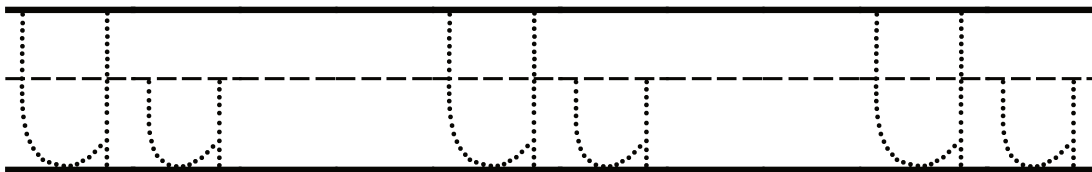
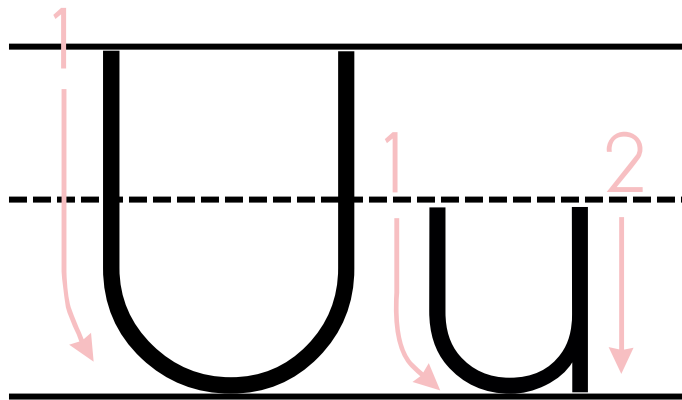

Name: _____

Date: _____

Trace the Letter

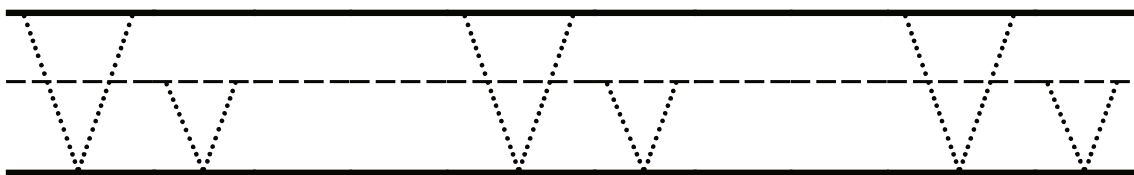
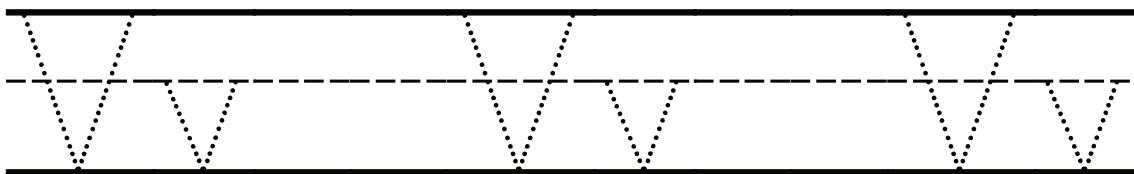
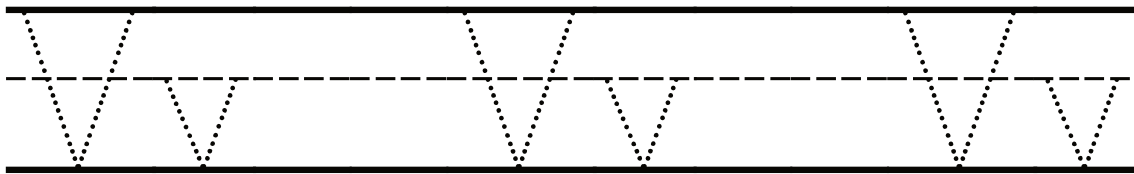
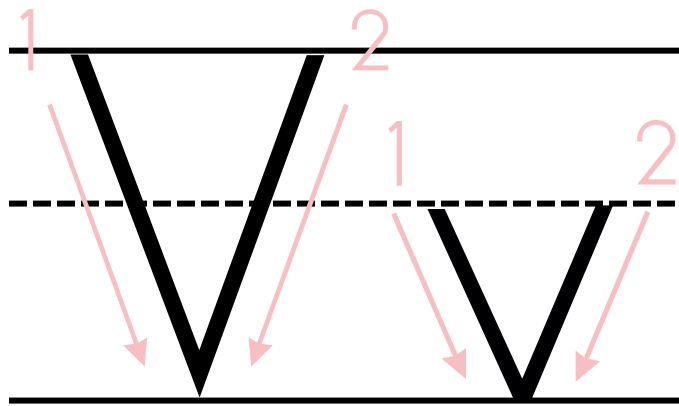

Name: _____

Date: _____

Trace the Letter

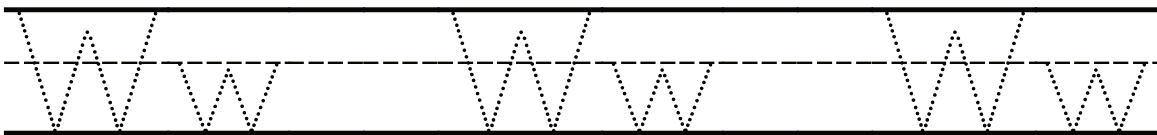
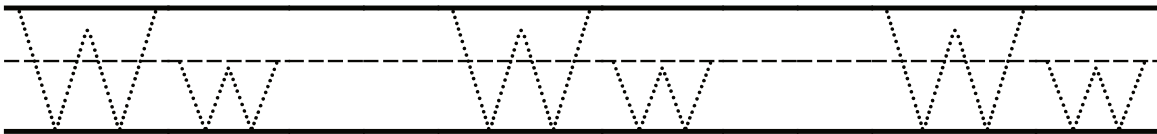
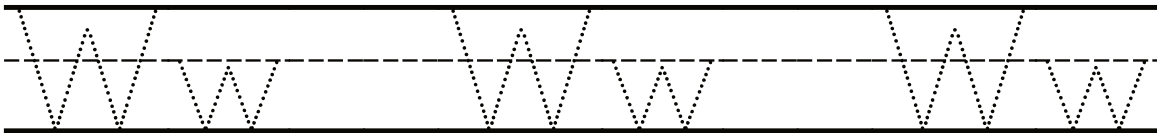
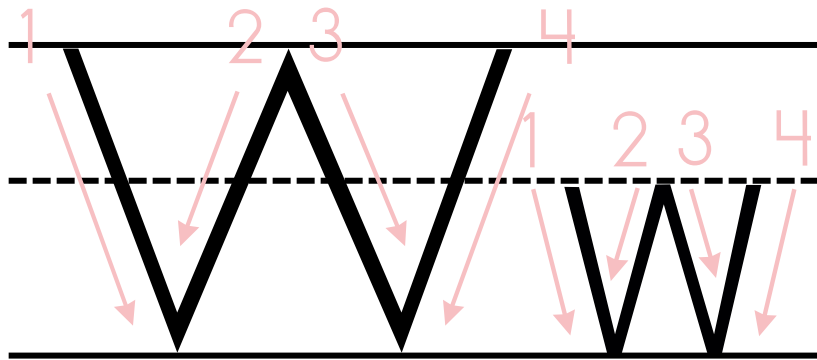

Name: _____

Date: _____

Trace the Letter

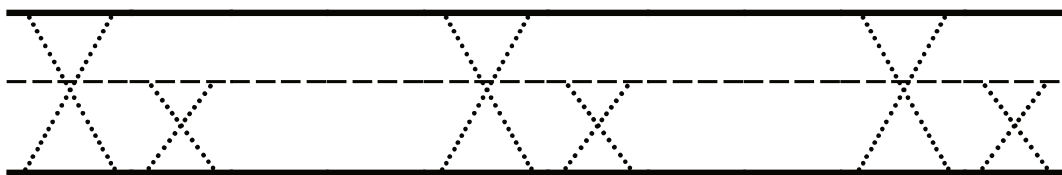
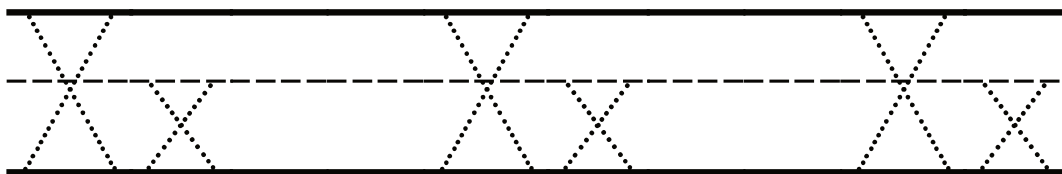
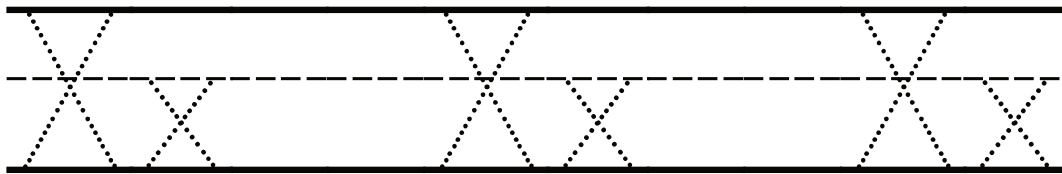
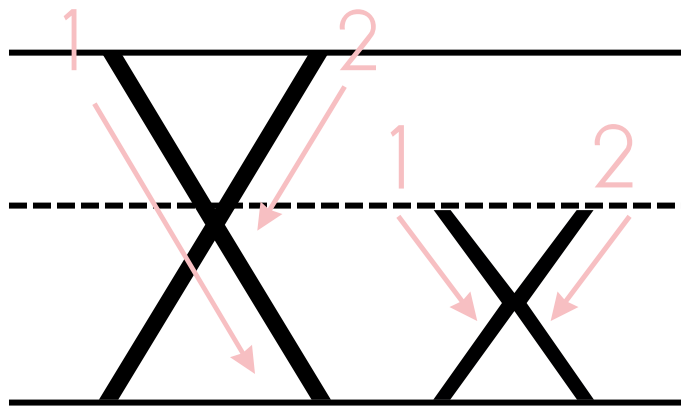

Name: _____

Date: _____

Trace the Letter

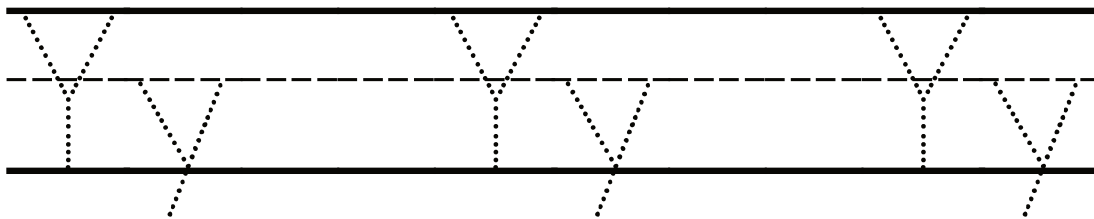
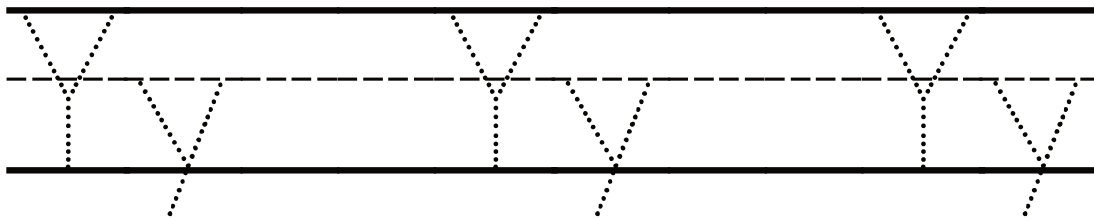
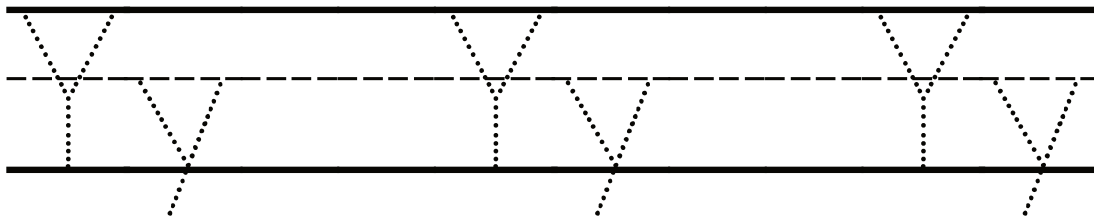
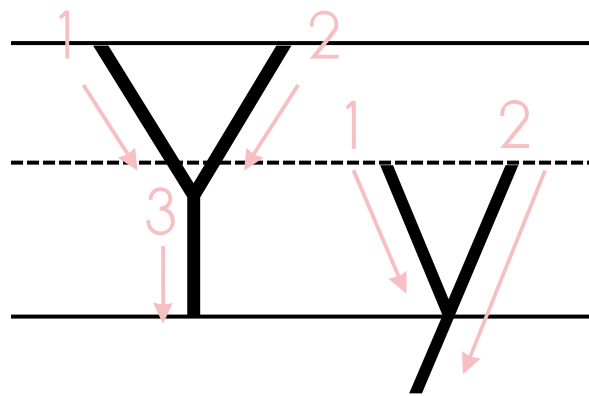

Name: _____

Date: _____

Trace the Letter

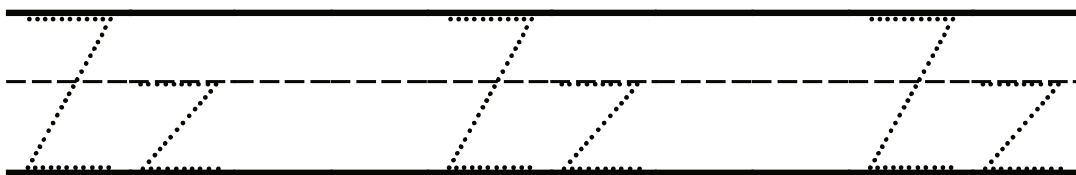
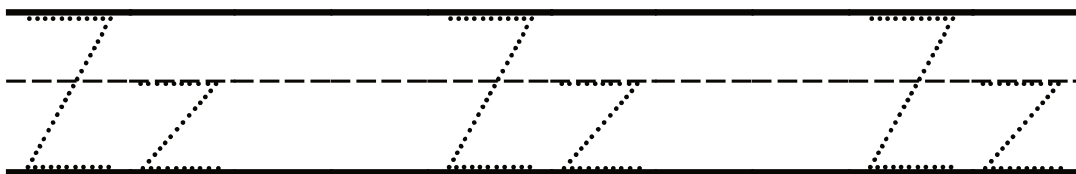
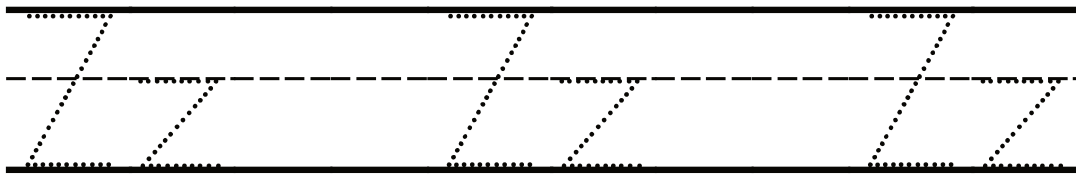
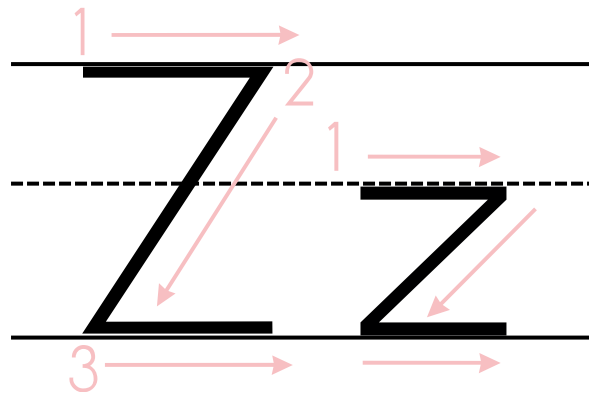

Sight Word Work

Name: _____

Date: _____

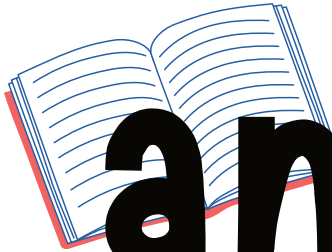

Read It!

and

Say the word out loud.

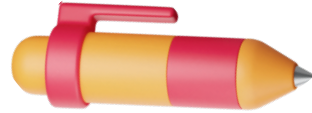

Write It!

Write the word.



Clap It!

How many syllables are in the word?
Color in the correct number.

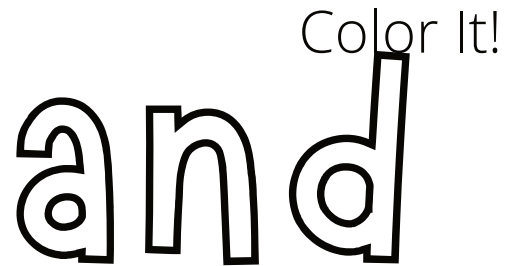

Color It!

Color in the word.



Trace It!

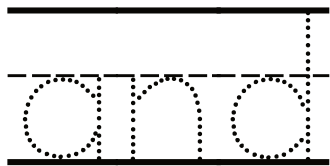

Trace the word.

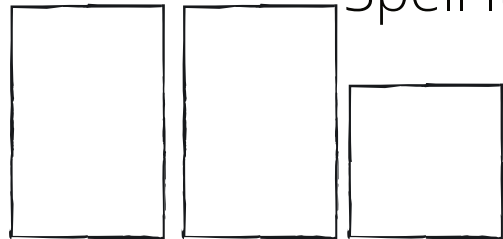

Spell It!

Spell the word.



Find It!

Find the word and color it in.

and

ant

and

arm

and

all



Tell It!

Who did you tell?

Go tell someone the word!

Sight Word Work

Name: _____

Date: _____

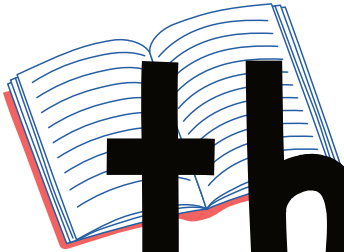

Read It!

the

Say the word out loud.

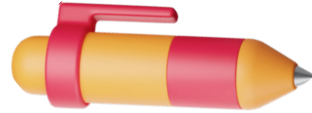

Write It!

Write the word.



Clap It!

How many syllables are in the word?
Color in the correct number.

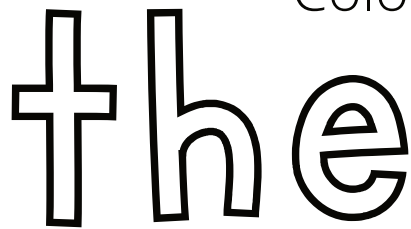

Color It!

Color in the word.



Trace It!

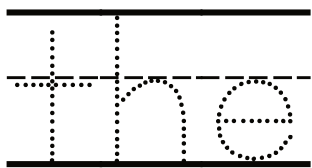

Trace the word.

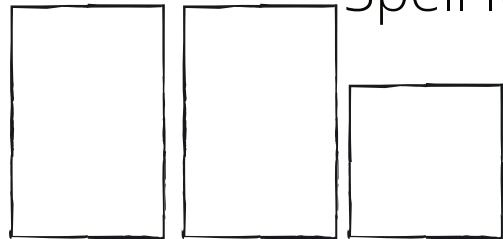

Spell It!

Spell the word.



Find It!

Find the word and color it in.

the

the

tag

to

ted

the



Tell It!

Who did you tell?

Go tell someone the word!

Sight Word Work

Name: _____

Date: _____

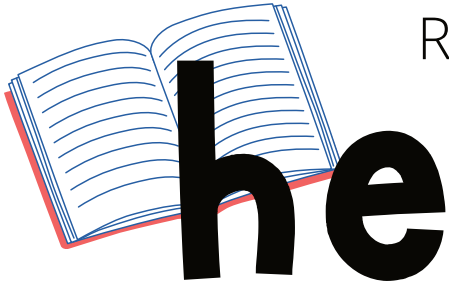

Read It!

Say the word out loud.

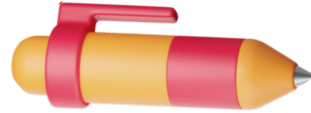

Write It!

Write the word.



Clap It!

How many syllables are in the word?
Color in the correct number.



Color It!

Color in the word.



Trace It!

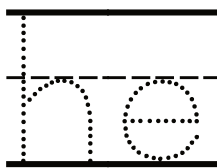

Trace the word.

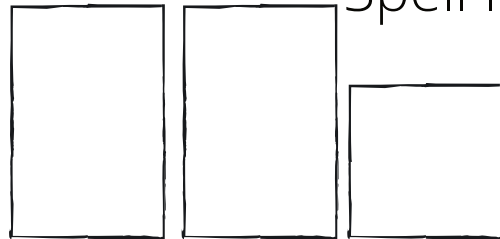

Spell It!

Spell the word.



Find It!

Find the word and color it in.

hi

he

he

he

hand

him



Tell It!

Who did you tell?

Go tell someone the word!

Sight Word Work

Name: _____

Date: _____

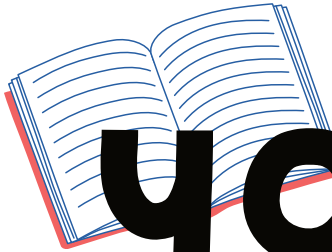

Read It!

you

Say the word out loud.

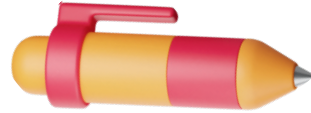

Write It!

Write the word.



Clap It!

How many syllables are in the word?
Color in the correct number.



Color It!

Color in the word.



Trace It!

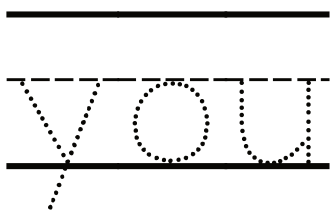

Trace the word.

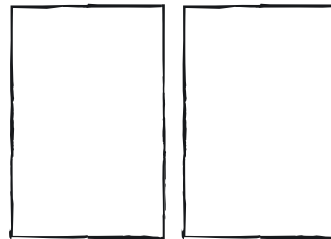

Spell It!

Spell the word.



Find It!

Find the word and color it in.

yes

yet

you

he

you

yak



Tell It!

Who did you tell?

Go tell someone the word!

Sight Word Work

Name: _____

Date: _____

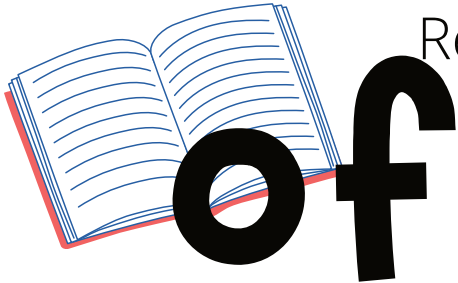

Read It!

Say the word out loud.

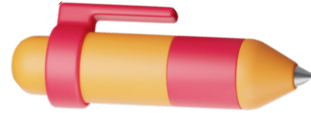

Write It!

Write the word.



Clap It!

How many syllables are in the word?
Color in the correct number.

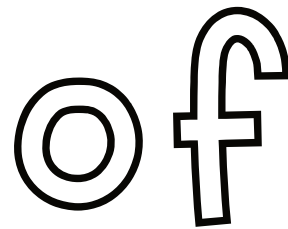

Color It!

Color in the word.



Trace It!

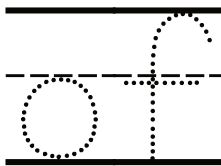

Trace the word.

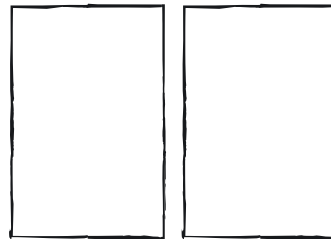

Spell It!

Spell the word.



Find It!

Find the word and color it in.

on

of

ok

of

off

of



Tell It!

Who did you tell?

Go tell someone the word!

Sight Word Work

Name: _____

Date: _____



Read It!

Say the word out loud.

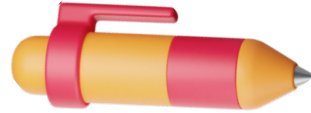

Write It!

Write the word.



Clap It!

How many syllables are in the word?
Color in the correct number.

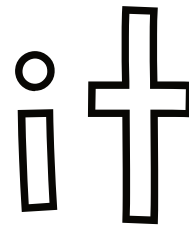

Color It!

Color in the word.



Trace It!

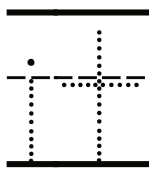

Trace the word.

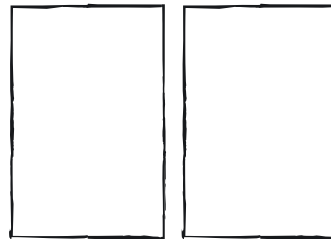

Spell It!

Spell the word.



Find It!

Find the word and color it in.

it

it

if

in

in

it



Tell It!

Who did you tell?

Go tell someone the word!

Sight Word Work

Name: _____

Date: _____

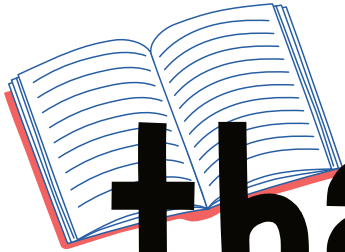

Read It!

that

Say the word out loud.

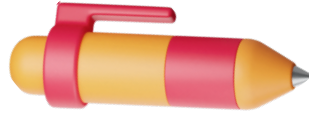

Write It!

Write the word.



Clap It!

How many syllables are in the word?
Color in the correct number.

Color It!

that

Color in the word.



Trace It!

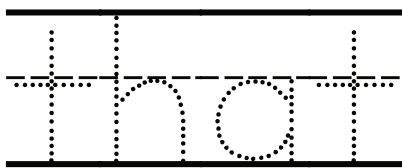

Trace the word.

Spell It!

--	--	--	--

Spell the word.



Find It!

Find the word and color it in.

Twit	that	that
that	Tree	Toss



Tell It!

Who did you tell?

Go tell someone the word!

Sight Word Work

Name: _____

Date: _____

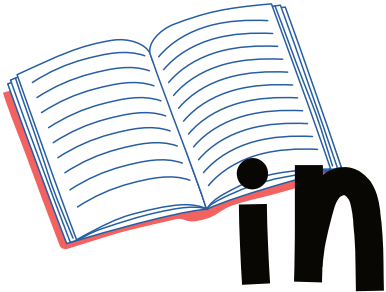

Read It!

Say the word out loud.

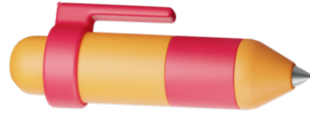

Write It!

Write the word.



Clap It!

How many syllables are in the word?
Color in the correct number.

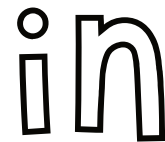

Color It!

Color in the word.



Trace It!

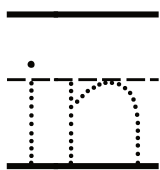

Trace the word.

Spell It!

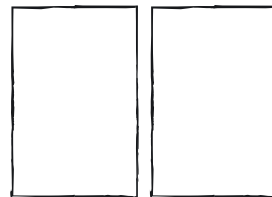

Spell the word.



Find It!

Find the word and color it in.

in

it

if

in

is

in



Tell It!

Who did you tell?

Go tell someone the word!

Sight Word Work

Name: _____

Date: _____

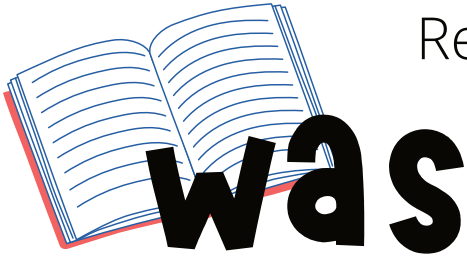

Read It!

Say the word out loud.

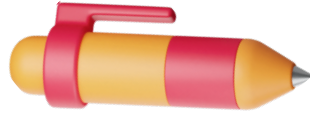

Write It!

Write the word.



How many syllables are in the word?
Color in the correct number.



Color It!

Color in the word.



Trace It!

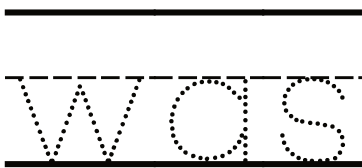

Trace the word.

Spell It!

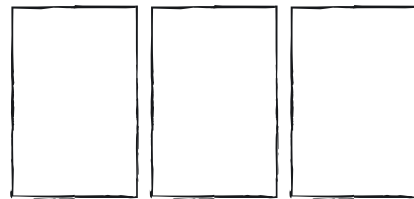

Spell the word.



Find It!

Find the word and color it in.

was

that

was

war

was

wan



Tell It!

Who did you tell?

Go tell someone the word!

Sight Word Work

Name: _____

Date: _____



Read It!

Say the word out loud.

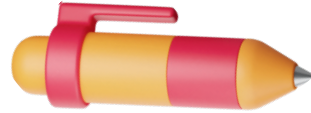

Write It!

Write the word.



Clap It!

How many syllables are in the word?
Color in the correct number.

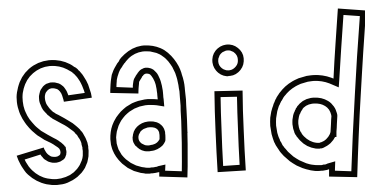

Color It!

Color in the word.



Trace It!

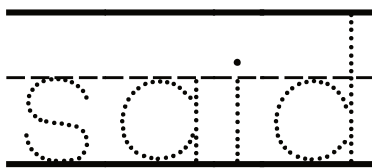

Trace the word.

Spell It!

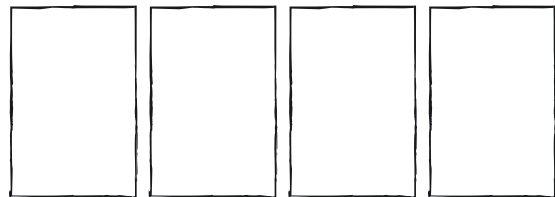

Spell the word.



Find It!

Find the word and color it in.

said

said

Shoe

said

Side

Salt



Tell It!

Who did you tell?

Go tell someone the word!

Sight Word Work

Name: _____

Date: _____

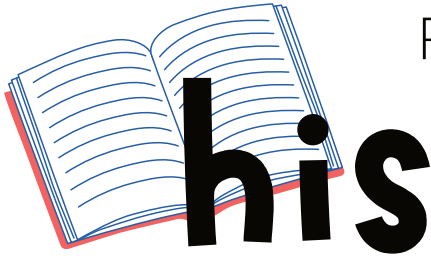

Read It!

Say the word out loud.

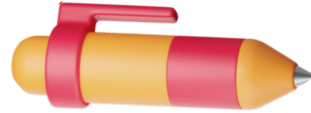

Write It!

Write the word.



Clap It!

How many syllables are in the word?
Color in the correct number.

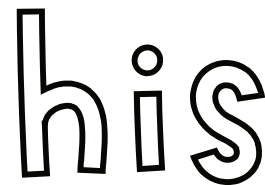

Color It!

Color in the word.



Trace It!

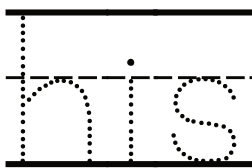

Trace the word.

Spell It!

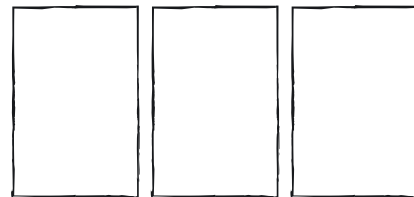

Spell the word.



Find It!

Find the word and color it in.

him

his

her

his

hut

his



Tell It!

Who did you tell?

Go tell someone the word!

Sight Word Work

Name: _____

Date: _____

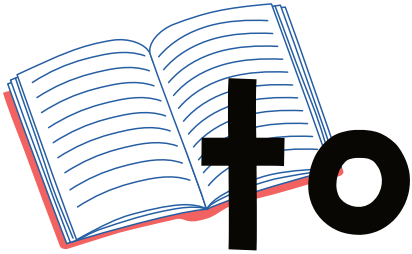

Read It!

Say the word out loud.

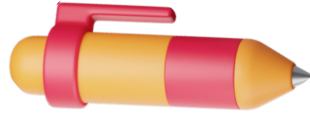

Write It!

Write the word.



Clap It!

How many syllables are in the word?
Color in the correct number.

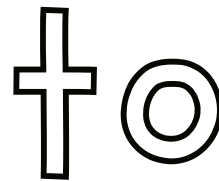

Color It!

Color in the word.



Trace It!

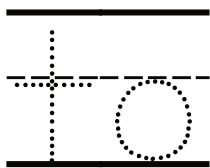

Trace the word.

Spell It!

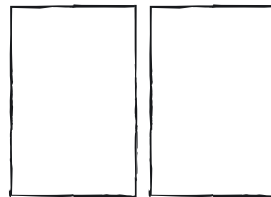

Spell the word.



Find It!

Find the word and color it in.

to

ta

to

to

th

tj



Tell It!

Who did you tell?

Go tell someone the word!

Sight Word Work

Name: _____

Date: _____

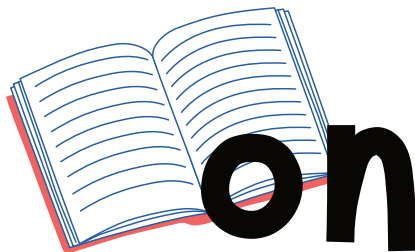

Read It!

Say the word out loud.

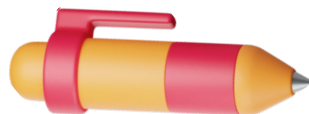

Write It!

Write the word.



Clap It!

How many syllables are in the word?
Color in the correct number.



Color It!

Color in the word.



Trace It!

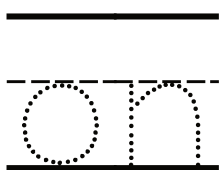

Trace the word.

Spell It!

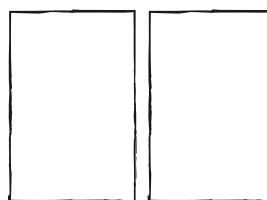

Spell the word.



Find It!

Find the word and color it in.

to

on

mo

on

on

no



Tell It!

Who did you tell?

Go tell someone the word!

Sight Word Work

Name: _____

Date: _____

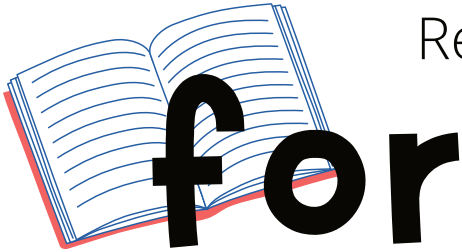

Read It!

for

Say the word out loud.

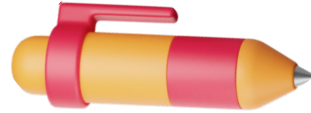

Write It!

Write the word.



Clap It!

How many syllables are in the word?
Color in the correct number.

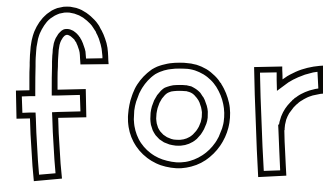

Color It!

Color in the word.



Trace It!

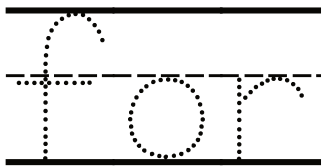

Trace the word.

Spell It!

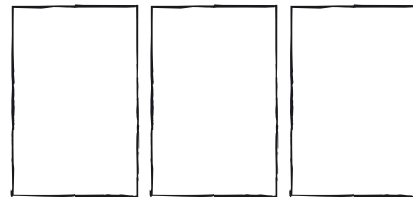

Spell the word.



Find It!

Find the word and color it in.

for	for	fab
for	fam	for



Tell It!

Who did you tell?



Go tell someone the word!

Sight Word Work

Name: _____

Date: _____

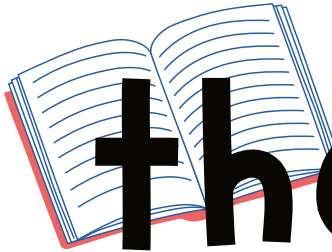

Read It!

they

Say the word out loud.

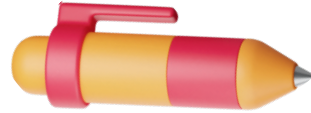

Write It!

Write the word.



Clap It!

How many syllables are in the word?
Color in the correct number.

Color It!

they

Color in the word.



Trace It!

they

Trace the word.

Spell It!

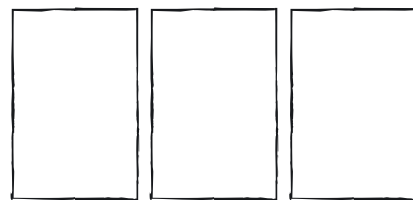

Spell the word.



Find It!

Find the word and color it in.

Thud

they

Temp

they

Trek

they



Tell It!

Who did you tell?

Go tell someone the word!

Sight Word Work

Name: _____

Date: _____

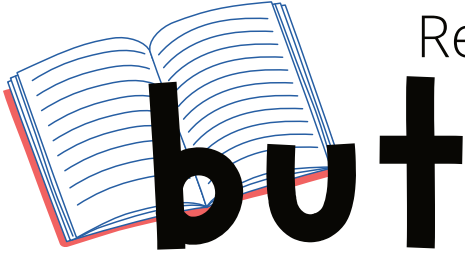

Read It!

Say the word out loud.

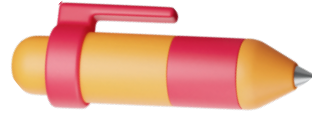

Write It!

Write the word.



Clap It!

How many syllables are in the word?
Color in the correct number.



Color It!

Color in the word.



Trace It!

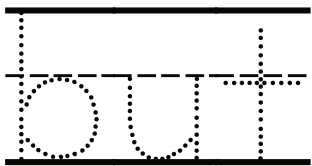

Trace the word.

Spell It!

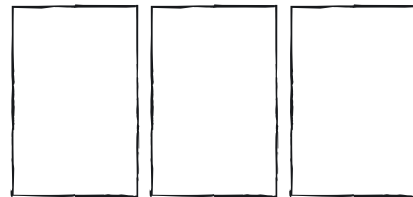

Spell the word.



Find It!

Find the word and color it in.

but

bad

bat

bag

but

but



Tell It!

Who did you tell?

Go tell someone the word!

Sight Word Work

Name: _____

Date: _____

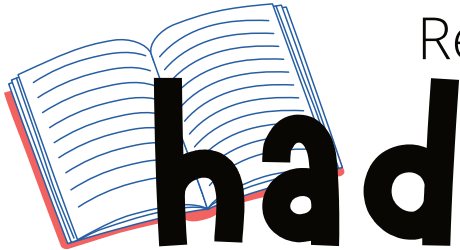

Read It!

Say the word out loud.

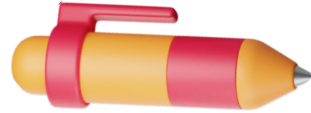

Write It!

Write the word.



Clap It!

How many syllables are in the word?
Color in the correct number.



Color It!

Color in the word.



Trace It!

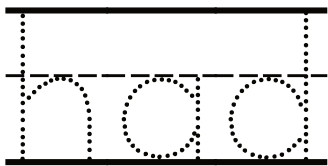

Trace the word.

Spell It!



Spell the word.



Find It!

Find the word and color it in.

hen

had

hem

had

had

har



Tell It!

Who did you tell?

Go tell someone the word!

Sight Word Work

Name: _____

Date: _____

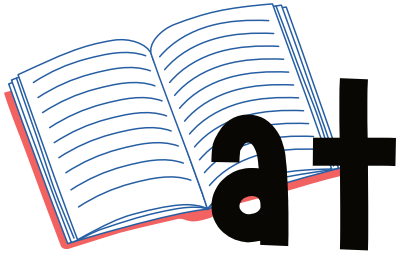

Read It!

Say the word out loud.

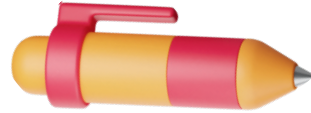

Write It!

Write the word.



Clap It!

How many syllables are in the word?
Color in the correct number.

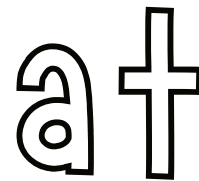

Color It!

Color in the word.



Trace It!

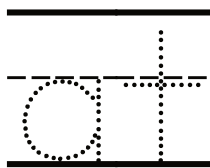

Trace the word.

Spell It!

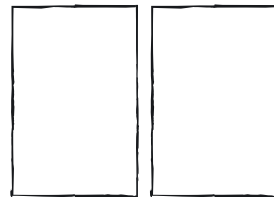

Spell the word.



Find It!

Find the word and color it in.

at

at

as

am

at

an



Tell It!

Who did you tell?

Go tell someone the word!

Sight Word Work

Name: _____

Date: _____



Read It!

Say the word out loud.

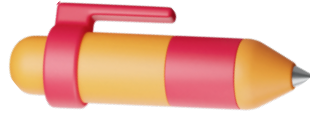

Write It!

Write the word.



Clap It!

How many syllables are in the word?
Color in the correct number.

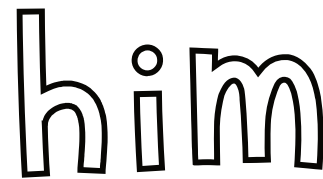

Color It!

Color in the word.



Trace It!

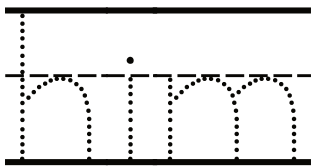

Trace the word.

Spell It!

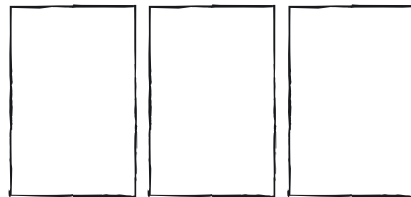

Spell the word.



Find It!

Find the word and color it in.

him

had

hat

his

him

him



Tell It!

Who did you tell?

Go tell someone the word!

Sight Word Work

Name: _____

Date: _____

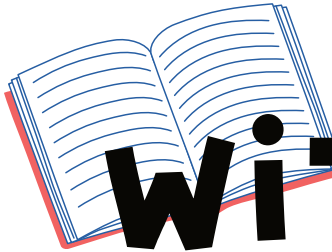

Read It!

with

Say the word out loud.

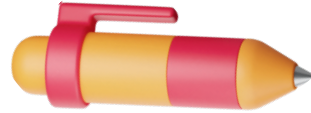

Write It!

Write the word.



Clap It!

How many syllables are in the word?
Color in the correct number.

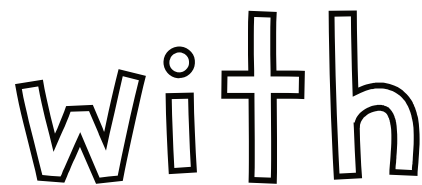

Color It!

Color in the word.



Trace It!

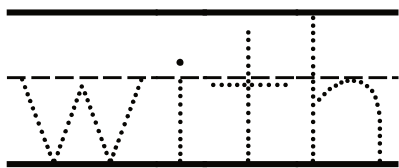

Trace the word.

Spell It!

--	--	--	--

Spell the word.



Find It!

Find the word and color it in.

wack	with	with
with	wadi	wady



Tell It!

Who did you tell?

Go tell someone the word!

Sight Word Work

Name: _____

Date: _____

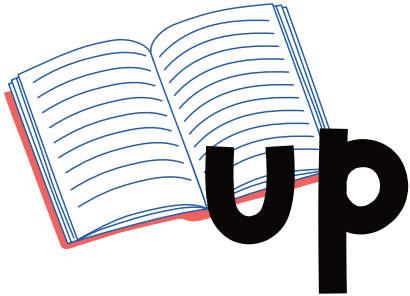

Read It!

Say the word out loud.

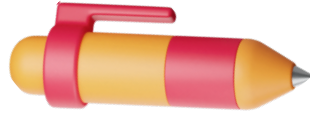

Write It!

Write the word.



Clap It!

How many syllables are in the word?
Color in the correct number.

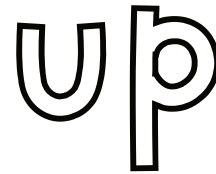

Color It!

Color in the word.



Trace It!

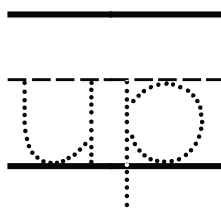

Trace the word.

Spell It!

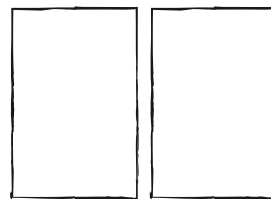

Spell the word.



Find It!

Find the word and color it in.

up

um

un

up

up

du



Tell It!

Who did you tell?

Go tell someone the word!

Sight Word Work

Name: _____

Date: _____

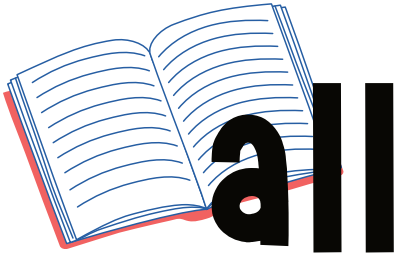

Read It!

Say the word out loud.

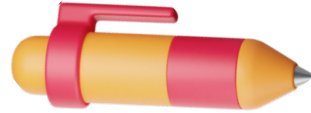

Write It!

Write the word.



Clap It!

How many syllables are in the word?
Color in the correct number.

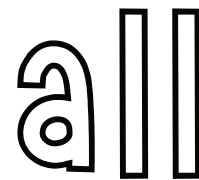

Color It!

Color in the word.



Trace It!

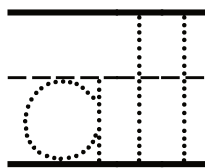

Trace the word.

Spell It!

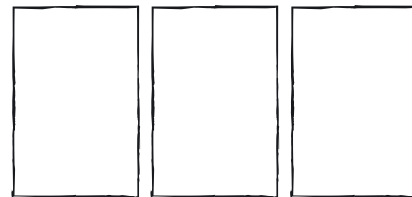

Spell the word.



Find It!

Find the word and color it in.

all

as

all

all

at

an



Tell It!

Who did you tell?

Go tell someone the word!

Sight Word Work

Name: _____

Date: _____

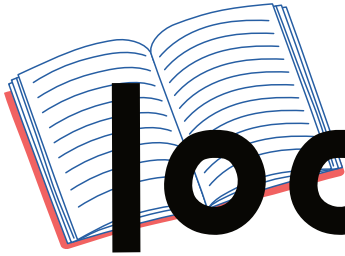

Read It!

look

Say the word out loud.

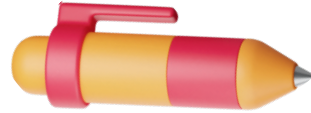

Write It!

Write the word.



Clap It!

How many syllables are in the word?
Color in the correct number.

Color It!

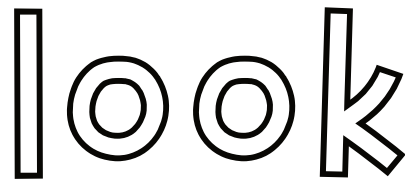

Color in the word.



Trace It!

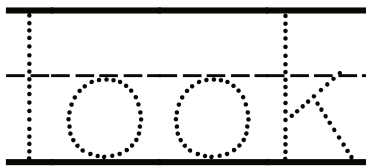

Trace the word.

Spell It!

--	--	--	--

Spell the word.



Find It!

Find the word and color it in.

Lamp	look	look
look	Lily	Link



Tell It!

Who did you tell?

Go tell someone the word!

Sight Word Work

Name: _____

Date: _____



Read It!

Say the word out loud.

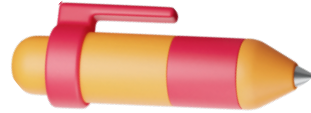

Write It!

Write the word.



How many syllables are in the word?
Color in the correct number.

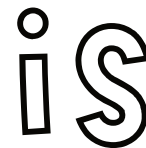

Color It!

Color in the word.



Trace It!

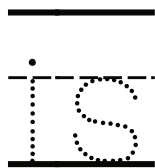

Trace the word.

Spell It!

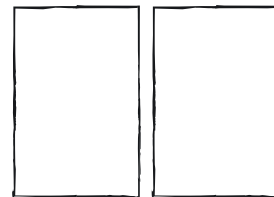

Spell the word.



Find It!

Find the word and color it in.

is

in

if

is

is

it



Tell It!

Who did you tell?

Go tell someone the word!

Sight Word Work

Name: _____

Date: _____



Read It!

Say the word out loud.

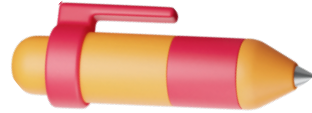

Write It!

Write the word.



Clap It!

How many syllables are in the word?
Color in the correct number.



Color It!

Color in the word.



Trace It!

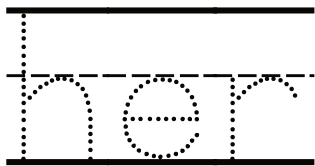

Trace the word.

Spell It!



Spell the word.



Find It!

Find the word and color it in.

has

her

hap

her

her

han



Tell It!

Who did you tell?

Go tell someone the word!

Sight Word Work

Name: _____

Date: _____



Read It!

there

Say the word out loud.

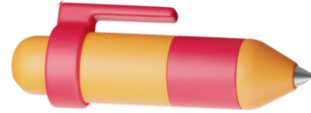

Write It!

Write the word.



Clap It!

How many syllables are in the word?
Color in the correct number.

Color It!

there

Color in the word.



Trace It!

there

Trace the word.

Spell It!

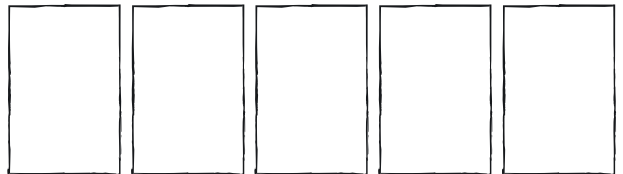

Spell the word.



Find It!

Find the word and color it in.

there

there

taboo

tabby

there

table



Tell It!

Who did you tell?

Go tell someone the word!

Sight Word Work

Name: _____

Date: _____

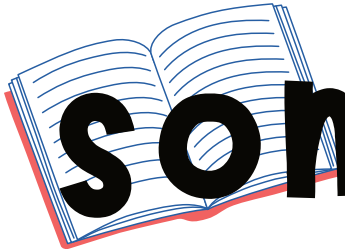

Read It!

some

Say the word out loud.

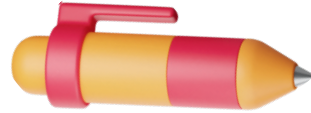

Write It!

Write the word.



Clap It!

How many syllables are in the word?
Color in the correct number.

Color It!

some

Color in the word.



Trace It!

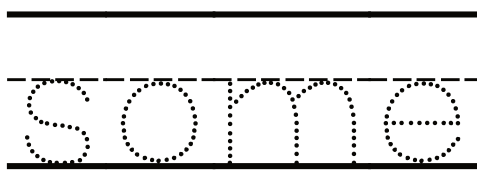

Trace the word.

Spell It!

--	--	--	--

Spell the word.



Find It!

Find the word and color it in.

Shot	some	some
some	Swim	Ship



Tell It!

Who did you tell?

Go tell someone the word!

Sight Word Work

Name: _____

Date: _____

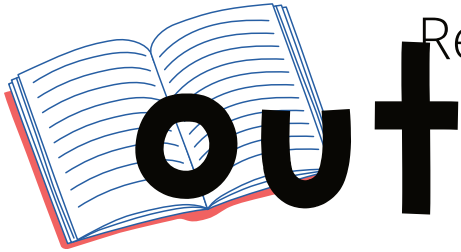

Read It!

Say the word out loud.

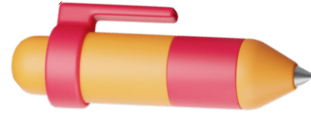

Write It!

Write the word.



Clap It!

How many syllables are in the word?
Color in the correct number.

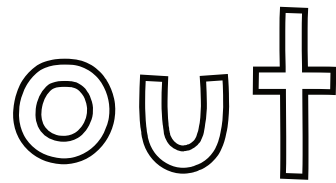

Color It!

Color in the word.



Trace It!

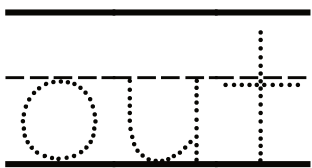

Trace the word.

Spell It!



Spell the word.



Find It!

Find the word and color it in.

out

oil

own

ons

out

out



Tell It!

Who did you tell?

Go tell someone the word!

Sight Word Work

Name: _____

Date: _____

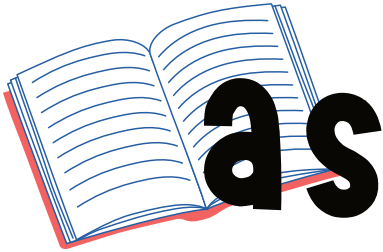

Read It!

Say the word out loud.

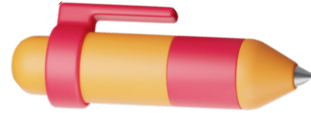

Write It!

Write the word.



Clap It!

How many syllables are in the word?
Color in the correct number.



Color It!

Color in the word.



Trace It!

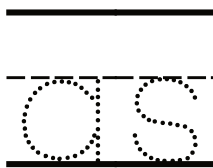

Trace the word.

Spell It!

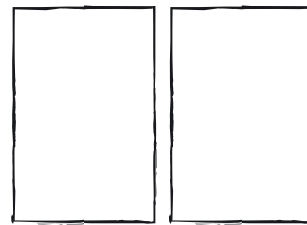

Spell the word.



Find It!

Find the word and color it in.

at

as

am

as

an

as



Tell It!

Who did you tell?

Go tell someone the word!

Sight Word Work

Name: _____

Date: _____

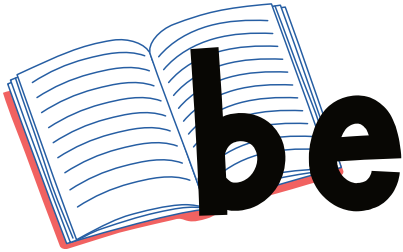

Read It!

Say the word out loud.

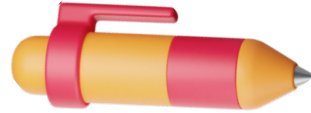

Write It!

Write the word.



Clap It!

How many syllables are in the word?
Color in the correct number.

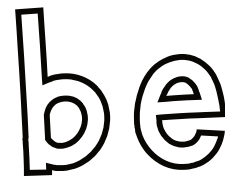

Color It!

Color in the word.



Trace It!

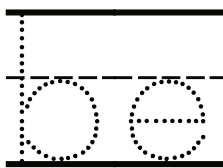

Trace the word.

Spell It!

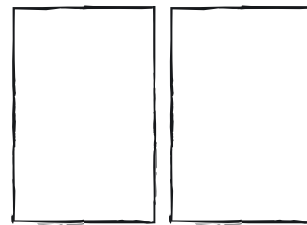

Spell the word.



Find It!

Find the word and color it in.

be

be

bee

so

be

no



Tell It!

Who did you tell?

Go tell someone the word!

Sight Word Work

Name: _____

Date: _____

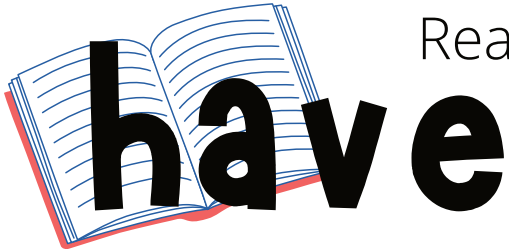

Read It!

Say the word out loud.

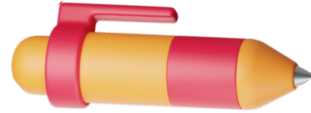

Write It!

Write the word.



Clap It!

How many syllables are in the word?
Color in the correct number.



Color It!

Color in the word.



Trace It!

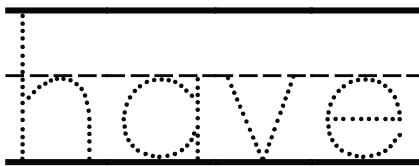

Trace the word.

Spell It!

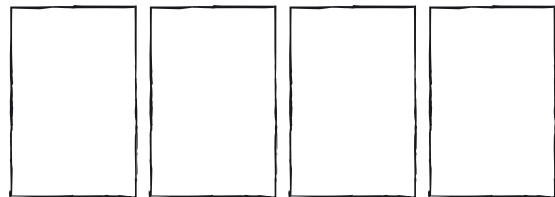

Spell the word.



Find It!

Find the word and color it in.

have

had

have

has

have

hand



Tell It!

Who did you tell?

Go tell someone the word!

Sight Word Work

Name: _____

Date: _____

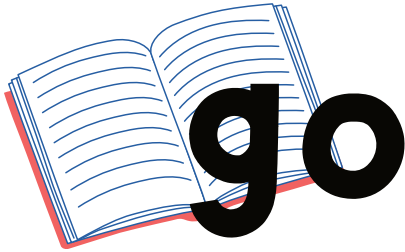

Read It!

Say the word out loud.

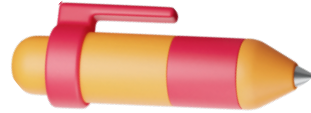

Write It!

Write the word.



Clap It!

How many syllables are in the word?
Color in the correct number.



Color It!

Color in the word.



Trace It!

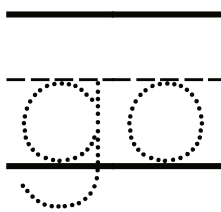

Trace the word.

Spell It!

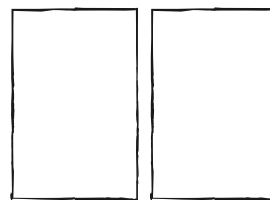

Spell the word.



Find It!

Find the word and color it in.

go

goal

gone

got

go

go



Tell It!

Who did you tell?

Go tell someone the word!

Sight Word Work

Name: _____

Date: _____

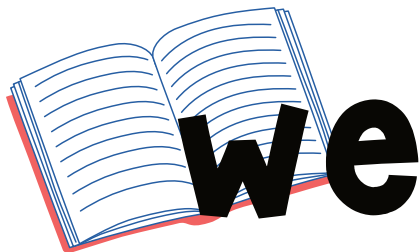

Read It!

Say the word out loud.

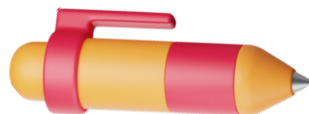

Write It!

Write the word.



Clap It!

How many syllables are in the word?
Color in the correct number.



Color It!

Color in the word.



Trace It!

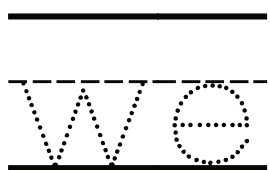

Trace the word.

Spell It!

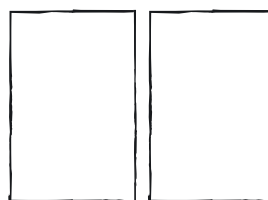

Spell the word.



Find It!

Find the word and color it in.

we

went

on

we

gift

go



Tell It!

Who did you tell?

Go tell someone the word!

Sight Word Work

Name: _____

Date: _____

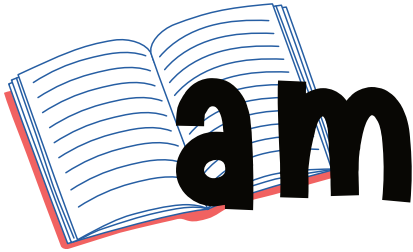

Read It!

Say the word out loud.

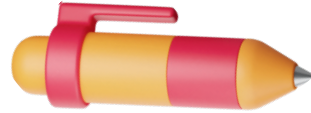

Write It!

Write the word.



Clap It!

How many syllables are in the word?
Color in the correct number.



Color It!

Color in the word.



Trace It!

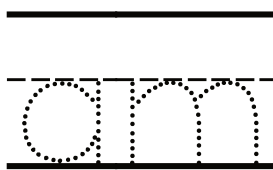

Trace the word.

Spell It!

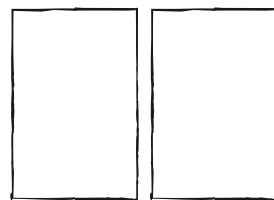

Spell the word.



Find It!

Find the word and color it in.

an

am

off

am

all

am



Tell It!

Who did you tell?

Go tell someone the word!

Sight Word Work

Name: _____

Date: _____

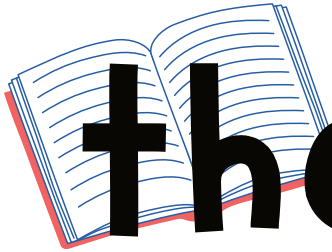

Read It!

then

Say the word out loud.

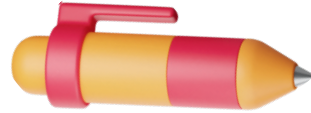

Write It!

Write the word.



Clap It!

How many syllables are in the word?
Color in the correct number.

Color It!

then

Color in the word.



Trace It!

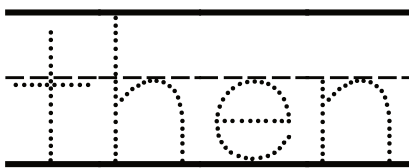

Trace the word.

Spell It!

--	--	--	--

Spell the word.



Find It!

Find the word and color it in.

then	the	thank
then	tell	then



Tell It!

Who did you tell?

Go tell someone the word!

Sight Word Work

Name: _____

Date: _____



Say the word out loud.

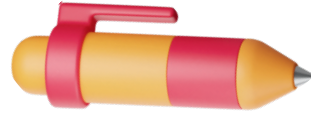

Write the word.



How many syllables are in the word?
Color in the correct number.

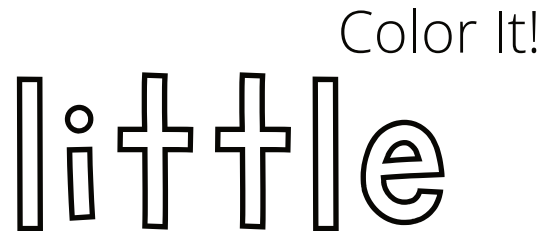

Color in the word.

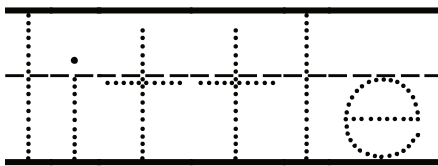
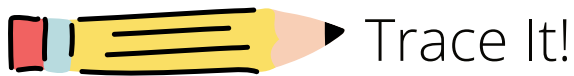

Trace the word.

Spell It!

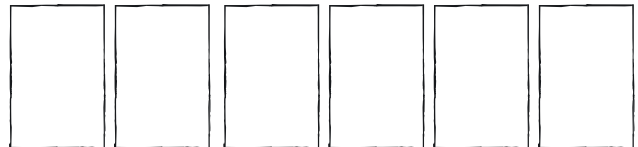

Spell the word.



Find the word and color it in.

little

then

luck

little

ten

little



Who did you tell?

Go tell someone the word!

Sight Word Work

Name: _____

Date: _____

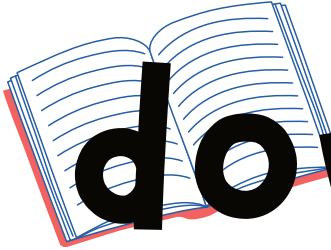

Read It!

down

Say the word out loud.

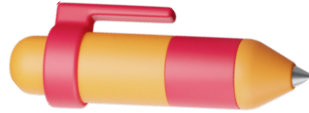

Write It!

Write the word.



Clap It!

How many syllables are in the word?
Color in the correct number.

down

Color It!

Color in the word.



Trace It!

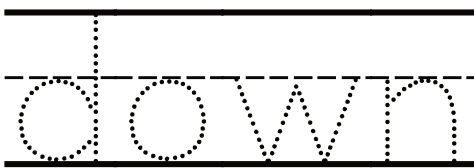

Trace the word.

Spell It!

--	--	--	--

Spell the word.



Find It!

Find the word and color it in.

down	down	duck
doll	down	dog



Tell It!

Who did you tell?

Go tell someone the word!

Sight Word Work

Name: _____

Date: _____

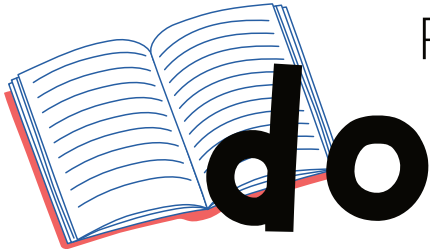

Read It!

Say the word out loud.

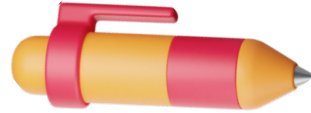

Write It!

Write the word.



Clap It!

How many syllables are in the word?
Color in the correct number.

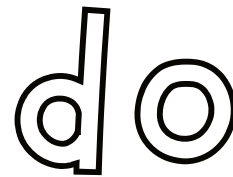

Color It!

Color in the word.



Trace It!

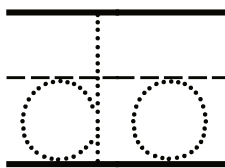

Trace the word.

Spell It!

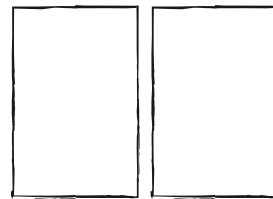

Spell the word.



Find It!

Find the word and color it in.

do

do

die

dorm

dor

do



Tell It!

Who did you tell?

Go tell someone the word!

Sight Word Work

Name: _____

Date: _____

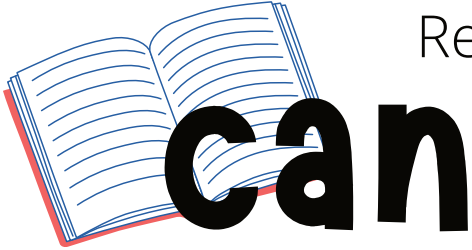

Read It!

Say the word out loud.

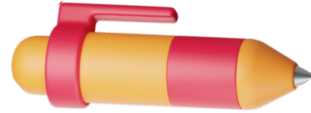

Write It!

Write the word.



Clap It!

How many syllables are in the word?
Color in the correct number.

can

Color It!

Color in the word.



Trace It!

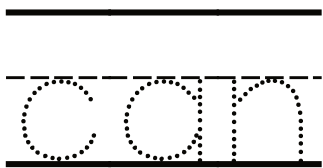

Trace the word.

Spell It!

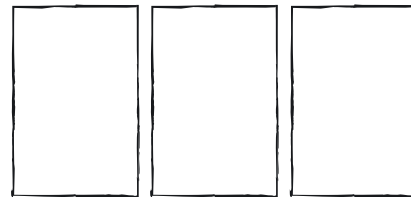

Spell the word.



Find It!

Find the word and color it in.

can

call

can

cool

cap

can



Tell It!

Who did you tell?

Go tell someone the word!

Sight Word Work

Name: _____

Date: _____



Read It!

Say the word out loud.

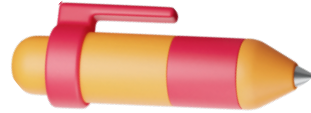

Write It!

Write the word.



Clap It!

How many syllables are in the word?
Color in the correct number.



Color It!

Color in the word.



Trace It!

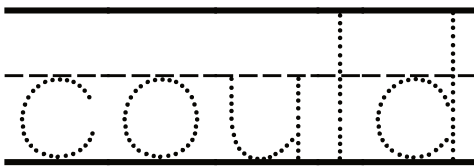

Trace the word.

Spell It!



Spell the word.



Find It!

Find the word and color it in.

could

then

could

cabin

could

caber



Tell It!

Who did you tell?

Go tell someone the word!

Sight Word Work

Name: _____

Date: _____

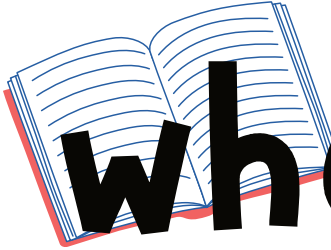

Read It!

when

Say the word out loud.

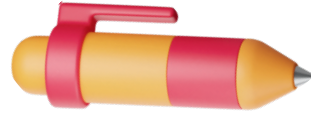

Write It!

Write the word.



Clap It!

How many syllables are in the word?
Color in the correct number.

when

Color It!

Color in the word.



Trace It!

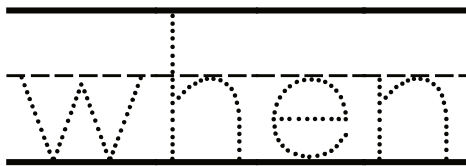

Trace the word.

Spell It!

--	--	--	--

Spell the word.



Find It!

Find the word and color it in.

when	when	Warm
Wolf	when	Who



Tell It!

Who did you tell?

Go tell someone the word!

Sight Word Work

Name: _____

Date: _____

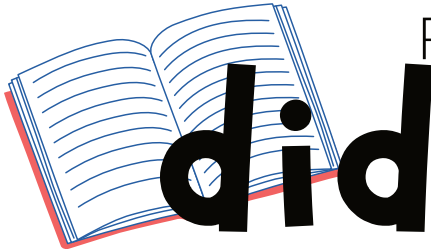

Read It!

Say the word out loud.

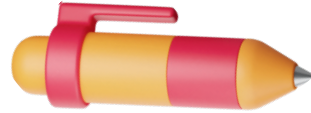

Write It!

Write the word.



Clap It!

How many syllables are in the word?
Color in the correct number.

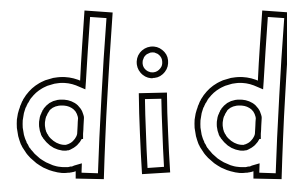

Color It!

Color in the word.



Trace It!

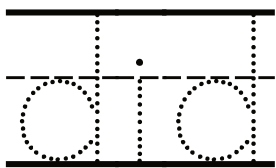

Trace the word.

Spell It!



Spell the word.



Find It!

Find the word and color it in.

dad

did

Warm

did

dam

dad



Tell It!

Who did you tell?

Go tell someone the word!

Sight Word Work

Name: _____

Date: _____

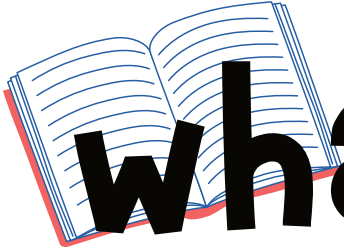

Read It!

what

Say the word out loud.

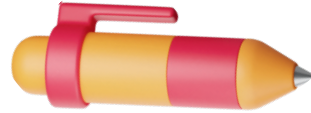

Write It!

Write the word.



Clap It!

How many syllables are in the word?
Color in the correct number.

Color It!

what

Color in the word.



Trace It!

what

Trace the word.

Spell It!

--	--	--	--

Spell the word.



Find It!

Find the word and color it in.

what	Wolf	what
what	Water	Who



Tell It!

Who did you tell?

Go tell someone the word!

Sight Word Work

Name: _____

Date: _____

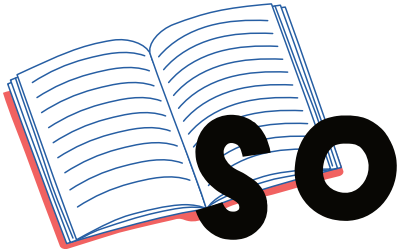

Read It!

Say the word out loud.

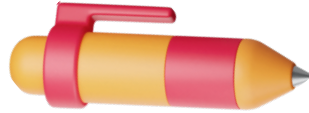

Write It!

Write the word.



Clap It!

How many syllables are in the word?
Color in the correct number.



Color It!

Color in the word.



Trace It!



Trace the word.

Spell It!

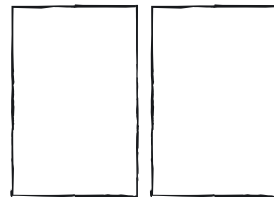

Spell the word.



Find It!

Find the word and color it in.

so	os	so
si	so	as



Tell It!

Who did you tell?

Go tell someone the word!

Sight Word Work

Name: _____

Date: _____

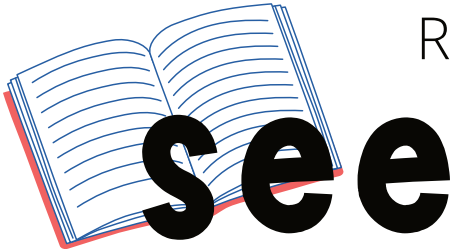

Read It!

see

Say the word out loud.

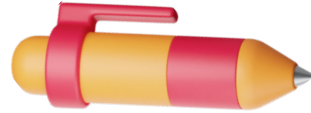

Write It!

Write the word.



Clap It!

How many syllables are in the word?
Color in the correct number.



Color It!

Color in the word.



Trace It!



Trace the word.

Spell It!

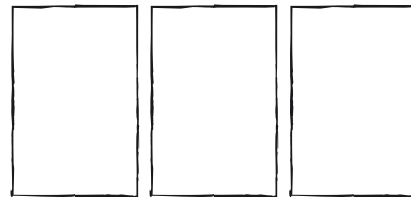

Spell the word.



Find It!

Find the word and color it in.

sod

see

sos

see

sew

see



Tell It!

Who did you tell?

Go tell someone the word!

Sight Word Work

Name: _____

Date: _____

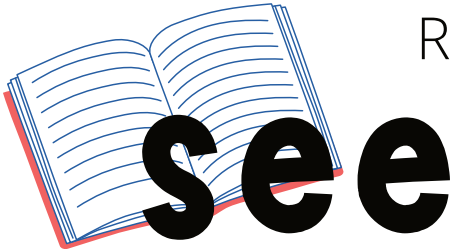

Read It!

Say the word out loud.

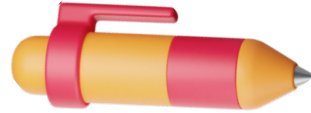

Write It!

Write the word.



Clap It!

How many syllables are in the word?
Color in the correct number.



Color It!

Color in the word.



Trace It!



Trace the word.

Spell It!

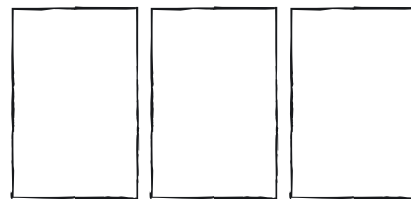

Spell the word.



Find It!

Find the word and color it in.

sod

see

sos

see

sew

see



Tell It!

Who did you tell?

Go tell someone the word!

Sight Word Work

Name: _____

Date: _____

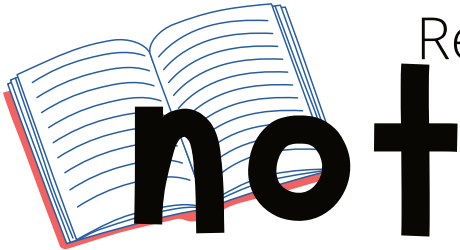

Read It!

not

Say the word out loud.

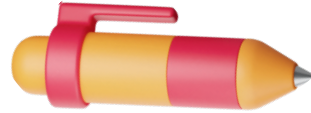

Write It!

Write the word.



Clap It!

How many syllables are in the word?
Color in the correct number.



Color It!

Color in the word.



Trace It!

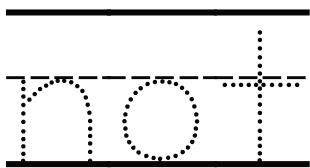

Trace the word.

Spell It!

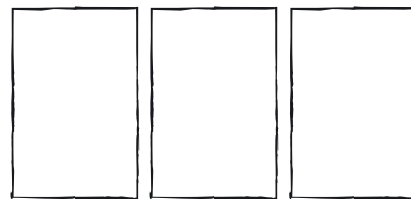

Spell the word.



Find It!

Find the word and color it in.

not

nab

not

not

nay

nae



Tell It!

Who did you tell?



Go tell someone the word!

Sight Word Work

Name: _____

Date: _____

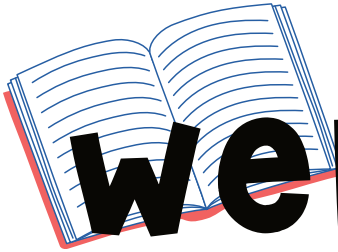

Read It!

were

Say the word out loud.

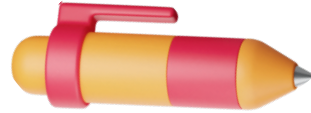

Write It!

Write the word.



Clap It!

How many syllables are in the word?
Color in the correct number.

were

Color It!

Color in the word.



Trace It!

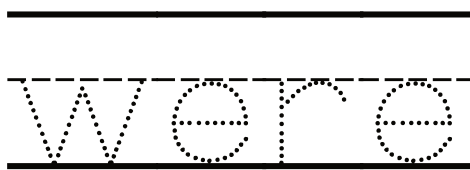

Trace the word.

Spell It!

--	--	--	--

Spell the word.



Find It!

Find the word and color it in.

were	were	war
wag	wap	were



Tell It!

Who did you tell?

Go tell someone the word!

Sight Word Work

Name: _____

Date: _____

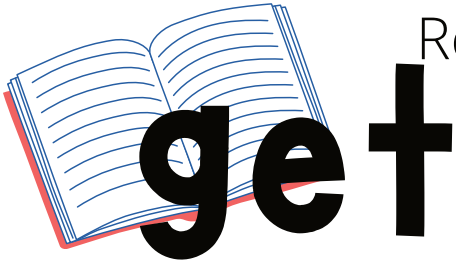

Read It!

get

Say the word out loud.

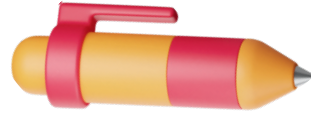

Write It!

Write the word.



Clap It!

How many syllables are in the word?
Color in the correct number.



Color It!

Color in the word.



Trace It!

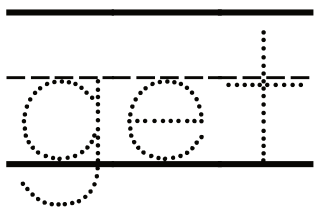

Trace the word.

Spell It!

--	--	--

Spell the word.



Find It!

Find the word and color it in.

gad	get	gap
get	gam	get



Tell It!

Who did you tell?

Go tell someone the word!

Sight Word Work

Name: _____

Date: _____

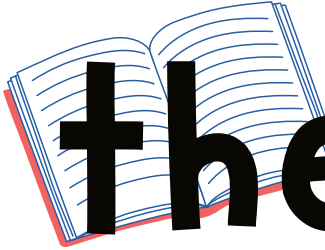

them

Read It!

Say the word out loud.

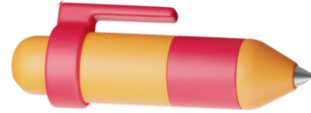

Write It!

Write the word.



Clap It!

How many syllables are in the word?
Color in the correct number.

them

Color It!

Color in the word.



Trace It!

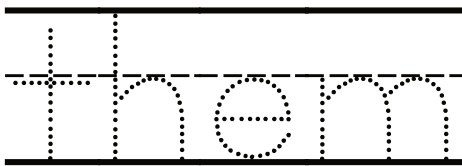

Trace the word.

Spell It!

--	--	--	--

Spell the word.



Find It!

Find the word and color it in.

trip	them	turn
them	toss	them



Tell It!

Who did you tell?

Go tell someone the word!

Sight Word Work

Name: _____

Date: _____



Read It!

Say the word out loud.

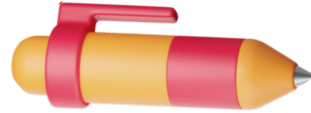

Write It!

Write the word.



Clap It!

How many syllables are in the word?
Color in the correct number.



Color It!

Color in the word.



Trace It!

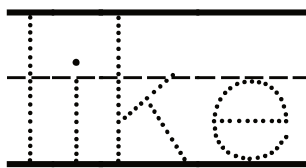

Trace the word.

Spell It!

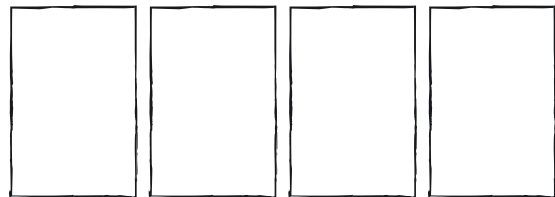

Spell the word.



Find It!

Find the word and color it in.

like

Lock

Lark

Lily

like

like



Tell It!

Who did you tell?

Go tell someone the word!

Sight Word Work

Name: _____

Date: _____



Read It!

Say the word out loud.

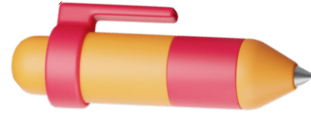

Write It!

Write the word.



Clap It!

How many syllables are in the word?
Color in the correct number.

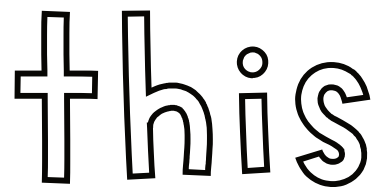

Color It!

Color in the word.



Trace It!

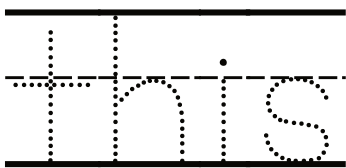

Trace the word.

Spell It!

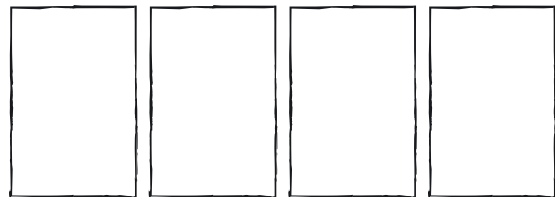

Spell the word.



Find It!

Find the word and color it in.

trap

this

this

this

tilt

tend



Tell It!

Who did you tell?

Go tell someone the word!

Sight Word Work

Name: _____

Date: _____



Read It!

Say the word out loud.

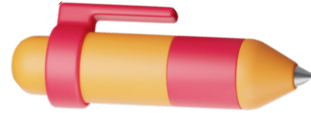

Write It!

Write the word.



Clap It!

How many syllables are in the word?
Color in the correct number.

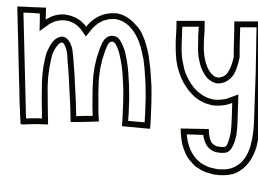

Color It!

Color in the word.



Trace It!

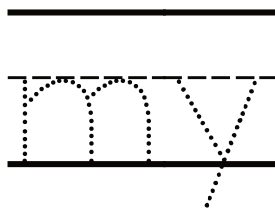

Trace the word.

Spell It!

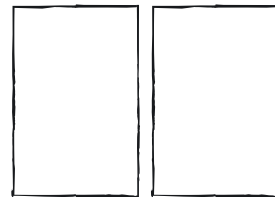

Spell the word.



Find It!

Find the word and color it in.

my

me

my

mi

mo

my



Tell It!

Who did you tell?

Go tell someone the word!

Sight Word Work

Name: _____

Date: _____

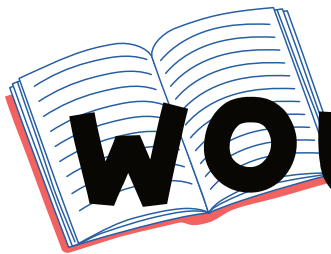

Read It!

would

Say the word out loud.

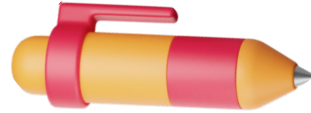

Write It!

Write the word.



Clap It!

How many syllables are in the word?
Color in the correct number.

Color It!

would

Color in the word.



Trace It!

would

Trace the word.

Spell It!

--	--	--	--	--

Spell the word.



Find It!

Find the word and color it in.

would

wacky

would

wages

would

waits



Tell It!

Who did you tell?

Go tell someone the word!

Sight Word Work

Name: _____

Date: _____

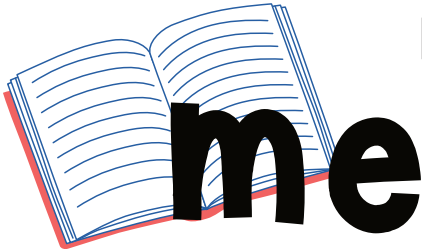

Read It!

Say the word out loud.

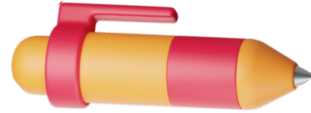

Write It!

Write the word.



Clap It!

How many syllables are in the word?
Color in the correct number.

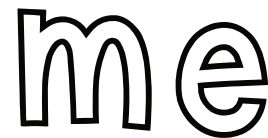

Color It!

Color in the word.



Trace It!

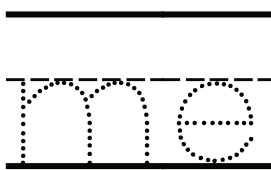

Trace the word.

Spell It!

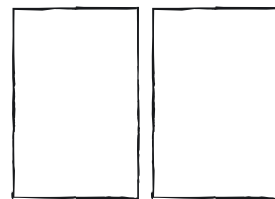

Spell the word.



Find It!

Find the word and color it in.

me

mo

me

mi

me

my



Tell It!

Who did you tell?

Go tell someone the word!

Sight Word Work

Name: _____

Date: _____

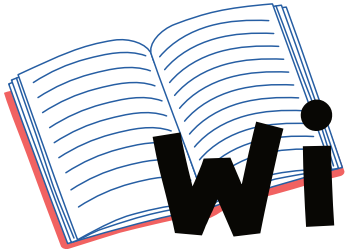

Read It!

will

Say the word out loud.

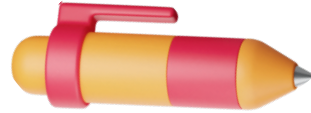

Write It!

Write the word.



Clap It!

How many syllables are in the word?
Color in the correct number.



Color It!

Color in the word.



Trace It!

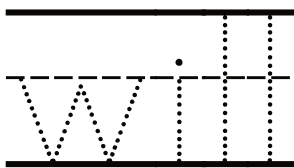

Trace the word.

Spell It!

--	--	--	--

Spell the word.



Find It!

Find the word and color it in.

was	will	war
will	wai	will



Tell It!

Who did you tell?

Go tell someone the word!

Sight Word Work

Name: _____

Date: _____

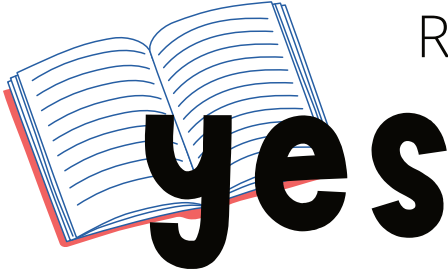

Read It!

yes

Say the word out loud.

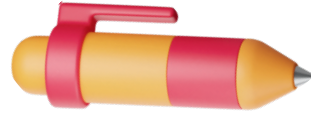

Write It!

Write the word.



Clap It!

How many syllables are in the word?
Color in the correct number.

Color It!

yes

Color in the word.



Trace It!

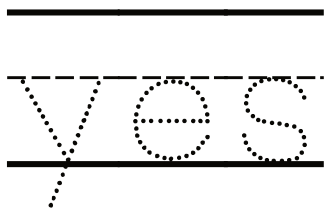

Trace the word.

Spell It!

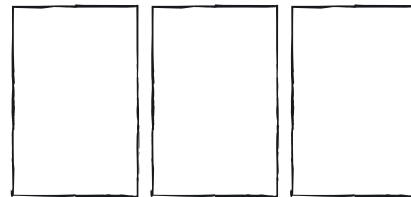

Spell the word.



Find It!

Find the word and color it in.

yes	yad	yet
yaa	yes	yes



Tell It!

Who did you tell?



Go tell someone the word!

Sight Word Work

Name: _____

Date: _____

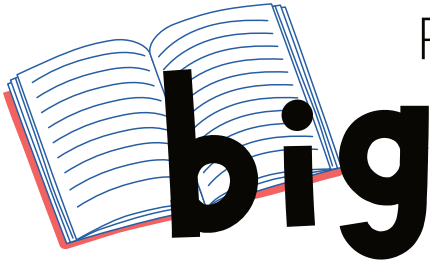

Read It!

Say the word out loud.

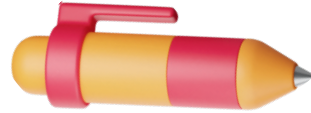

Write It!

Write the word.



Clap It!

How many syllables are in the word?
Color in the correct number.

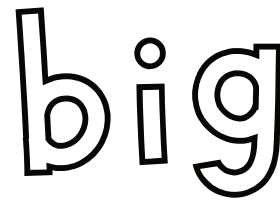

Color It!

Color in the word.



Trace It!

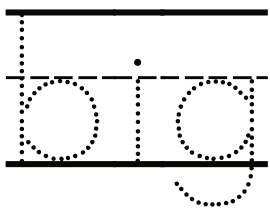

Trace the word.

Spell It!

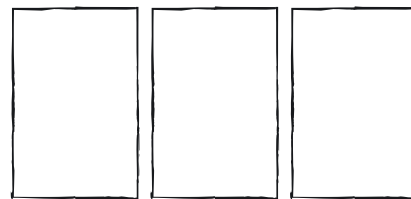

Spell the word.



Find It!

Find the word and color it in.

big

bad

big

big

bam

bag



Tell It!

Who did you tell?

Go tell someone the word!

Sight Word Work

Name: _____

Date: _____

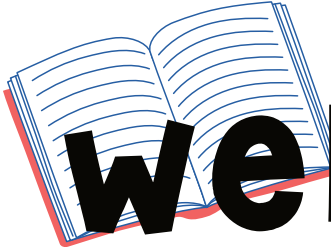

Read It!

went

Say the word out loud.

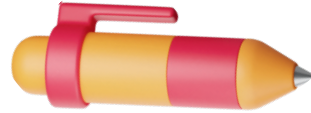

Write It!

Write the word.



Clap It!

How many syllables are in the word?
Color in the correct number.

Color It!

went

Color in the word.



Trace It!

went

Trace the word.

Spell It!

Spell the word.



Find It!

Find the word and color it in.

went

wale

went

walk

went

wait



Tell It!

Who did you tell?

Go tell someone the word!

Sight Word Work

Name: _____

Date: _____

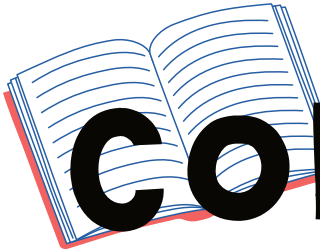

Read It!

come

Say the word out loud.

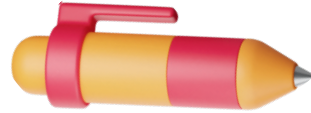

Write It!

Write the word.



Clap It!

How many syllables are in the word?
Color in the correct number.

Color It!

come

Color in the word.



Trace It!

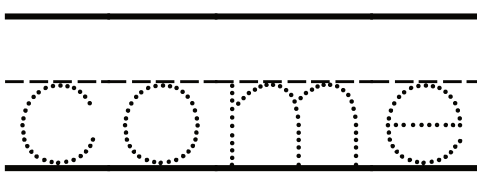

Trace the word.

Spell It!

--	--	--	--

Spell the word.



Find It!

Find the word and color it in.

clay	come	come
come	cake	crow



Tell It!

Who did you tell?

Go tell someone the word!

Sight Word Work

Name: _____

Date: _____

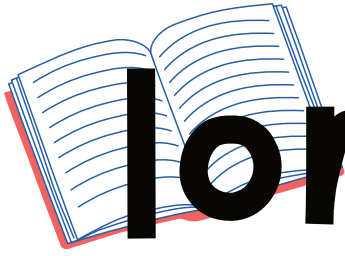

Read It!

long

Say the word out loud.

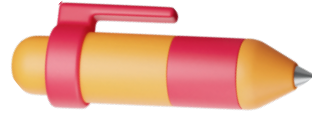

Write It!

Write the word.



Clap It!

How many syllables are in the word?
Color in the correct number.

Color It!

long

Color in the word.



Trace It!

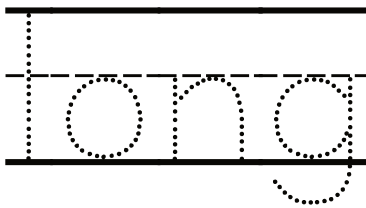

Trace the word.

Spell It!

--	--	--	--

Spell the word.



Find It!

Find the word and color it in.

long	List	long
Love	long	Lone



Tell It!

Who did you tell?

Go tell someone the word!

Sight Word Work

Name: _____

Date: _____

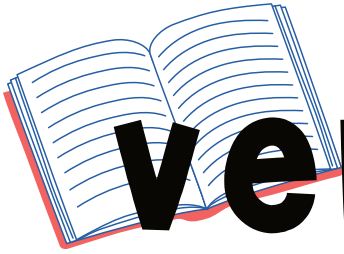

Read It!

very

Say the word out loud.

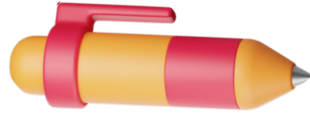

Write It!

Write the word.



Clap It!

How many syllables are in the word?
Color in the correct number.

Color It!

very

Color in the word.



Trace It!

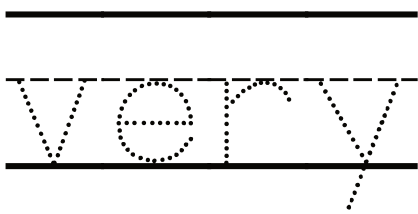

Trace the word.

Spell It!

--	--	--	--

Spell the word.



Find It!

Find the word and color it in.

vain	very	vac
very	vale	very



Tell It!

Who did you tell?

Go tell someone the word!

Sight Word Work

Name: _____

Date: _____

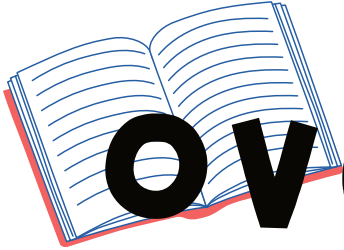

Read It!

over

Say the word out loud.

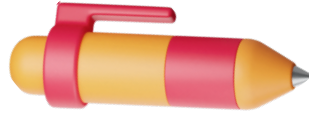

Write It!

Write the word.



Clap It!

How many syllables are in the word?
Color in the correct number.

over

Color It!

Color in the word.



Trace It!

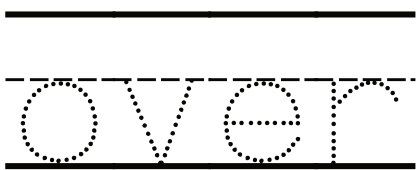

Trace the word.

Spell It!

--	--	--	--

Spell the word.



Find It!

Find the word and color it in.

over	obey	over
omit	over	opal



Tell It!

Who did you tell?

Go tell someone the word!

Sight Word Work

Name: _____

Date: _____

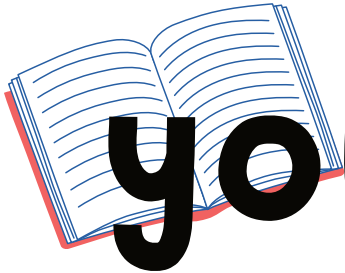

Read It!

your

Say the word out loud.

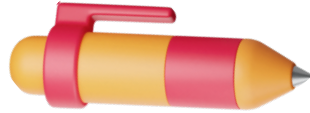

Write It!

Write the word.



Clap It!

How many syllables are in the word?
Color in the correct number.

Color It!

your

Color in the word.



Trace It!

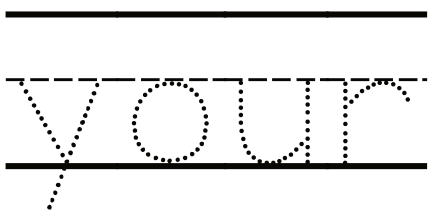

Trace the word.

Spell It!

--	--	--	--

Spell the word.



Find It!

Find the word and color it in.

your	yolk	yawp
yang	your	your



Tell It!

Who did you tell?

Go tell someone the word!

Sight Word Work

Name: _____

Date: _____

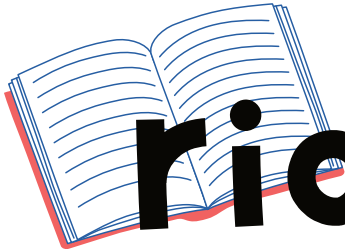

Read It!

ride

Say the word out loud.

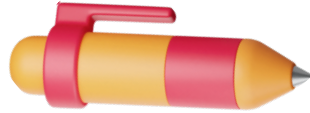

Write It!

Write the word.



Clap It!

How many syllables are in the word?
Color in the correct number.

Color It!

ride

Color in the word.



Trace It!

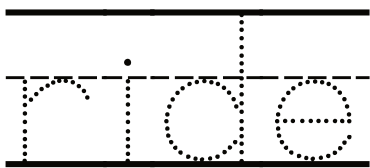

Trace the word.

Spell It!

--	--	--	--

Spell the word.



Find It!

Find the word and color it in.

ride	Race	ride
ride	Rage	Racy



Tell It!

Who did you tell?

Go tell someone the word!

Sight Word Work

Name: _____

Date: _____



Read It!

Say the word out loud.

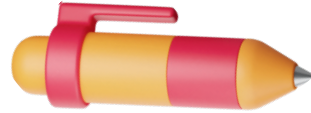

Write It!

Write the word.



Clap It!

How many syllables are in the word?
Color in the correct number.

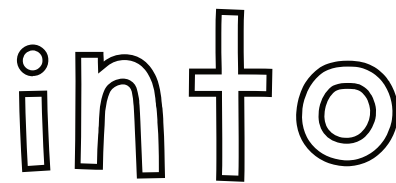

Color It!

Color in the word.



Trace It!

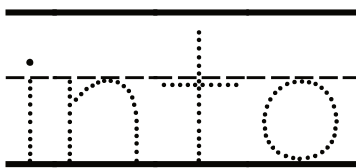

Trace the word.

Spell It!

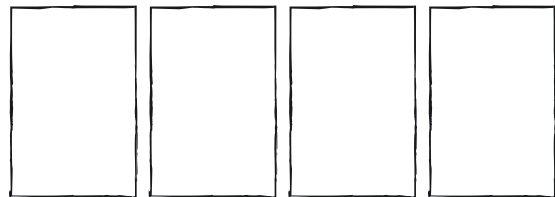

Spell the word.



Find It!

Find the word and color it in.

irky

into

icon

into

info

into



Tell It!

Who did you tell?

Go tell someone the word!

Sight Word Work

Name: _____

Date: _____

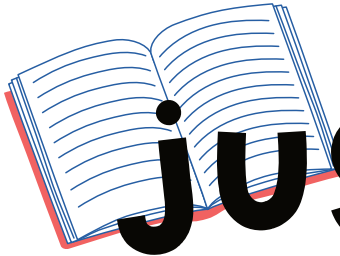

Read It!

just

Say the word out loud.

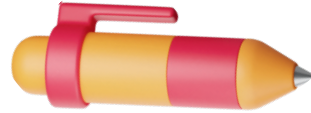

Write It!

Write the word.



Clap It!

How many syllables are in the word?
Color in the correct number.

Color It!

just

Color in the word.



Trace It!

just

Trace the word.

Spell It!

--	--	--	--

Spell the word.



Find It!

Find the word and color it in.

July	just	jabs
just	Jack	just



Tell It!

Who did you tell?

Go tell someone the word!



Writing practice

Name: _____

Date: _____

Handwriting practice lines consisting of 15 sets of horizontal lines. Each set includes a solid top line, a dashed red middle line, and a solid bottom line.



Writing practice

Name: _____

Date: _____

Handwriting practice lines consisting of 18 rows. Each row is defined by a solid top line, a dashed red middle line, and a solid bottom line.



Writing practice

Name: _____

Date: _____

Handwriting practice lines consisting of 15 sets of horizontal lines. Each set includes a solid top line, a dashed red middle line, and a solid bottom line.



Writing practice

Name: _____

Date: _____

Handwriting practice lines consisting of 15 sets of horizontal lines. Each set includes a solid top line, a dashed red middle line, and a solid bottom line.

THANK
YOU

