

2017-18

Class 12



# CHEMISTRY

## FOR JEE MAIN & ADVANCED

SECOND  
EDITION



Topic Covered  
Aldehydes and Ketones

Exhaustive Theory ◀  
(Now Revised)

Formula Sheet ◀

9000+ Problems ◀  
based on latest JEE pattern

2500 + 1000 (New) Problems ◀  
of previous 35 years of  
AIEEE (JEE Main) and IIT-JEE (JEE Adv)

5000+ Illustrations and Solved Examples ◀

Detailed Solutions ◀  
of all problems available

Planceess Concepts

Tips & Tricks, Facts, Notes, Misconceptions,  
Key Take Aways, Problem Solving Tactics

Planceessential

Questions recommended for revision

  
WHERE PLAN MEETS SUCCESS

# 23. ALDEHYDES AND KETONES

## CARBONYL COMPOUNDS

### 1. INTRODUCTION

Carbonyl compounds have a general formula  $C_nH_{2n}O$  and contain a  $>C=O$  group which is present in aldehydes  $\left[ \begin{array}{l} \diagup \\ H \end{array} \right] C=O$  as well as in  $\left[ \begin{array}{l} R \\ \diagdown \\ R \end{array} \right] C=O$  ketones. They are constituents of fabrics, plastics and drugs. These are also used as reagents and solvents.

### 1.1 Structure of Carbonyl Compounds

In carbonyl group both the carbon and oxygen atoms are in  $sp^2$  hybridised state. One of the  $sp^2$  hybrid orbital of one carbon atom overlaps with one of the  $sp^2$  hybrid orbital of oxygen atom forming C–O  $\sigma$ -bond. The remaining two  $sp^2$  hybrid orbitals of C atom overlap with either  $sp^3$  orbital of C-atoms (as in ketone) or one with  $sp^3$  orbital carbon and other with s orbital of hydrogen (as in aldehyde forming) 2 more  $\sigma$ -bonds. On the other hand each of two  $sp^3$  hybrid orbitals of 'oxygen' atom contains a lone pair of electrons. Unhybrid orbitals present at the carbon and oxygen atom form  $\pi$ - bond by sideways overlapping. The structure can be represented as:

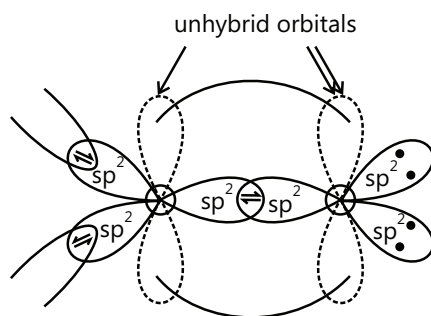
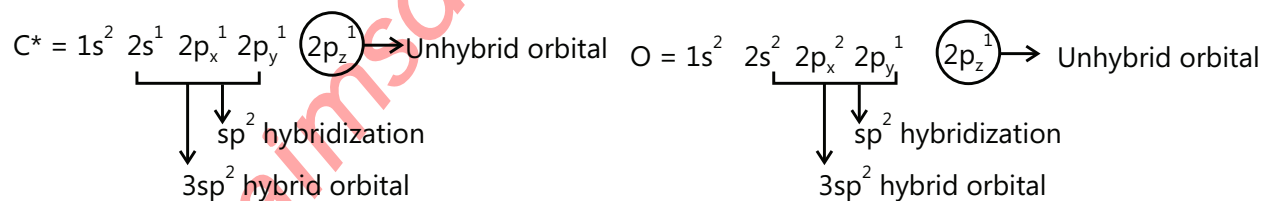


Figure 23.1: Structure of carbonyl compounds

Thus C = O group contains one  $\sigma$ -bond and one  $\pi$ -bond as  $\begin{array}{c} \diagup \\ \text{C} \\ \diagdown \\ \text{H} \end{array} \begin{array}{c} \pi \\ \sigma \\ \text{O} \end{array} \text{:}$

## 1.2 Bonding in Aldehydes and Ketones

The carbonyl carbon atom is  $sp^2$  hybridized. The unhybridized p-orbital form a  $\pi$ -bond with a p-orbital of oxygen. The double bond between carbons and oxygen is shorter, stronger and polarized.

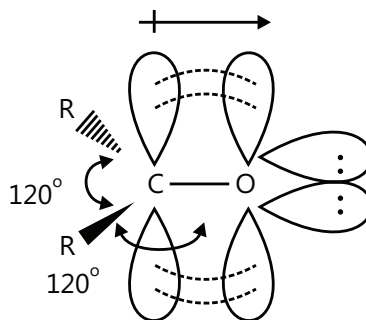
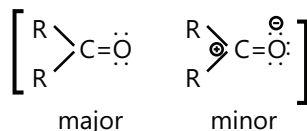


Figure 23.2: Bonding of carbonyl compounds

	Length Energy	
Ketone C = O bond	1.23 Å	178 kcal /mol (745 kJ/mol)
Alkene C = C bond	1.34 Å	146 kcal/mol (611 kJ / mol)

The double bond of the carbonyl group has a large dipole moment because oxygen is more electronegative than carbon.



## 1.3 Comparison of C=O Bond with C=C Bond

- (a) Both atoms in both the cases are in the  $sp^2$  hybridised state.  
 (b) Both the cases contain one  $\sigma$ -bond and one  $\pi$ -bond.

The difference between C=O and C=C is because of O-atom in carbonyl group is more electronegative than carbon

as a result polarity is developed as  $\rightarrow \begin{array}{c} \delta^+ \\ \text{C} \\ \delta^- \\ \text{O} \end{array}$

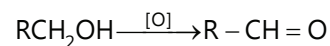
Thus, the double bond of the carbonyl group has a large dipole moment. This polarity conforms that there is nucleophilic addition reaction in the carbonyl compound on other hand in alkene (C = C) there is electrophilic addition reaction

## 2. METHOD OF PREPARATION OF ALDEHYDES AND KETONES

### 2.1 From Alcohols

#### 2.1.1 By Oxidation of Alcohols

1° Alcohol on oxidation using PCC gives an aldehyde. 2° alcohol gives a ketone on oxidation by  $\text{Na}_2\text{Cr}_2\text{O}_7$



## PLANCESS CONCEPTS

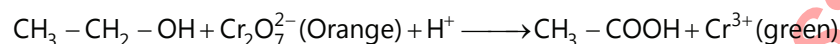
- If acidified  $K_2Cr_2O_7$  or  $KMnO_4$  is used then aldehyde further oxidise to give acid.
- PCC (Pyridinium chloro-chromate in  $CH_2Cl_2$ ) and Collin's reagent ( $CrO_3$  Pyridine) are used to get aldehyde from  $1^\circ$  alcohol. These reagents do not attack at double bond.

Saurabh Gupta (JEE 2010, AIR 443)

**Illustration 1:** In the following reaction when we mix Dichromate with Ethanol, the colour of the solution changes from orange to green. Give reason.  $CH_3 - CH_2 - OH + Cr_2O_7^{2-} + H^+$  (JEE ADVANCED)

**Sol:** Dichromate is an oxidizing agent and during the reaction itself undergoes the reduction process and the green colour is due to the formation of reduced chromate  $Cr^{3+}$

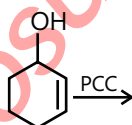
Dichromate is a good oxidizing agent, it oxidizes the primary alcohol to Acid and itself gets reduced to Chromium ion ( $Cr^{3+}$ ). The colour of dichromate is Orange and that of Chromium is green. This is shown by the following equation:



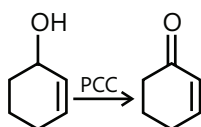
Thus this method is not useful in preparation of aldehydes and ketones.

**Illustration 2:** Complete the following reaction:

(JEE MAIN)

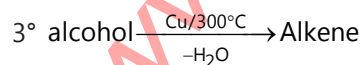
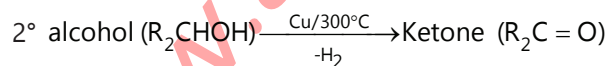
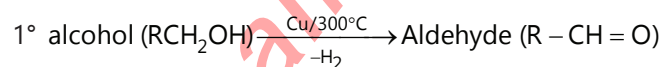


**Sol:** As the alcohol is a  $2^\circ$  alcohol, and PCC is a mild oxidizing agent. So, we get a ketone as a product.



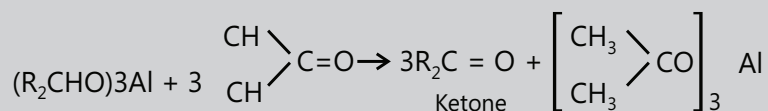
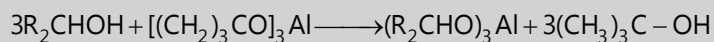
## 2.1.2 By Dehydrogenation of Alcohols

Dehydrogenation means removal of hydrogen and the reagent used is heated copper.



### PLANCESS CONCEPTS

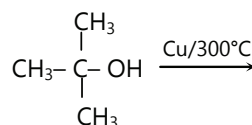
2° alcohol can also be oxidised to ketone by aluminium t-butoxide. During the reaction, 2° alcohol is first refluxed with reagent  $[(\text{CH}_3)_2\text{CO}]_3\text{Al}$ , followed by acetone.



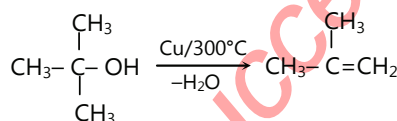
Neeraj Toshniwal (JEE 2009, AIR 21)

**Illustration 3:** Complete the following reaction.

(JEE MAIN)



**Sol:** It is an example of dehydrogenation of alcohols. The product formed will be an alkene.



### PLANCESS CONCEPTS

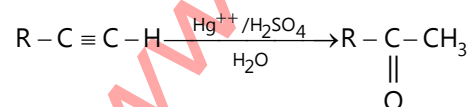
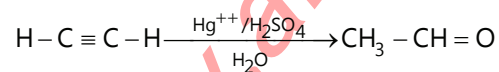
As the reaction proceeds at high temperature, so a thermodynamically stable product would be favored in this case.

Aman Gour (JEE 2012, AIR 230)

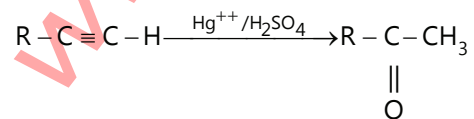
## 2.2 From Hydrocarbons

### 2.2.1 Hydration of Alkynes

It is the addition of water in the presence of a heavy metal ion. Acetylene on hydration gives aldehyde while any higher alkyne gives ketone.



For example, In the case shown below, by varying the Alkyl (-R) group, the product also varies accordingly.



(A)

(B)

R	A	B
H	H-C≡C-H	$\begin{array}{c} \text{O}=\text{C}-\text{CH}_3 \\   \\ \text{H} \end{array}$
CH <sub>3</sub>	$\text{CH}_3-\overset{\curvearrowright}{\text{C}}\equiv\text{C}-\text{H}$	$\begin{array}{c} \text{CH}_3-\text{C}-\text{CH}_3 \\    \\ \text{O} \end{array}$
Cl-CH <sub>2</sub> -	$\text{Cl}-\text{CH}_2-\overset{\curvearrowright}{\text{C}}\equiv\text{C}-\text{H}$	$\text{Cl}-\text{CH}_2-\text{CH}_2-\text{CH}=\text{O}$

In the above reaction, the carbonyl group will be formed on that carbon of the alkyne which is easy to attack by the nucleophile (water in this case). Thus, a less crowded carbon will favour the formation of a carbonyl group whereas a more crowded carbon will not favour it. . Therefore, in case (iii), the carbonyl group is formed on that carbon which is easy to attack

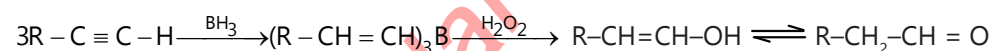
### PLANCESS CONCEPTS

- The preparation of carbonyl compounds from the alkyne depends upon the R part and also presence of inductive effect of the group attached to R.
- Carbonyl group will be at the C-atom at which H<sub>2</sub>O will attack as a nucleophile

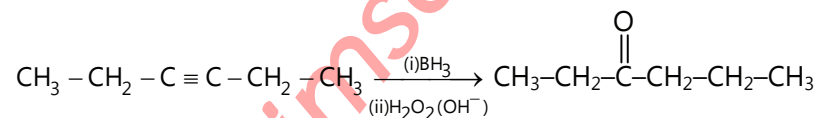
**B Rajiv Reddy (JEE 2012, AIR 11)**

### 2.2.2 Hydroboration of Alkyne

Hydroboration is a process used to get an aldehyde from a terminal alkyne. Here reagents are (i) diborane (B<sub>2</sub>H<sub>6</sub>) (ii) H<sub>2</sub>O<sub>2</sub>(OH<sup>-</sup>)

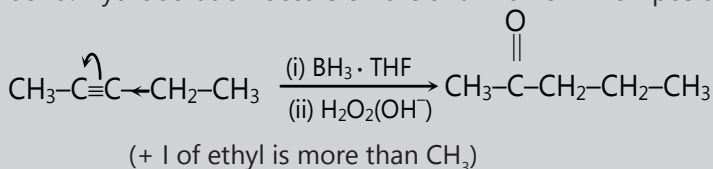


A higher alkyne except a terminal alkyne will give a ketone during hydroboration.



### PLANCESS CONCEPTS

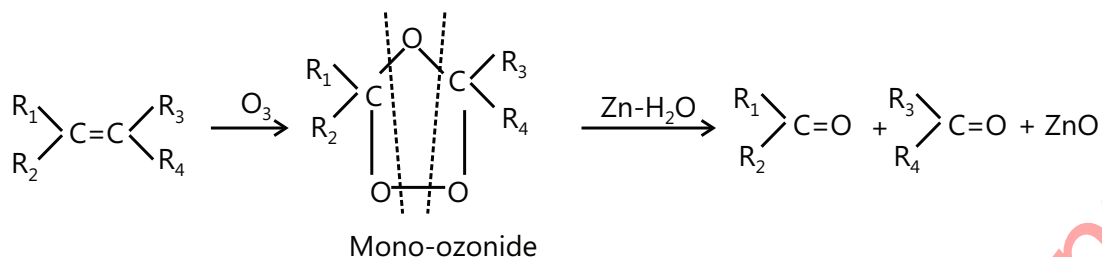
For an unsymmetrical alkyne ketone will be corresponding to that carbon atom over which electrophile BH<sub>3</sub> will attack. It depends upon the inductive effect and finally the polarization of π-electrons of C=C bond. Hydroboration occurs on the anti-Markownikoff position.



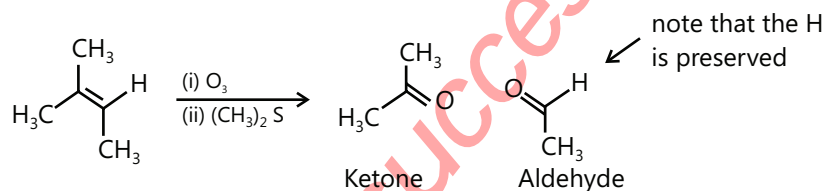
**Rohit Kumar JEE 2012, AIR 79**

### 2.2.3 Ozonolysis of Alkenes

Ozonolysis is used to get carbonyl compounds from alkenes. The reaction is -

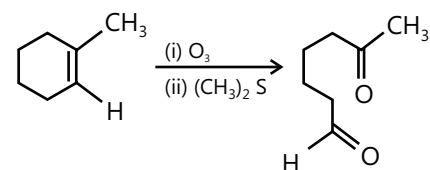


**Note:** That the carbon-carbon double bond is broken and we are forming a carbon-oxygen double bond on each of the two carbons that originally composed the alkene. The second step in ozonolysis is called the "workup". There are two different types of "workup", and the most common is referred to as the "reductive workup". In this step, we add a reducing agent (commonly zinc metal or dimethyl sulfide) that decomposes the intermediate formed at the end of the ozonolysis reaction (which is called an "ozonide"). The third oxygen of ozone is now attached to what used to be our reducing agent (which may be either zinc oxide (ZnO) or dimethyl sulfoxide (DMSO)). Using a "reductive workup" preserves all other aspects of the molecule save the double bond. So if we start with, say, a trisubstituted alkene, as in the example, we will end up with a ketone and an aldehyde. [What happens if the alkene carbon is attached to two hydrogens? It becomes formaldehyde, which is then further converted to carbon dioxide]



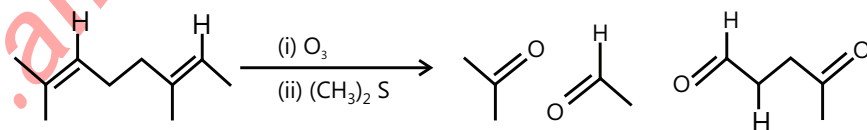
**"Reductive workup" merely cleaves the C=C bond and replaces with oxygen**

**Note:** That although  $(\text{CH}_3)_2\text{S}$  is written as the reductant here, it's essentially interchangeable with Zn for our purposes. An interesting consequence of ozonolysis is that if the alkene is within a ring, you end up with a chain containing two carbonyls: Cyclic alkenes become chains - If your molecule has multiple alkenes, then you will end up with more than two fragments. For many years, ozonolysis was used as a method for determining the structures of unknown molecules. By "stitching" together the fragments and analysing them, it is then possible to deduce what the original structure was.



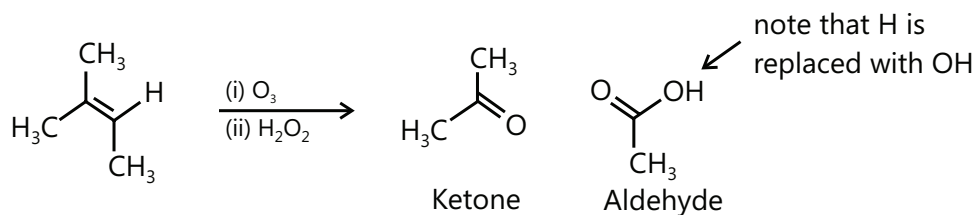
[This was particularly important in the case of unsaturated molecules known as terpenes]. Here's one example:

**Molecules with multiple alkenes are cleaved into fragments:**



This isn't the end of the story with ozonolysis. There's a second type of workup that can be used, which is referred to as oxidative workup. Instead of using Zn or S  $(\text{CH}_3)_2$ , if we use the oxidant hydrogen peroxide  $[\text{H}_2\text{O}_2]$ , any aldehydes that form will be oxidized to give carboxylic acids. Like in the example below - notice that the C-H bond is oxidized to C-OH [but all the other hydrogens remain intact].

"Oxidative workup" oxidized  $\text{sp}^2$  hybridized C-H bonds to C-OH as well as cleaving C = C



Typical oxidant used for "oxidative workup" is  $\text{H}_2\text{O}_2$ ; this oxidizes any aldehydes to carboxylic acids

### PLANCESS CONCEPTS

- This method is used because the double bond in olefin or exact structure of hydrocarbon can be determined by knowing ozonolysis product i.e. by placing double bond at the place of two carbonyl oxygen groups of two carbonyl compounds
- Among the molecules of carbonyl compounds produced:
- If there's a single molecule containing two carbonyl groups, then hydrocarbon will be alkadiene.
- If all the three molecules contain two carbonyl groups, then hydrocarbon will be cycloalkatriene.
- An alternative to using ozone for the oxidative workup is to use the reagent  $\text{KMnO}_4$ , especially in the presence of hot acid; this will lead to the same result.

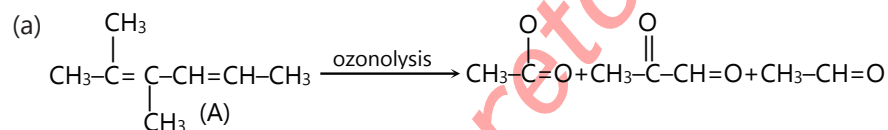
**Krishan Mittal (JEE 2012, AIR 199)**

**Illustration 4:** Which hydrocarbon on ozonolysis gives a mixture of acetone, acetaldehyde and methyl glyoxal?

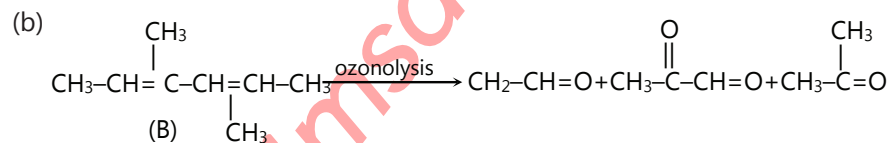
- (a) 2, 3-dimethylhexa-2-4-diene    (b) 2, 4-dimethylhex-2,4-diene

**(JEE ADVANCED)**

**Sol:**



2, 3-dimethylhexa-2-4-diene



2, 4-dimethylhex-2,4-diene

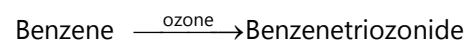
Answer will be both isomeric structures (A) and (B)

**Illustration 5:** Which hydrocarbon on ozonolysis gives 3 moles of glyoxal

**(JEE MAIN)**

**Sol:** As for formation of 3 moles of glyoxal we require a compound having six carbon atoms and three site of unsaturation so that ozonolysis can occur. so it appears to be an aromatic compound having six carbon backbone. i.e. Benzene

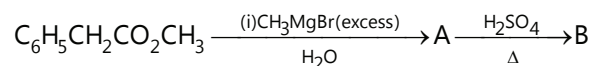
Benzene on ozonolysis gives 3 moles of glyoxal.





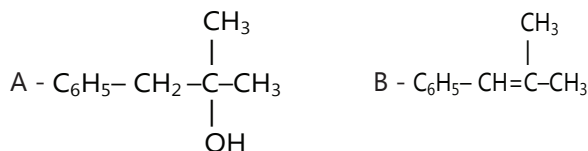


**Illustration 6:** Complete the following reaction:



(JEE MAIN)

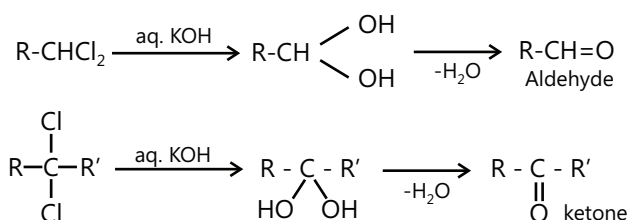
**Sol:** First step is attack of Grignard reagent to form an alcohol, as the starting compound is an ester we end up getting a tertiary alcohol which on treatment with Acid gives an alkene.



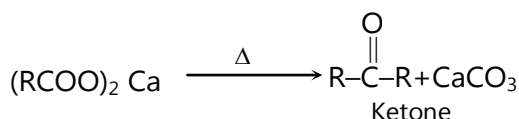
## 2.4 From Miscellaneous Groups

### 2.4.1 On Aqueous Alkali Hydrolysis of Gem Di-Halides

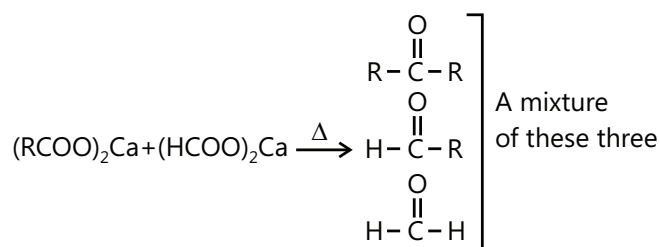
Terminal gem dihalides will give an aldehyde while a non-terminal will give ketones as follows



### 2.4.2 By Dry Distillation of Calcium Salts of Acid



On the dry distillation of calcium salt of acid with the calcium salt of formic acid we get a mixture of aldehyde, ketone and formaldehyde



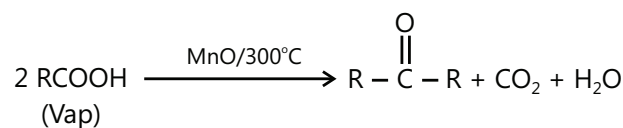
#### PLANCESS CONCEPTS

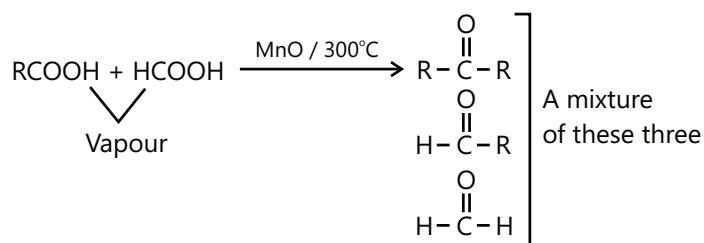
In this reaction, the yield is generally poor due to side reactions viz. formation of formaldehyde and acetone from calciumformate and calcium acetate respectively.

Aishwarya Karnawat (JEE 2012, AIR 839)

### 2.4.3 On Passing Vapours of Fatty Acids Over Manganous Oxide at 300°C

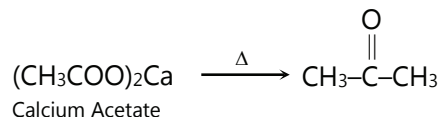
On passing the mixture of vapours of the fatty acid with formic acid we get a mixture of aldehyde, ketone and formaldehyde.





**Illustration 7:** Complete the following reaction:  $(\text{CH}_3\text{COO})_2\text{Ca} \xrightarrow{\Delta}$  (JEE MAIN)

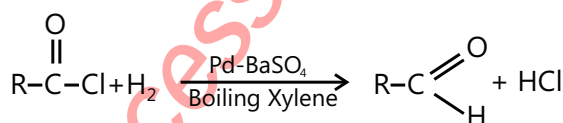
**Sol:** This method is commonly used for the preparation of a ketone.



## 2.5 Methods Used for the Preparation of Aldehydes Only

### 2.5.1 Rosenmund's Reaction

Here, acid chlorides are reduced to aldehyde with  $\text{H}_2$  in boiling xylene using palladium as a catalyst supported on barium sulphate.



#### PLANCESS CONCEPTS

- Pd catalyst is poisoned by  $\text{BaSO}_4$  to stop further reduction of aldehyde to alcohol.
- Formaldehyde ( $\text{HCHO}$ ) can't be obtained by this method because  $\text{HCOCl}$  is unstable at room temperature.
- On reacting acid chloride with dialkyl cadmium, we can obtain ketone.

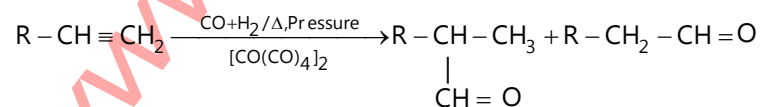
Saurabh Chatterjee (JEE Advanced 2013, AIR)

### 2.5.2 Stephen's Reduction



### 2.5.3 Oxo Process

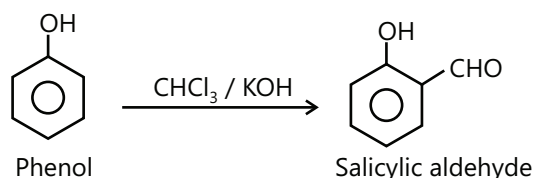
The Oxo process is also called carbonylation, here the alkene with water gas at high temperature and pressure in the presence of cobalt carbonyl catalyst to give aldehyde.



### 2.5.4 Reimer-Teimann Reaction

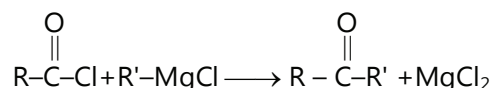
By this, a phenolic aldehyde is prepared

By this method phenolic aldehyde is prepared



## 2.6 Methods used for the Preparation of Ketones

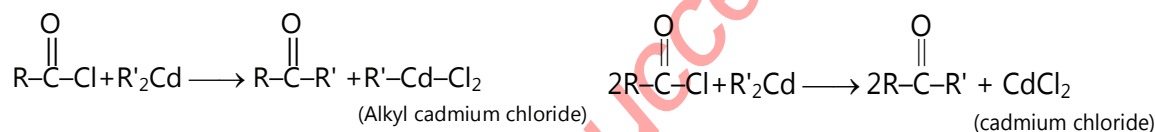
(a) Using alkanoyl chloride and Grignard reagent



(b) Using alkanoyl anhydride and Grignard reagent



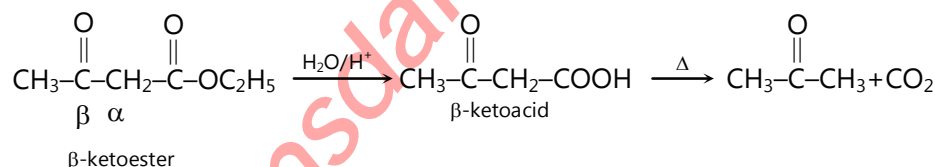
(c) Using alkanoyl chloride and dialkyl cadmium



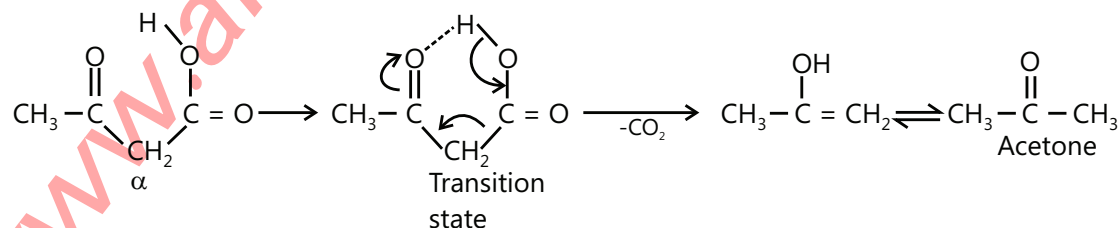
(d) By acylation or benzylation of aromatic hydrocarbon (Friedel-Craft Reaction)



(e) By acid hydrolysis followed by heating of  $\beta$ -Ketoester

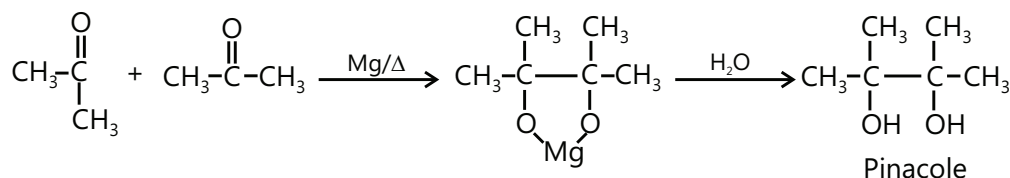


**Note:** It is  $\beta$ -ketoacid which decarboxylate more readily as it proceeds via six membered cyclic transition-state.

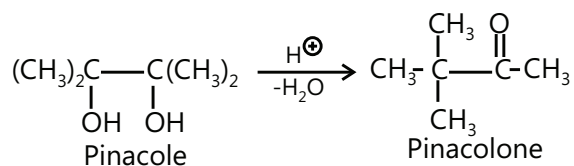


## 2.7 Pinacol – Pinacolone Rearrangement

Pinacole is obtained when 2 moles of acetone are heated with divalent active metal magnesium followed by treating with water

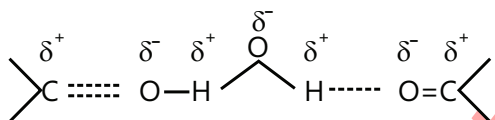


Pinacole undergoes rearrangement in acidic media to give pinacolone



### 3. PHYSICAL PROPERTIES OF CARBONYL COMPOUNDS

- (a) **Physical state:** Methanal is a pungent smelling gas. Ethanal is a volatile liquid, with a boiling point of 294 K. Other aldehydes and ketones containing up to 11 carbon atoms are colourless liquids while higher members are solids.
- (b) **Smell:** With the exception of lower aldehydes which have unpleasant odours, aldehydes and ketones generally have a pleasant smell. As the size of the molecule increases, the odour becomes less pungent and more fragrant. In fact, many naturally occurring aldehyde and ketones have been used in the blending of perfumed and flavourings agents.
- (c) **Solubility:** Aldehydes and ketones up to 4 C-atoms are miscible with water. This is due to the presence of hydrogen bonding between the polar carbonyl group and water molecules as shown below:

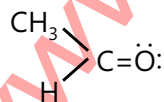


With the increase in the size of alkyl group, the solubility decreases. All aldehydes and ketones are, however, soluble in organic solvents such as ether, alcohol, etc. The ketones are good solvents themselves.

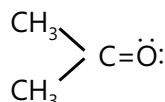
- (d) **Boiling points:** The boiling points of aldehydes and ketones are higher than those of non-polar compounds (hydrocarbons) or weakly polar compounds (such as ethers) of comparable molecular masses. However, their b.p.s' are lower than those of corresponding alcohols or carboxylic acids. This is because all aldehydes and ketones are polar compounds having sufficient intermolecular dipole-dipole interaction between the opposite ends of C = O dipoles.

However, these dipole-dipole interactions are weaker than the intermolecular hydrogen bonding in alcohols and carboxylic acids. Therefore, b.p.s' of aldehydes and ketones are relatively lower than the alcohols and carboxylic acids of comparable molecular masses.

Among the carbonyl compounds, ketones have a slightly higher boiling points than the isomeric aldehydes. This is due to the presence of two electron releasing groups around the carbonyl carbon, which makes them more polar.



Acetaldehyde  
( $\mu = 2.52$  D, bpt = 322 K)



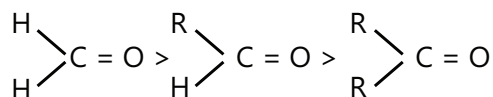
Acetone  
( $\mu = 2.88$  D, bpt = 329 K)

- (e) **Density:** Density of aldehydes and ketones is less than that of water

## 4. CHEMICAL REACTIONS OF CARBONYL COMPOUNDS

### 4.1 Nucleophilic Addition Reactions

Addition of a nucleophile and a proton across the (C = O) double bond. The reactivity of the carbonyl group arises from the electronegativity of the oxygen atom and the resulting polarization of the carbon-oxygen double bond. The electrophilic carbonyl carbon atom is  $sp^2$  hybridized and flat, leaving it relatively unhindered and open to attack from either face of the double bond.



**Illustration 8:** Why are aldehydes more reactive than ketones?

(JEE ADVANCED)

**Sol:** The factors which influence the reactivity of ketone and aldehyde are

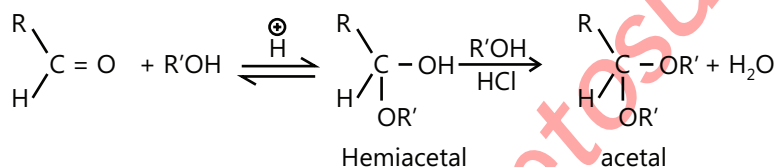
(i) Inductive effect (ii) Steric factor

(i) As alkyl group is electron releasing, + I effect of alkyl group decreases the amount of charge on  $C^+$  ( $C^+ - O^-$ ) in ketones.

(ii) Steric effect (crowding of bulky group) also causes the less reactivity of carbonyl group of ketone.

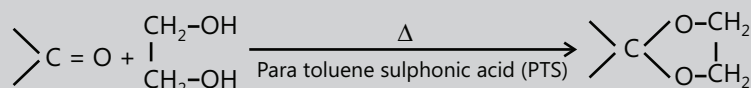
#### 4.1.1 Reaction with Alcohols

Carbonyl compounds react with alcohols in the presence of dry HCl gas to give acetal (if aldehyde) and ketal if ketone via formation of unstable hemiacetal and hemiketal respectively.

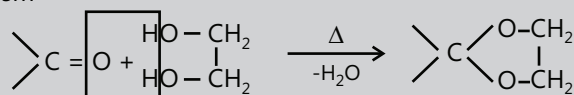


#### PLANCESS CONCEPTS

- Acetal is formed to protect aldehyde (as a functional group) and ketal to protect ketone for a long time. Acetal has a functional group 'Ether'.
- Acetal can be decomposed to original Aldehyde by dilute acids.
- On treating with ethylene glycol we get cyclic acetal or ketal (1, 3-dioxolane)



Mechanism

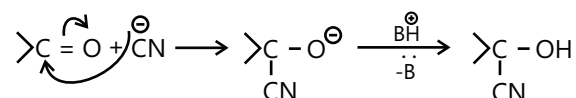
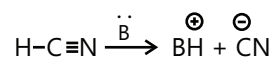
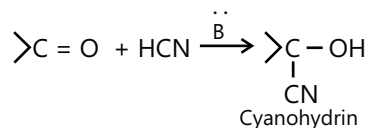


- Acetal formation is found to be more favourable than ketal formation if both the carbonyl groups are present within the molecule.

Mredul Sharda (JEE Advanced 2013, AIR)

### 4.1.2 Addition of HCN

It is a Base Catalyzed Addition



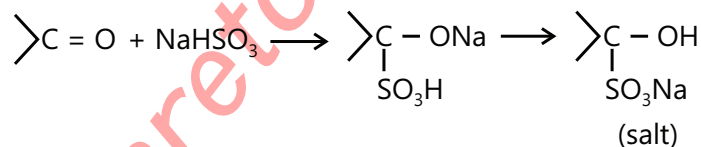
#### PLANCESS CONCEPTS

- Addition of HCN over aldehyde gives cyanohydrin and cyanohydrin on acid hydrolysis gives  $\alpha$ -hydroxy acid.
- Cyanohydrin on treating with  $\text{NH}_3$  (*l*) followed by acid hydrolysis gives  $\alpha$ -amino acid
- In case of ketone cyanohydrin formation is reversible due to bulky group of ketone which hinders the formation.

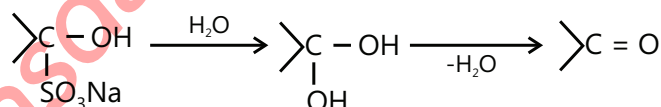
Vaibhav Krishnan (JEE 2009, AIR 22)

### 4.1.3 Addition of Sodium Bisulphite ( $\text{NaHSO}_3$ )

This addition is used to isolate carbonyl compounds from the mixture as we get a salt.



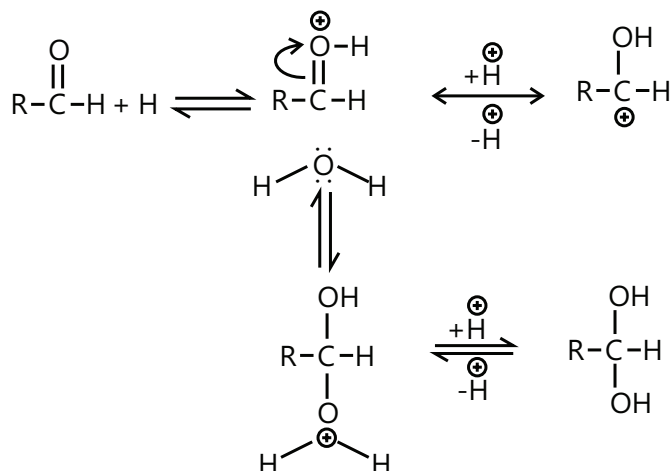
The salt on acidification gives carbonyl compounds again



### 4.1.4 Addition of Water

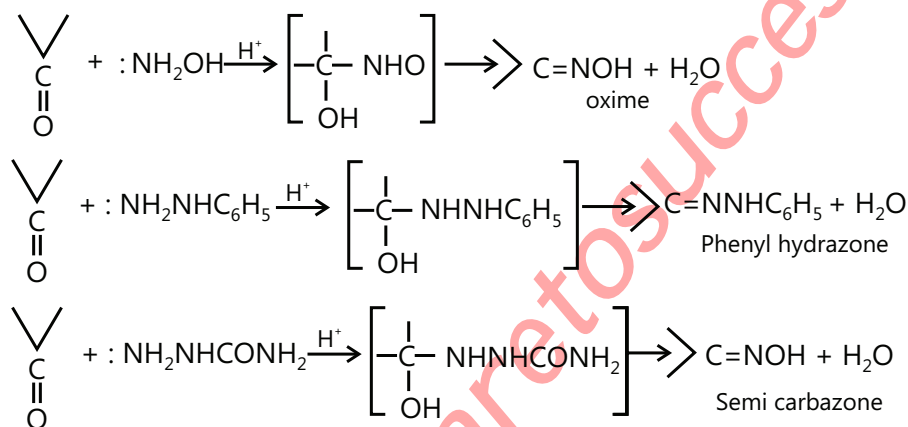
Aldehydes or ketones react with water to form gem-diols. Water is a poor nucleophile and therefore adds relatively slowly to the carbonyl group, but the rate of reaction can be increased by an acid catalyst. Reaction is reversible so removal of water gives back the corresponding carbonyl compound.

**Mechanism:**



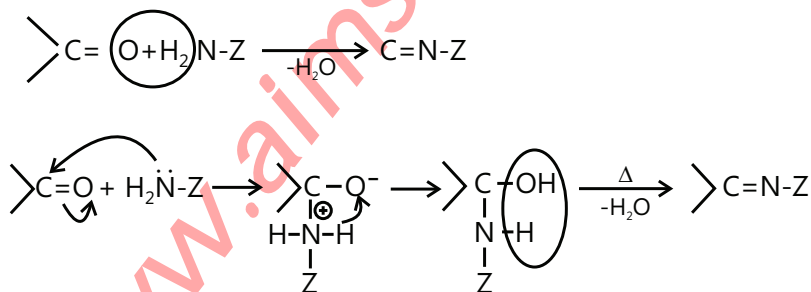
**4.2 Addition Elimination Reactions**

Certain compounds related to ammonia add to the carbonyl group to form derivatives that are important chiefly for the characterization and identification of aldehydes and ketones, the product contains a carbon nitrogen double bond resulting from the elimination of a molecule of water from the initial addition products.

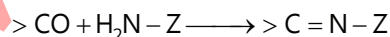


**Reaction with ammonia derivatives (H<sub>2</sub>N-Z):**

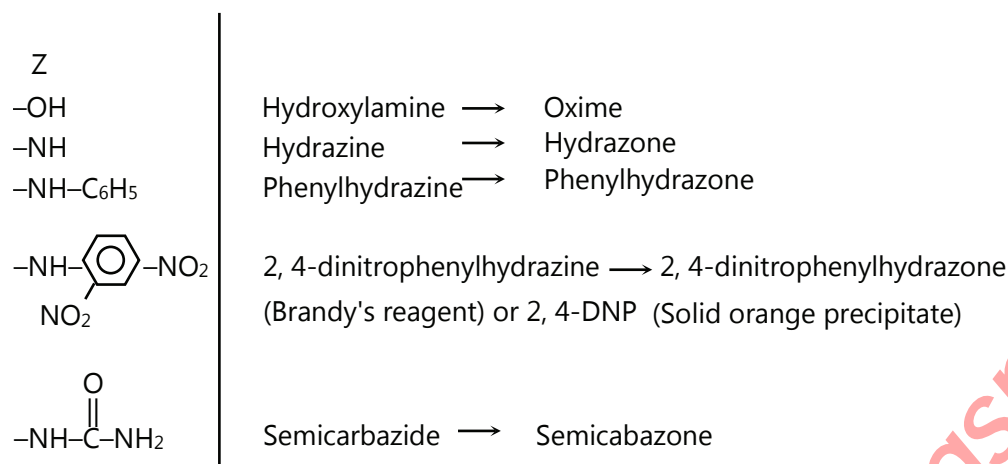
This reaction is a nucleophilic addition followed by water elimination.



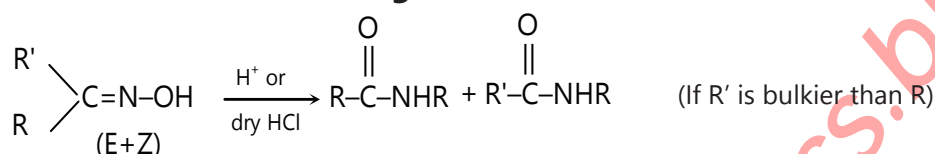
This reaction is carried out in slightly acidic media which will generate a nucleophilic centre for weak base ammonia derivatives. On using strong acidic media lone pair of electrons present at N-atom of ammonia derivatives will accept a proton forming protonated ammonia derivatives which cannot act as a nucleophile for a carbonyl carbon.



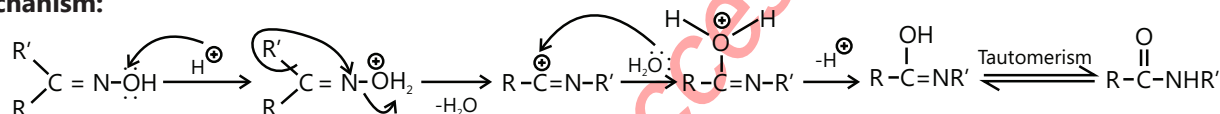




### 4.3 Beckmann's Rearrangement in Oxime

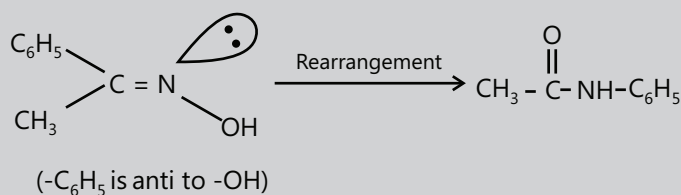
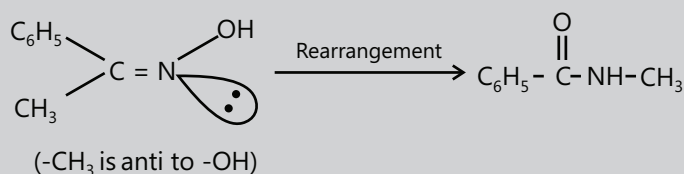
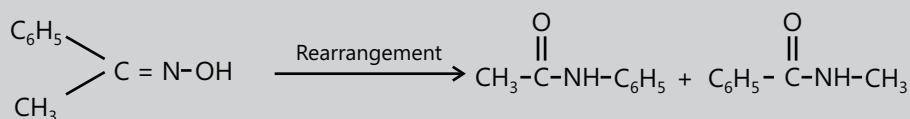


#### Mechanism:



#### PLANCESS CONCEPTS

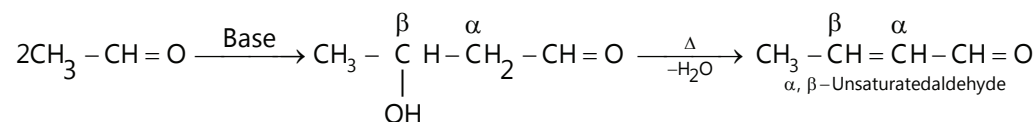
- Brady's reagent is used to distinguish carbonyl compounds from the mixture
- Oxime undergoes Beckmann rearrangement to give its isomer amide.
- In this reaction, the group which is anti -OH group migrates.



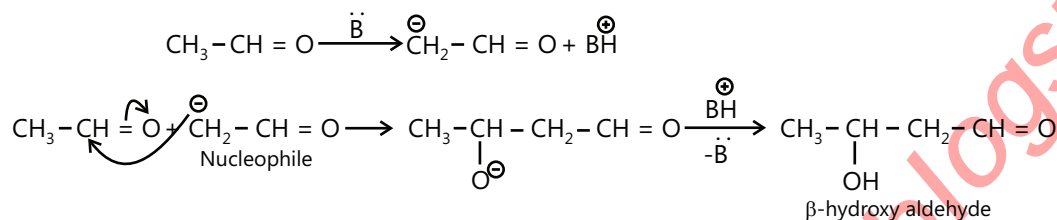
Nikhil Khandelwal (JEE 2009, AIR 94)

## 4.4 Aldol Condensation

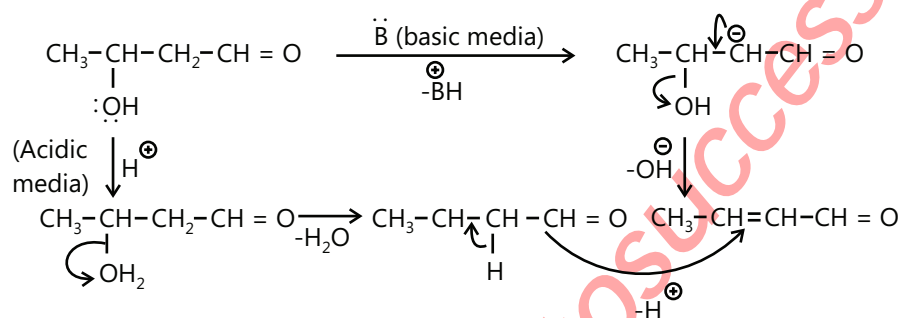
It is condensation between two moles of carbonyl compounds among which at least one must have  $\alpha$ -hydrogen atom in dilute basic media to get  $\alpha, \beta$ -unsaturated aldehyde / ketone via the formation of  $\beta$ -hydroxy aldehyde / ketone.



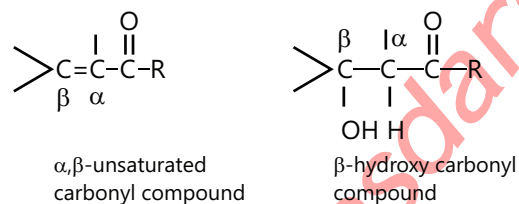
### Mechanism:



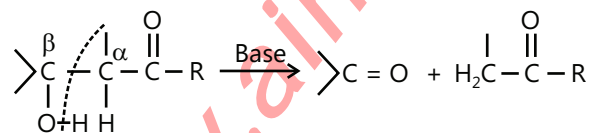
From  $\beta$ -hydroxy aldehyde/ ketone, water is eliminated on using either acidic or basic media.-



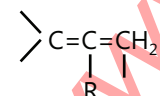
Now try to get carbonyl compounds from  $\alpha, \beta$ -unsaturated carbonyl compounds as - keep 'H' at  $\alpha$ -position and  $-\text{OH}$  at  $\beta$ -position of  $\alpha, \beta$ -unsaturated carbonyl compound to get  $\beta$ -hydroxy carbonyl compound.



Now break  $\alpha$  and  $\beta$  carbon shown below to get carbonyl compound.



These two carbonyl compounds can be obtained on the ozonolysis of hydrocarbon



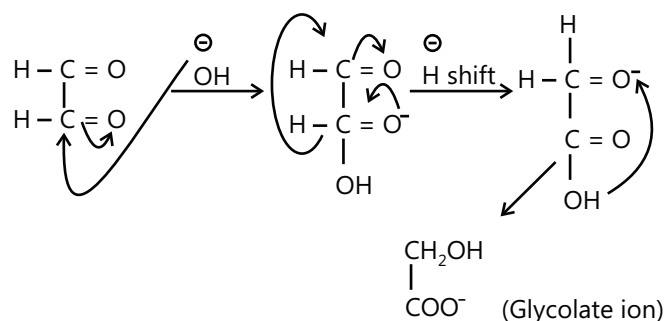
### 4.4.1 Cross Aldol Condensation

On using two type of carbonyl compounds both having  $\alpha$ -hydrogen atoms we get a mixture of four condensed products because two types of carbonyl compounds will give two type of carbanions which will be nucleophile for

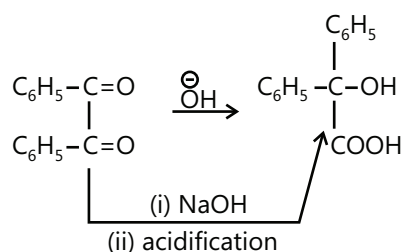




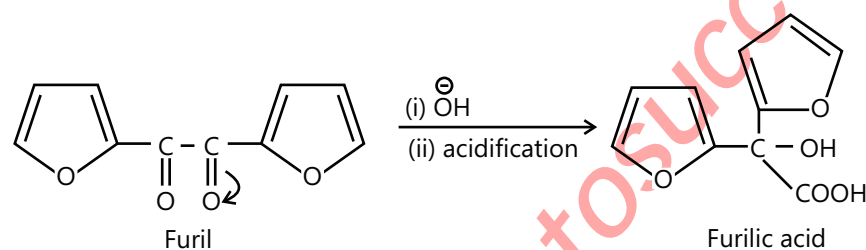
**Mechanism:**



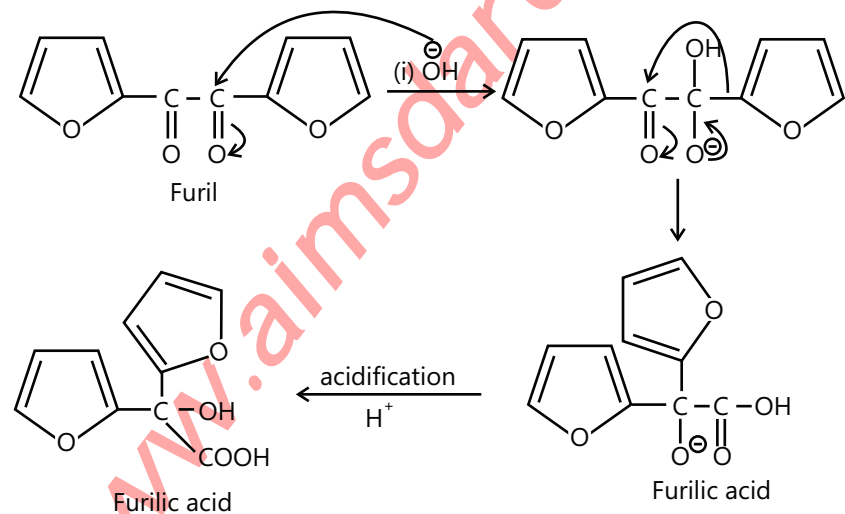
**4.5.3 Benzil – Benzilic Acid Rearrangement**



Other example is

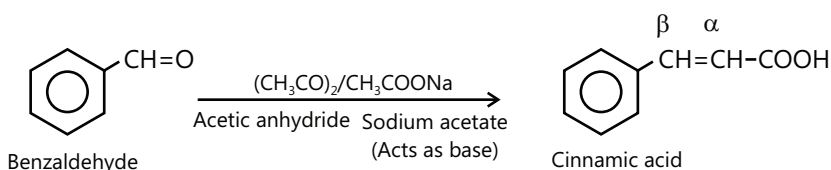
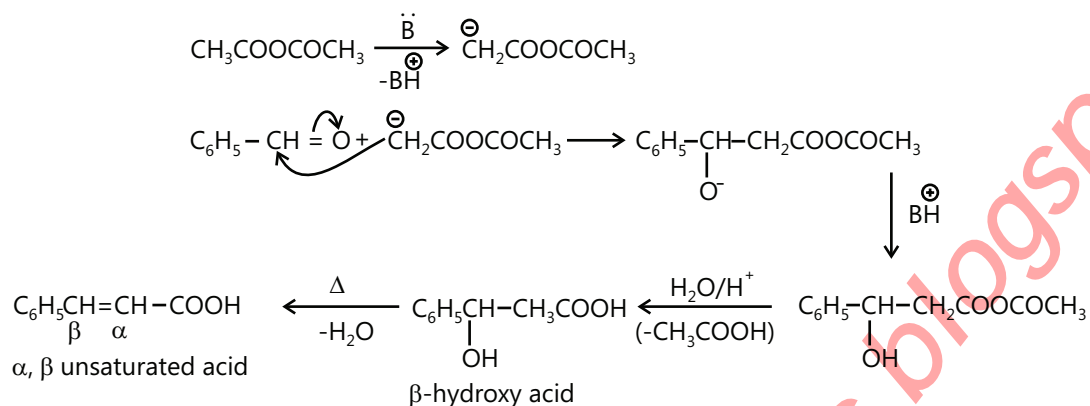


**Mechanism:**



**4.6 Perkin Reaction**

When an aromatic aldehyde like benzaldehyde is treated with an anhydride in the presence of the sodium salt of an acid from which an anhydride is derived we get  $\alpha, \beta$ -unsaturated acid e.g.


**Mechanism:**

**PLANCESS CONCEPTS**

By knowing  $\alpha, \beta$ -unsaturated acid we can get an idea about the anhydride used in the Perkin reaction. This can be done by keeping 'H' at  $\alpha$  and  $-\text{OH}$  at  $\beta$ -carbon atom followed by breaking  $\alpha, \beta$  carbon as given below. By this we can know about acid and it will be anhydride of this only.

**Saurabh Gupta (JEE 2010, AIR 443)**

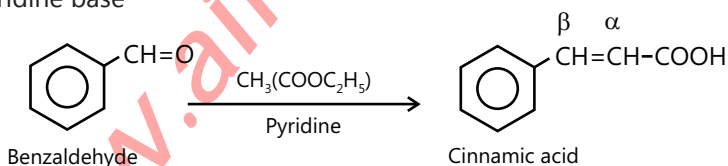
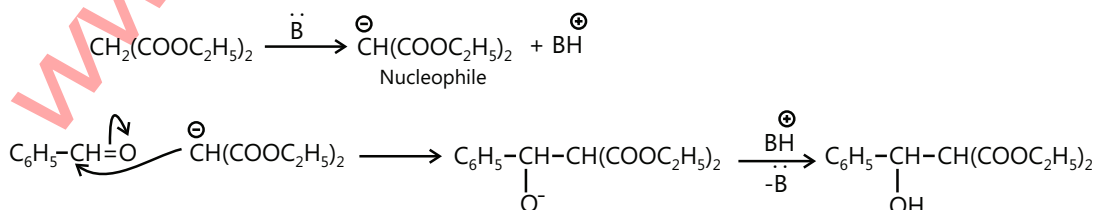
**Illustration 10:** Complete the reaction;  $\text{C}_5\text{H}_5\text{CHO} + \text{CH}_3-\text{COOC}_2\text{H}_5 \xrightarrow[\text{heat}]{\text{NaOC}_2\text{H}_5 \text{ in absolute } \text{C}_2\text{H}_5\text{OH}}$  (D) **(JEE MAIN)**

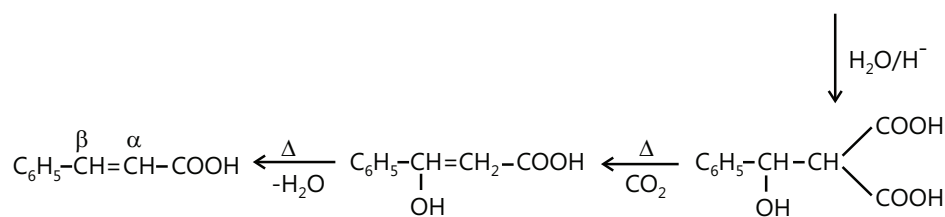
**Sol:** It is an example of Perkin reaction.

The product D is: (D)  $\text{C}_6\text{H}_5-\text{CH}=\text{CHCOOC}_2\text{H}_5$

**4.7 Knoevenagel Reaction**

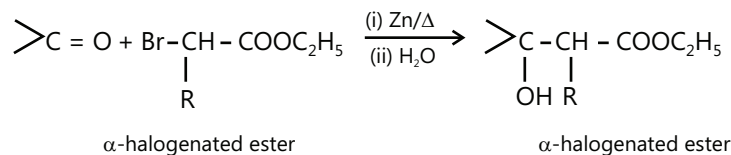
It is the preparation of  $\alpha, \beta$ -unsaturated acid with a carbonyl compound in the presence of a pyridine base


**Mechanism:**


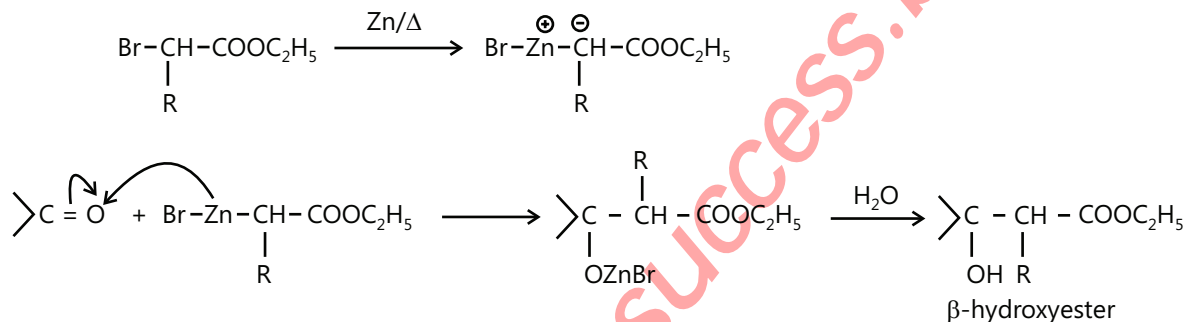


### 4.8 Reformatsky Reaction

When a carbonyl compound and a halogenated ester are heated with zinc followed by treating it with water we get  $\beta$ -hydroxy ester.

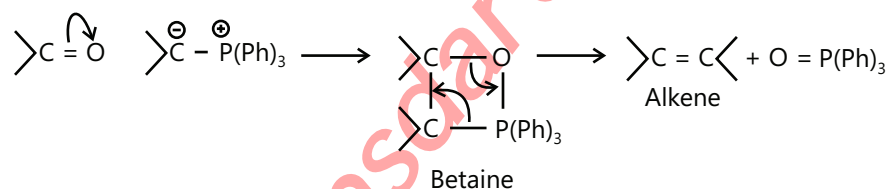


This reaction can be represented as -



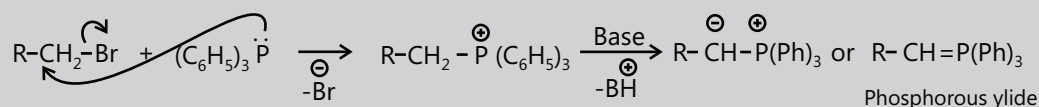
### 4.9 Wittig Reaction

The Wittig Reaction is used in order to get an alkene from a carbonyl compound using phosphorous ylide via the formation of cyclic structure betaine.



#### PLANCESS CONCEPTS

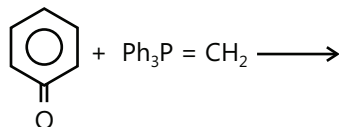
Phosphorous ylides are prepared from alkylhalide and triphenylphosphine in the presence of base like sodium ethoxide as -



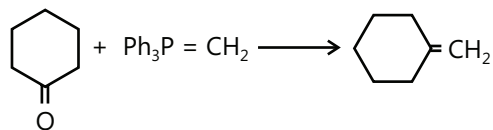
Neeraj Toshniwal (JEE 2009, AIR 21)

**Illustration 11:** Complete the following reaction:

(JEE MAIN)

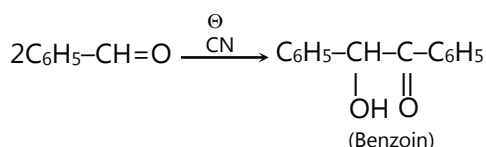


**Sol:** The above reaction is the Wittig reaction.

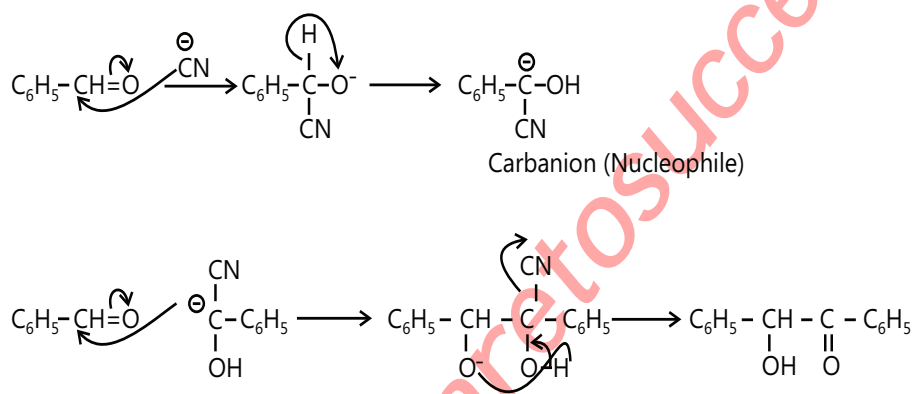


### 4.10 Benzoin Condensation

During this reaction, benzoin is obtained when an ethanolic solution of benzaldehyde is heated with a strong alkali like potassium cyanide or sodium cyanide.

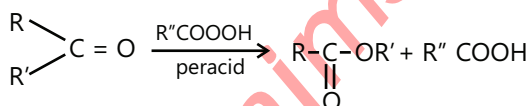


**Reaction Mechanism:**

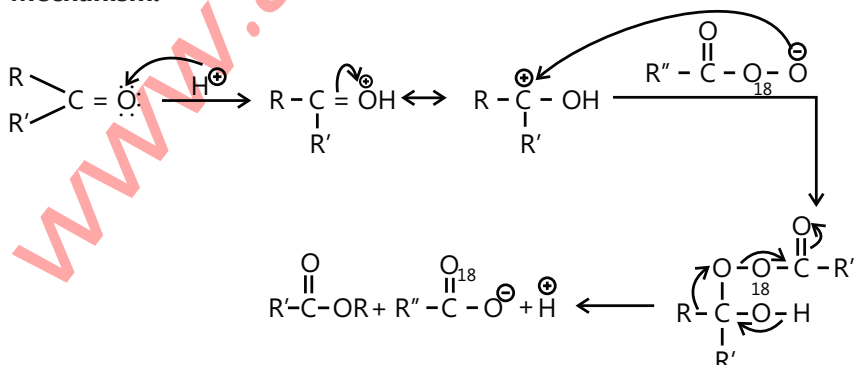


### 4.11 Baeyer-Villiger Oxidation

It is preparation of an ester from a ketone using peracid-



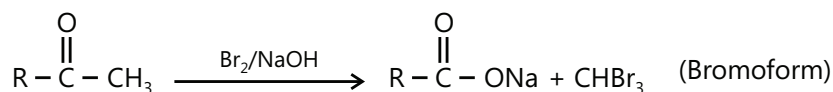
**Mechanism:**





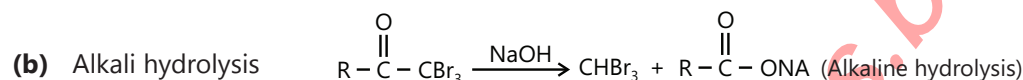
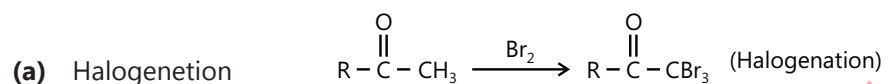
### 4.12 Haloform Reaction

Acetaldehyde and methylalkyl ketones react rapidly with halogens ( $\text{Cl}_2$ ,  $\text{Br}_2$ , or  $\text{I}_2$ ) in the presence of an alkali to give a haloform and acid salt.



In this reaction  $-\text{CH}_3$  of  $\text{CH}_3-\overset{\text{O}}{\parallel}{\text{C}}-$  group is converted into a haloform, as it contains an acidic hydrogen atom and the rest of alkyl methyl ketone gives an acid salt having a carbon atom corresponding to alkyl ketone.

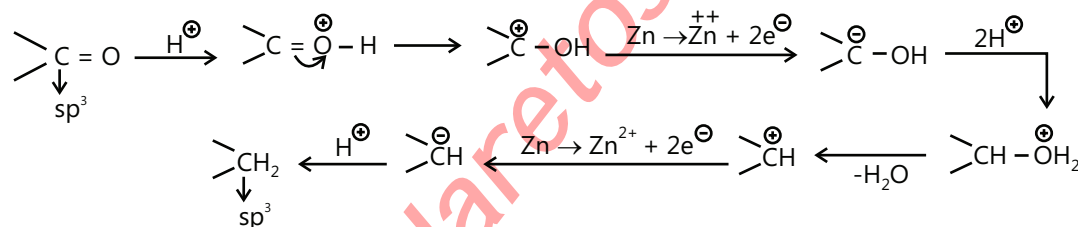
Preparation of haloform from methylketone involves two steps



### 4.13 Clemmensen Reduction

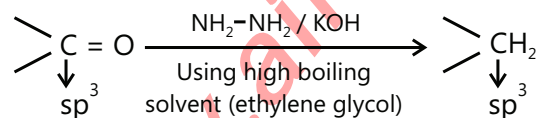
Used to get alkane from carbonyl compounds.  $\text{>C}=\text{O} \xrightarrow{\text{Zn-Hg/HCl}} \text{>CH}_2$

**Mechanism:**

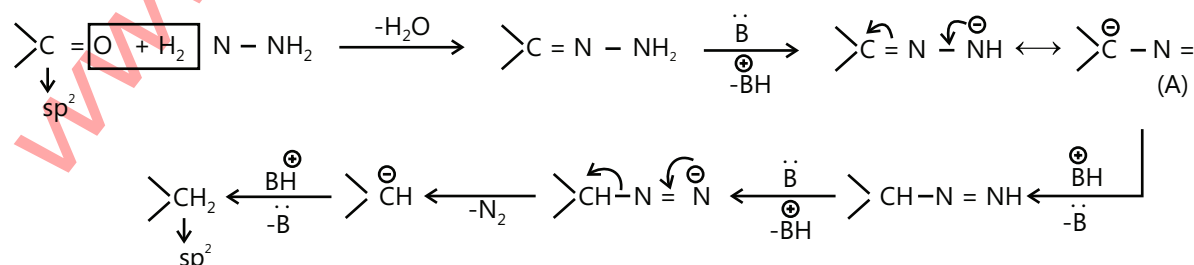


### 4.14 Wolf Kishner Reduction

Used to get alkane from carbonyl compounds

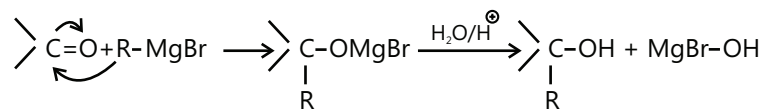


**Mechanism:**

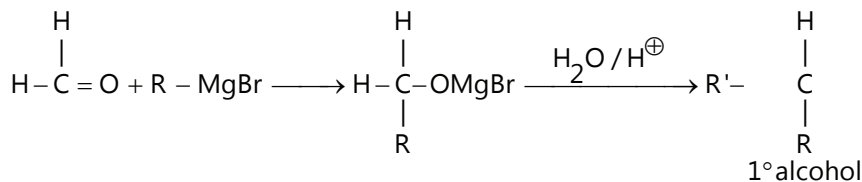


### 4.15 Addition of Grignard Reagent Over Carbonyl Compounds

It gives alcohol

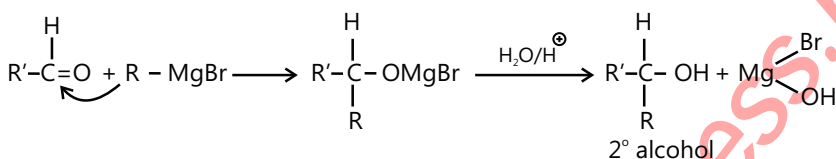


(i) When formaldehyde is treated with Grignard reagent

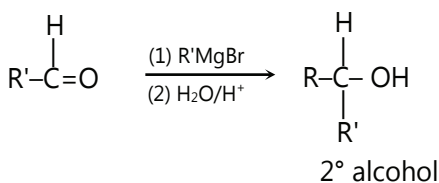


Followed by acid hydrolysis, a primary alcohol is obtained

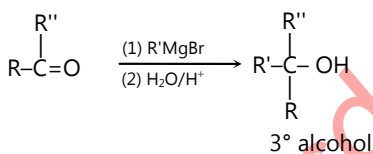
(ii) When an aldehyde except formaldehyde is treated with Grignard reagent followed by hydrolysis, we get 2° alcohol



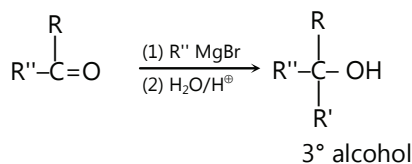
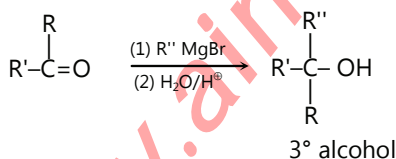
This 2° alcohol is also obtained as -



(iii) When a ketone is treated with Grignard reagent followed by acid hydrolysis, it gives 3° alcohol



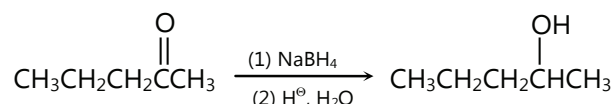
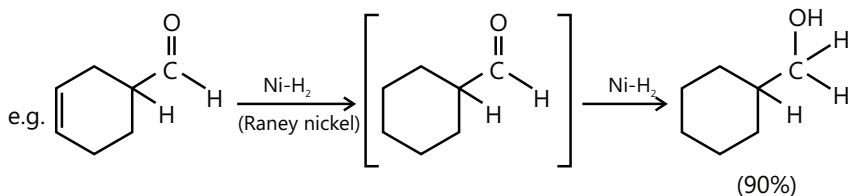
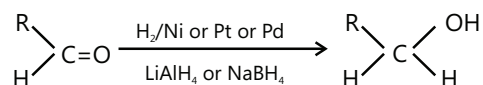
This 3° alcohol is also obtained by using the following two methods



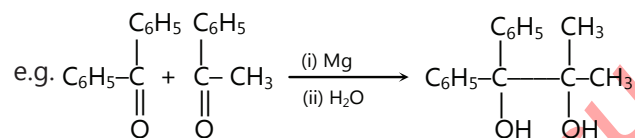
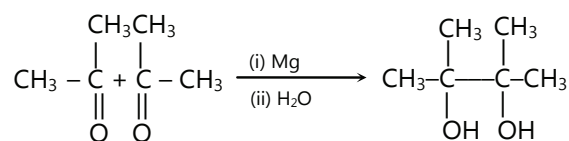
**Note:** 2° alcohol on oxidation gives a ketone

### 4.16 Reduction of Carbonyl Compounds

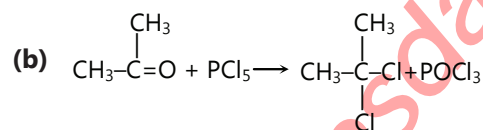
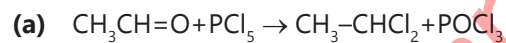
(a) Reduction to alcohols



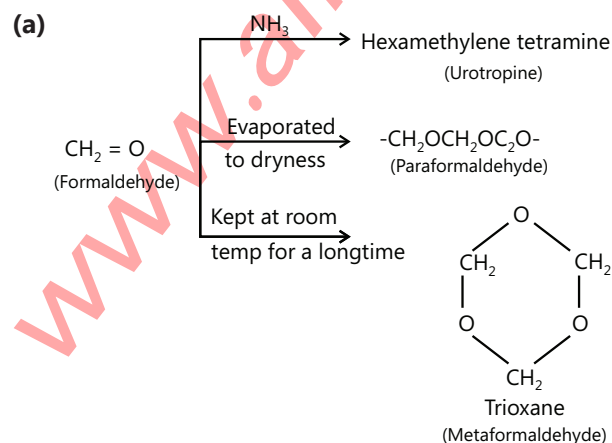
(b) Reduction to pinacols

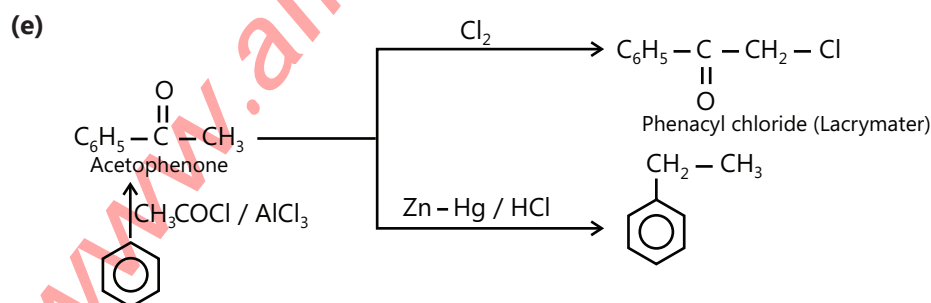
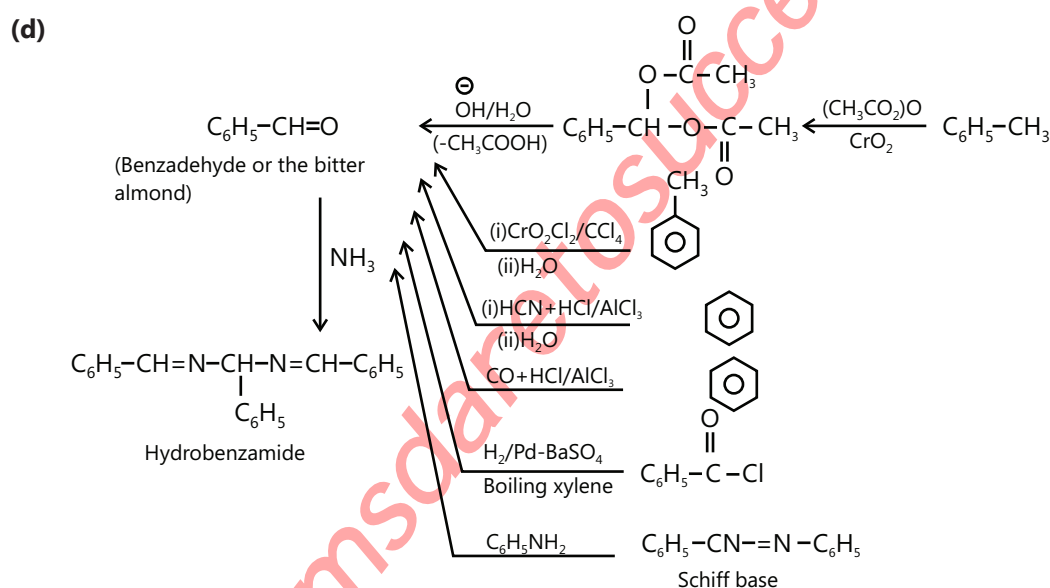
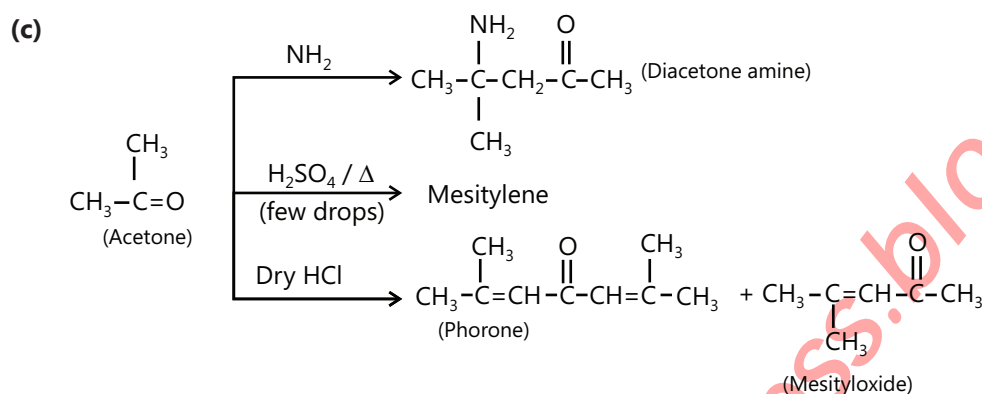
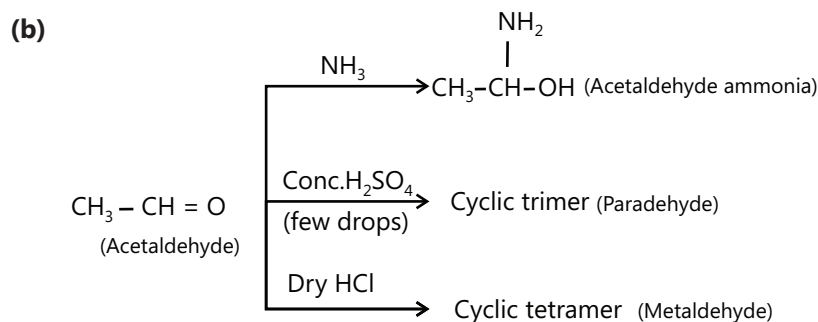


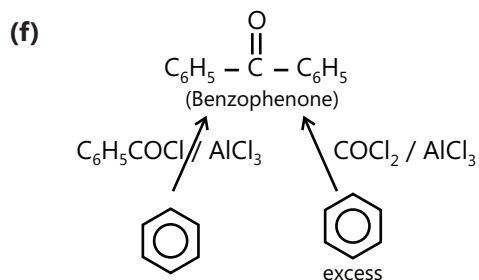
### 4.17 Reaction with PCl<sub>5</sub>



### 4.18 Other Reactions

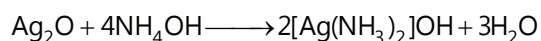
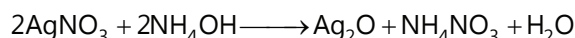




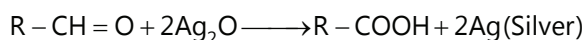
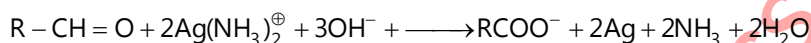


#### 4.19 Some Important Reagents used for the Identification of Aldehydes

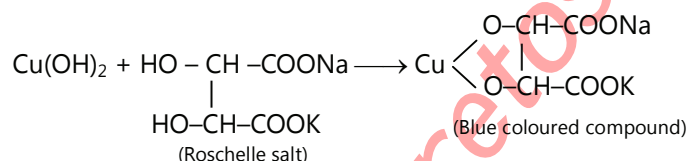
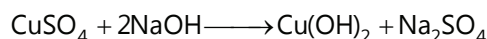
(a) **Tollen's reagent:** It is ammoniacal silver nitrate solution, prepared by the addition of ammonium hydroxide to  $\text{AgNO}_3$  solution. During the reaction, first  $\text{Ag}_2\text{O}$  is formed which is dissolved in ammonium hydroxide to give Tollen's reagent



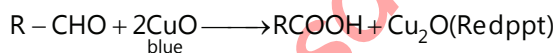
Tollen's reagent is a weak oxidizing agent. It gives Ag mirror test with an aldehyde.



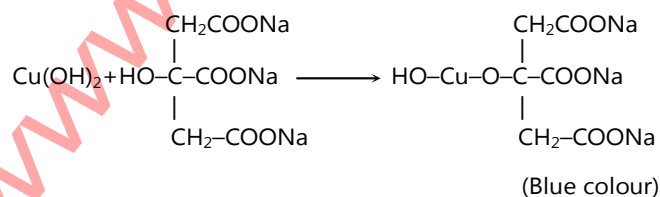
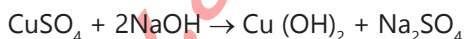
(b) **Fehling's solution:** It is an alkaline solution of cupric ion complexed with sodium potassium tartarate. Two solutions are kept by naming Fehling solution (I) ( $\text{CuSO}_4$  solution) and Fehling solution (II) (Alkaline solution of sodium potassium tartarate). When these two solutions are mixed we get deep blue coloured solution.



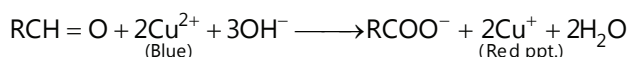
Equal volume of both the solutions are heated with aldehyde to give red brown precipitate of cuprous oxide ( $\text{Cu}_2\text{O}$ ) which confirms the presence of aldehyde.



(c) **Benedict solution:** It is solution of  $\text{CuSO}_4$ , Sodium citrate and sodium carbonate. It also consists of two solutions. Solution (I) is alkaline solution of sodium citrate and solution (II) is  $\text{CuSO}_4$  solution.

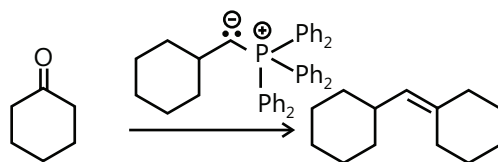


Aldehyde gives positive test with Benedict solution

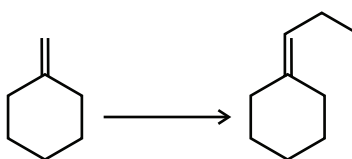




Method 2 is likely to be efficient, because a primary alkyl halide will undergo  $S_N2$  more rapidly than a secondary alkyl halide. Therefore, the following would be the preferred synthesis.



**Problem 2:** Propose an efficient synthesis for the following



**Sol:** Always begin a synthesis problem by asking the following two questions.

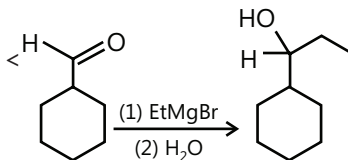
**Step 1:** Inspect whether there is a change in the carbon skeleton and /or a change in the identity or location of the functional group.

1. Is there any change in the carbon skeleton? Yes. The product has two additional carbon atoms.
2. Is there any change in the functional groups? No. Both the starting material and the products have a double bond in the exact same location. If we destroy the double bond in the process of adding the two carbon atoms we will need to make sure that we do so in such a way that we can restore the double bond. Now, let's consider how we might install the additional two-carbon atoms. The following C–C bond is the one that needs to be made. In this chapter, we have seen a C–C bond-forming reaction, let's consider each one as possible.

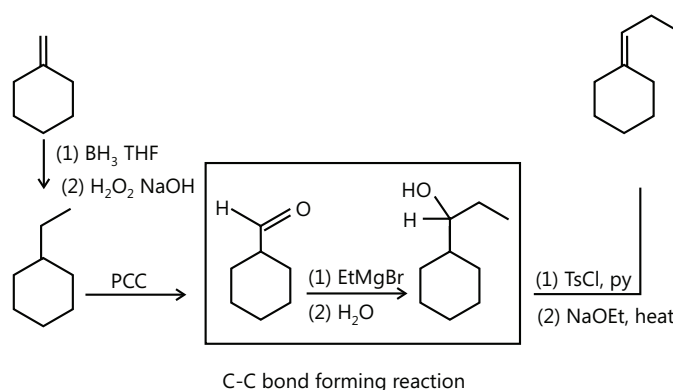


**Step 2:** When there is a change in the carbon skeleton, consider all of the C–C bond-forming reactions and all of the C–C bonds. Breaking the reaction that you have formed so far.

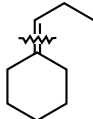
We can immediately rule out cyanohydrin formation, as that process installs only one carbon atom, not two. So, let's consider forming the C–C bond with either a Grignard reaction or a Wittig reaction. A Grignard reagent won't attack a C=C double bond into a functional group that can be attacked by a Grignard reagent, such as a carbonyl group.



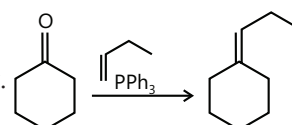
This reaction can indeed be used to form the crucial C–C bond. To use this method of C–C bond formation, we must first form the necessary aldehyde, then perform the Grignard reaction, and then finally restore the double bond in its proper location. This can be accomplished with the following reagents.



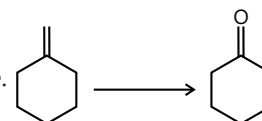
This provides us with a four-step procedure, and this answer is certainly reasonable. Let's now explore the possibility of proposing a synthesis with a Wittig reaction. Recall that a Wittig reaction can be used to form a C=C bond, so we focus on the formation of this bond



This bond can be formed if we start with a ketone and use the following Wittig reagent.

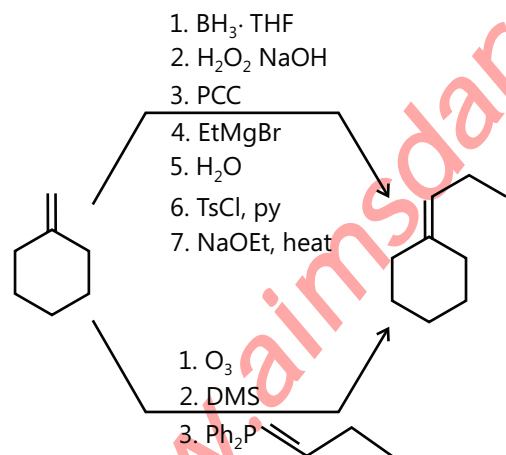


To use this reaction we must first form the necessary ketone from the starting alkene.

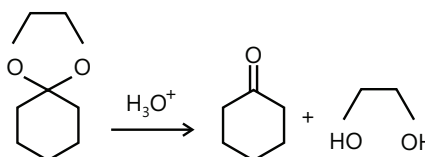


This can be accomplished with ozonolysis. This gives a two-step procedure for accomplishing the desired transformation: Ozonolysis followed by a Wittig reaction. This approach is different from our first answer. In this approach, we are not attaching a two-carbon chain, but rather, we are first expelling a carbon atom and then attaching a three-carbon chain

In short, there are two plausible methods have been discovered. Both methods are correct answers to this problem, however the method employing the Wittig reaction is likely to be more efficient, because it requires fewer steps.

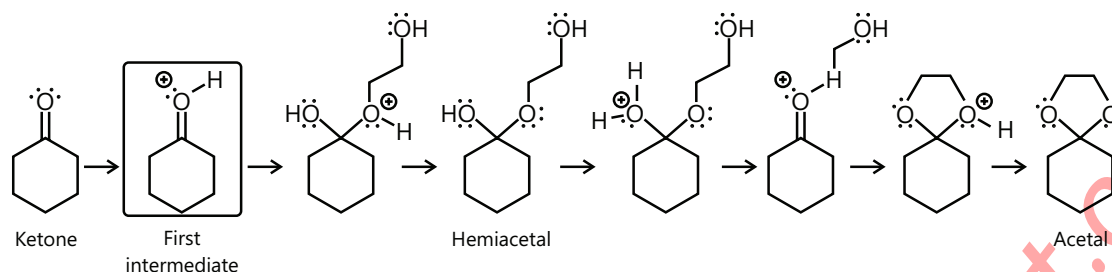


**Problem 3:** Propose a mechanism for the following transformation:



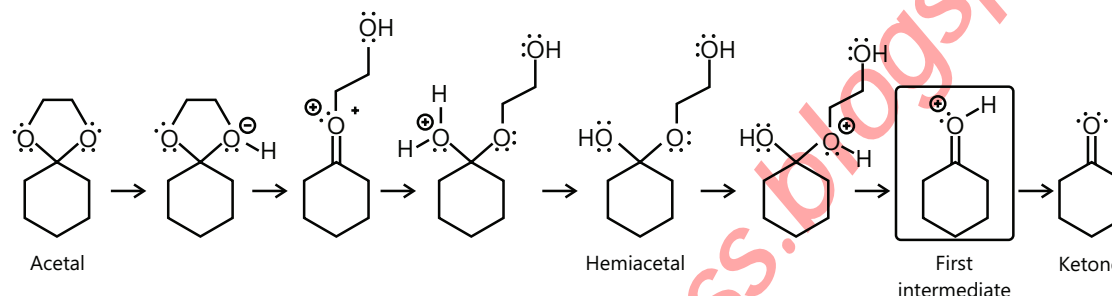
**Sol:** This is a hydrolysis reaction in which a cyclic acetal is opened to form a ketone. We therefore expect the mechanism to be the reverse of acetal formation. Begin by considering all of the intermediates in acetal formation



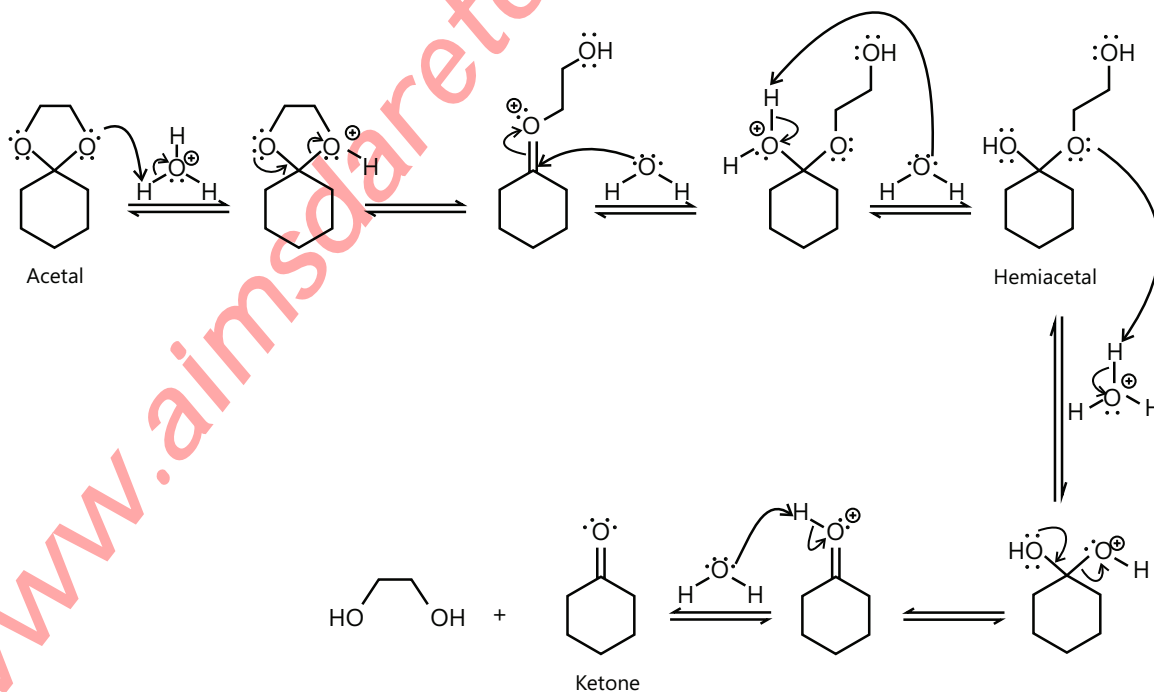


**Step: 1** Draw all intermediates for acetal formation in reverse order

We simply draw all of these intermediates in reverse order so that the first intermediate above (Highlighted) becomes the last intermediate of the hydrolysis mechanism.



Hydrolysis of the acetal must involve these intermediates, in the order shown above. If any of the intermediates has a negative charge, then a mistake has been made. With the intermediates placed in the correct order, the final step is to draw the reagents and curved arrows that show how each intermediate is transformed into the next intermediate. Begin with the acetal, and work forward until reaching the ketone. Make sure to use only the reagents that are provided, and obey the master rule for proton transfer. For example this problem indicates that  $\text{H}_3\text{O}^+$  is available. This means that  $\text{H}_3\text{O}^+$  should be used for protonating, and  $\text{H}_2\text{O}$  should be used for deprotonating. Do not use hydroxide ions, as they are not present in sufficient quantity under acid-catalyzed conditions, Application of these rules gives the following answer?

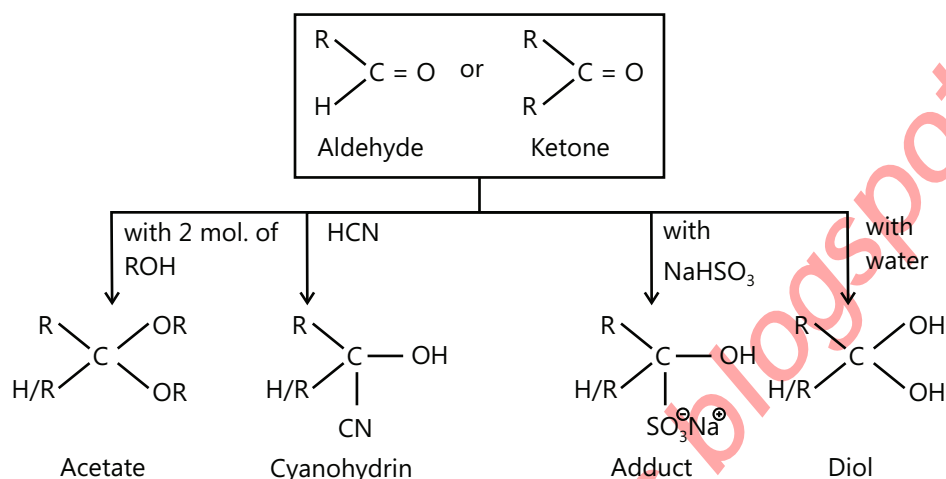


**Step: 2** Draw the curved arrows and necessary reagents for each step of the mechanism

Notice the use of equilibrium arrows, because the process is governed by an equilibrium, as noted in the previous section.

## POINTS TO REMEMBER

### Nucleophilic Addition Reactions:

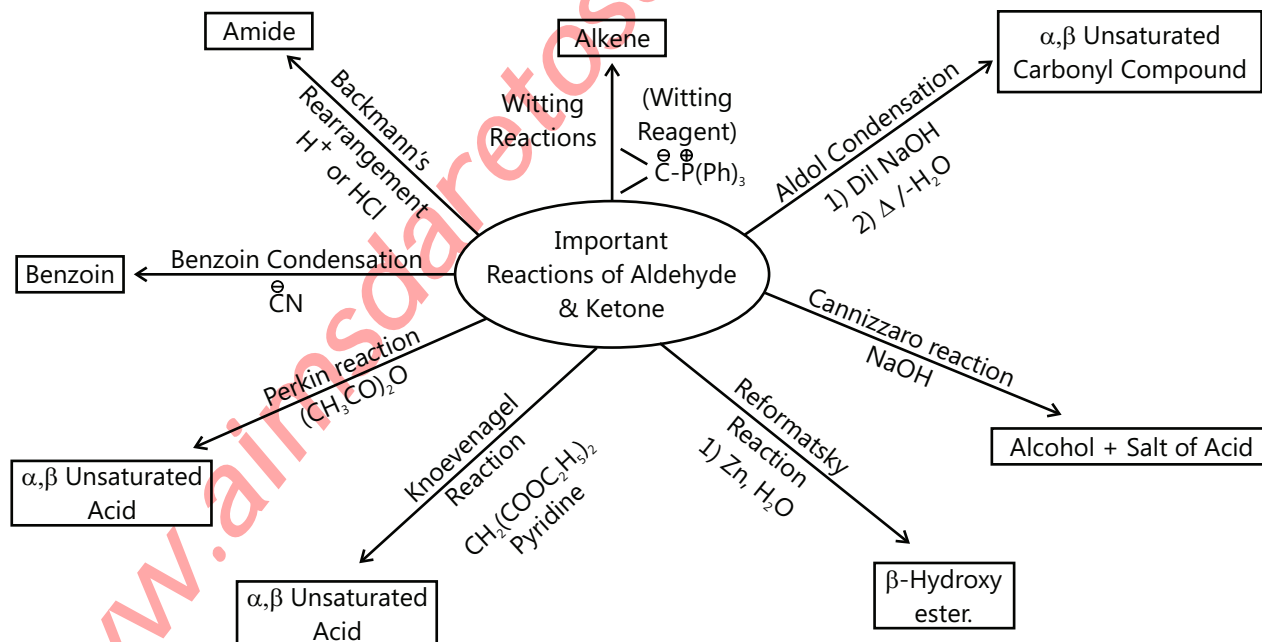


### Reagents used to identify Aldehyde and Ketone:

No.	Reagent	Reactant	Product
1.	<b>Tollen's Reagent:</b> (Ammoniacal solution of AgNO <sub>3</sub> ) $[\text{Ag}(\text{NH}_3)_2]^+ \text{OH}^-$ Also known as silver mirror Test.	$\begin{array}{c} \text{O} \\    \\ \text{R}-\text{C}-\text{H} \end{array} \rightarrow$	$\begin{array}{c} \text{O} \\    \\ \text{R}-\text{C}-\text{O}^- + \text{Ag} \end{array}$ Silver mirror
		α, β -Unsaturated Aldehyde. $\text{RCH}=\text{CH}-\text{CHO} \rightarrow$	$\text{R}-\text{CH}=\text{CH}-\text{COO}^\ominus + \text{Ag mirror}$
		α -hydroxy ketone $\begin{array}{c} \text{R}-\text{C}-\text{H}-\text{C}-\text{R} \\   \quad    \\ \text{OH} \quad \text{O} \end{array} \rightarrow$	$\begin{array}{c} \text{R}-\text{C}+\text{C}-\text{R} \\    \quad    \\ \text{O} \quad \text{O} \end{array} + \text{Ag mirror}$
		Ketone	No reaction
2.	<b>Fehling's solution:</b> Ammoniacal solution of CuSO <sub>4</sub> + Rochelle salt. i.e. – sodium potassium tartarate	$\begin{array}{c} \text{O} \\    \\ \text{R}-\text{C}-\text{H} \end{array} \rightarrow$	$\text{RCOO}^- + \text{Cu}_2\text{O}$ (Red ppt)
		α, β -Unsaturated aldehyde $\text{R}-\text{CH}=\text{CH}-\text{CHO} \rightarrow$	$\text{R}-\text{CH}=\text{CH}-\text{COO}^\ominus + \text{Cu}_2\text{O}$
		α - hydroxyl ketone $\begin{array}{c} \text{R}-\text{CH}-\text{C}-\text{R} \\    \quad    \\ \text{O} \quad \text{O} \end{array}$	$\begin{array}{c} \text{R}-\text{C}-\text{C}-\text{R} \\    \quad    \\ \text{O} \quad \text{O} \end{array} + \text{Cu}_2\text{O}$
		Ketone	No red ppt.
3.	<b>Schiff's reagent</b> Containing rosaniline hydrochloride in H <sub>2</sub> O, whose red colours is decolourised with SO <sub>2</sub> .	Schiff's reagent + Aldehyde	Red colour of dye is restored.

No.	Reagent	Reactant	Product
4.	<b>Benedict's solution:</b> (Ammoniacal solution of $\text{CuSO}_4$ + sodium citrate) $[\text{Cu}(\text{NH}_3)_4]_2 + (\text{OH}^{2-})_2$	$\begin{array}{c} \text{O} \\    \\ \text{R}-\text{C}-\text{H} \end{array} \rightarrow$ $\alpha, \beta$ -Unsaturated aldehyde $\text{R}-\text{CH}=\text{CH}-\text{CHO} \rightarrow$ $\alpha$ -hydroxy ketone $\begin{array}{c} \text{R}-\text{C}-\text{H}-\text{C}-\text{R} \\   \quad    \\ \text{OH} \quad \text{O} \end{array} \rightarrow$ Ketone	$\text{RCOO}^- + \text{Cu}_2\text{O}$ (Red ppt)  $\text{R}-\text{CH}=\text{CH}-\text{COO}^- + \text{Cu}_2\text{O}$ (Red ppt)  $\text{R}-\text{C}-\text{C}-\text{R} + \text{Cu}_2\text{O}$ $\quad    \quad   $ $\quad \text{O} \quad \text{O}$ (Red ppt)  No reaction (No red ppt)
5.	<b>Haloform or Iodoform</b> or Hypohalite oxidation  $\text{NaOH} + \text{x}_2$ Or $\text{KOH} \text{x}_2 = \text{I}_2$ Or $\text{Ca}(\text{OH})_2$	Aldehyde or ketone containing 3 $\alpha$ H atom (methyl ketone)  $\begin{array}{c} \text{O} \\    \\ \text{CH}_3-\text{C}-\text{H} \end{array} \rightarrow$  $\begin{array}{c} \text{O} \\    \\ \text{CH}_3-\text{C}-\text{CH}_3 \end{array} \rightarrow$	$\begin{array}{c} \text{O} \\    \\ \text{CH}_3-\text{C}-\text{O}^- \end{array} + \text{CHI}_3$ (yellow)  $\begin{array}{c} \text{O} \\    \\ \text{CH}_3-\text{C}-\text{O}^- \end{array} + \text{CHI}_3$ (yellow)

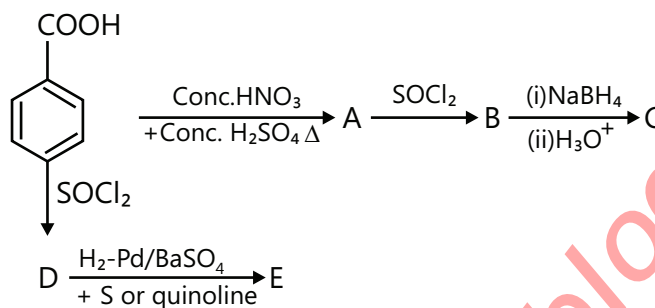
**Important Reaction Flow Chart:**



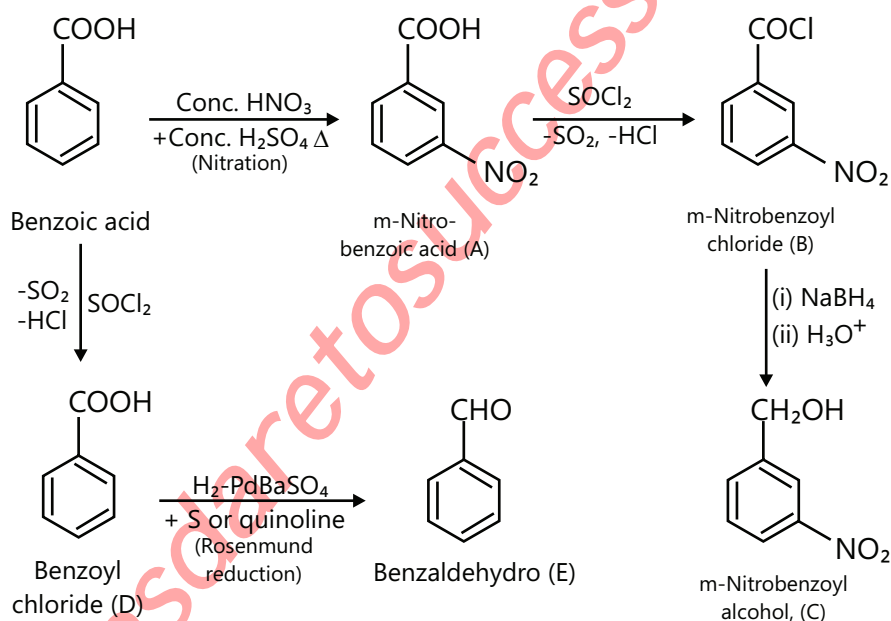
## Solved Examples

### JEE Main/Boards

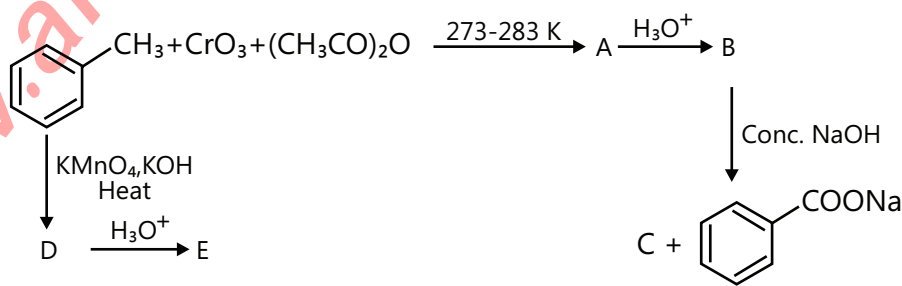
**Example 1:** Identify A to E in the following reactions:



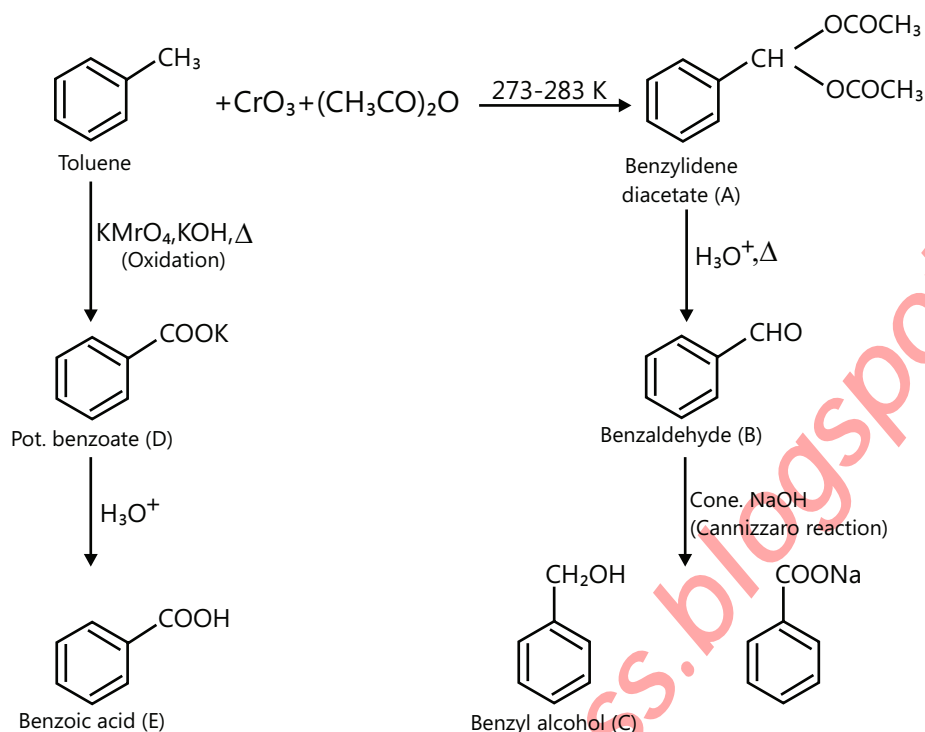
**Sol:** The first step is nitration, the reaction with  $\text{SOCl}_2$  forms an acid chloride derivative, which on Rosenmund reduction forms a formyl group whereas the acid chloride derivative on reduction with  $\text{NaBH}_4$  gives an alcohol.



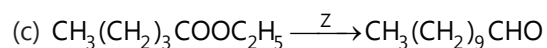
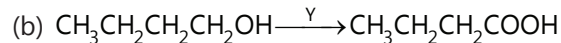
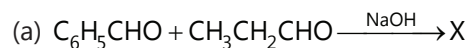
**Example 2:** Identify A to E in the following series of reactions:



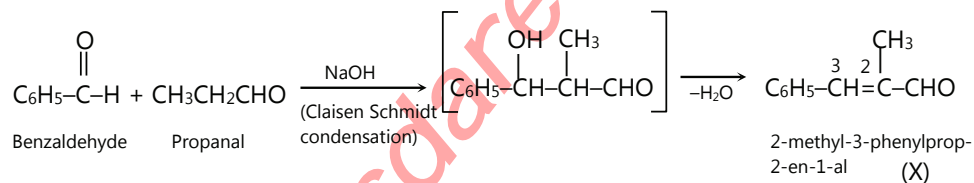
**Sol:** Toluene with  $\text{KMnO}_4/\text{KOH}$  undergoes oxidation to form Benzoic acid. On the other side, toluene with chromium oxide and acetyl acetate gives benzylidene acetate which on treatment with an acid gives aldehyde which on reaction with a strong base undergoes the Cannizzaro reaction.



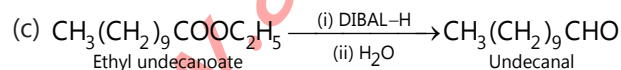
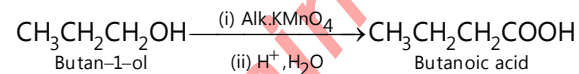
**Example 3:** Complete each synthesis by filling the missing starting materials, reagents or products (X, Y and Z).



**Sol:** (a) The reaction is Claisen-Schmidt condensation.



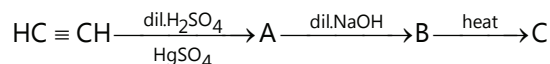
(b) Oxidation of alcohol to acid thus the reagent used must be  $\text{KMnO}_4$



Thus, Y = (i) Alk.  $\text{KMnO}_4$ , (ii)  $\text{H}^+$ ,  $\text{H}_2\text{O}$

And Z = (i) DiBAL-H, (iii)  $\text{H}_2\text{O}$

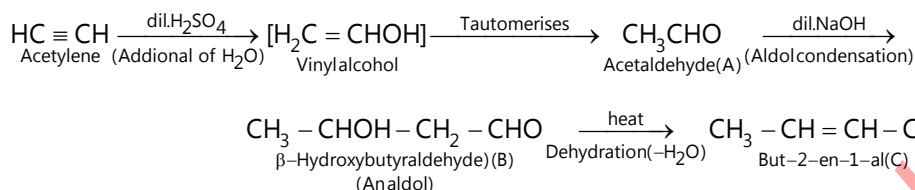
**Example 4:** (a) Identify A, B and C in the following reaction



(b) Give reasons: (i) p-Nitrobenzoic acid has higher  $K_a$  value than benzoic acid

(ii) Acetone is highly soluble but benzophenone is not

**Sol:** (a) The first step is conversion of the alkyne to an unsaturated alcohol, which then tautomerises to form an aldehyde. When this aldehyde is treated with dil NaOH and undergoes self-condensation, reaction known as aldol which form  $\beta$ -hydroxyl carbonyl compound. On heating it gives  $\alpha,\beta$  unsaturated carbonyl compound.



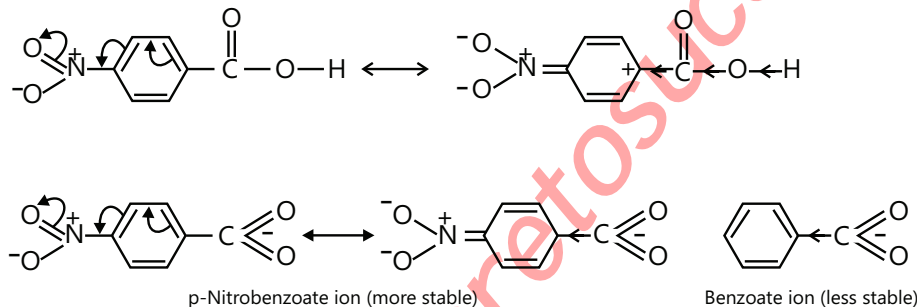
**Sol:** (b) (i) Higher the  $K_a$  stronger is the acid.

p-nitrobenzoic acid is a stronger acid than benzoic acid. This is due to the following two reasons:

I. Due to -I and -R effect of the  $-\text{NO}_2$  group, the electron density in the O-H bond decreases. As a result, the O-H bond becomes weak and hence p-nitrobenzoic acid more easily loses a proton than benzoic acid.

II. Due to -I and R-effect of the  $\text{NO}_2$  group, dispersal of the -ve charge occurs and hence

p-nitrobenzoate ion becomes more stable than the benzoate ion.



(ii) This is because, the carbonyl group of Acetone easily forms Hydrogen bonds with water and hence acetone is highly soluble in water.

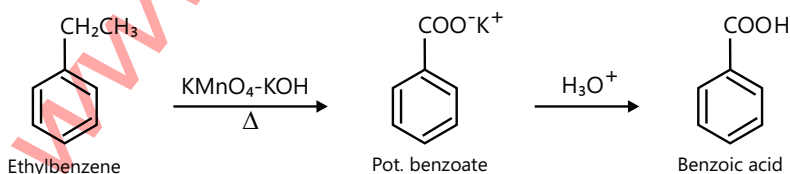
However, in Benzophenone, the phenyl groups are larger and hence  $\text{C} = \text{O}$  group cannot form hydrogen bonds with water due to steric crowding. Benzophenone is thus insoluble in water.

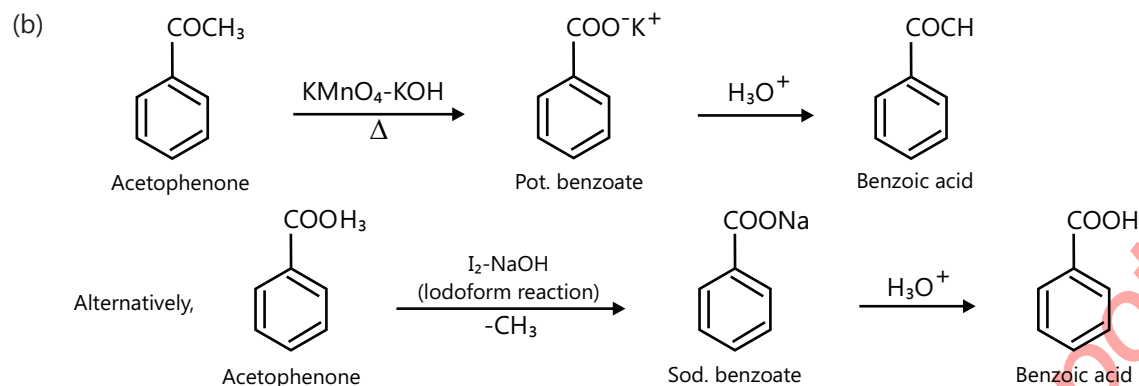
**Example 5:** Show how each of the following compounds could be converted to benzoic acid

(i) Ethylbenzene (ii) Acetophenone (iii) Bromobenzene (iv) Phenylethene (Styrene)

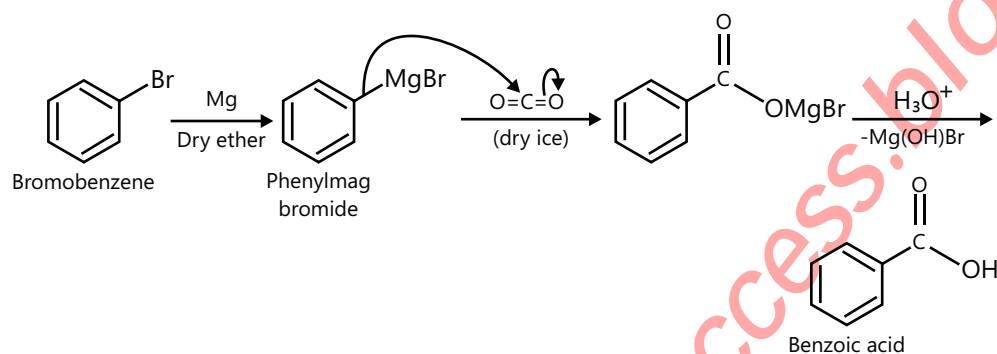
**Sol:** First step is oxidation with  $\text{KMnO}_4$  and  $\text{KOH}$  to form Potassium Benzoate followed by treatment with acid.

(a) This can be achieved by treating it with  $\text{KMnO}_4$ - $\text{KOH}$  followed by treatment with acid.

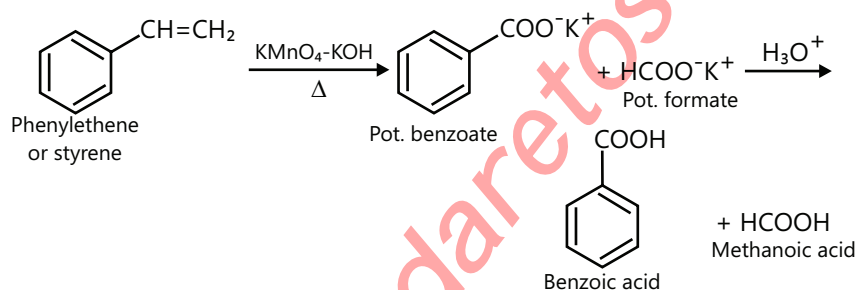




(c) First of all we have to prepare the Grignard reagent. It is prepared by treating Bromobenzene with Mg in dry ether. Now this Grignard reagent is treated with dry ice followed by hydrolysis to form Benzoic acid.



(d) This can be achieved by following the same process of  $\text{KMnO}_4\text{-KOH}$  and acid.



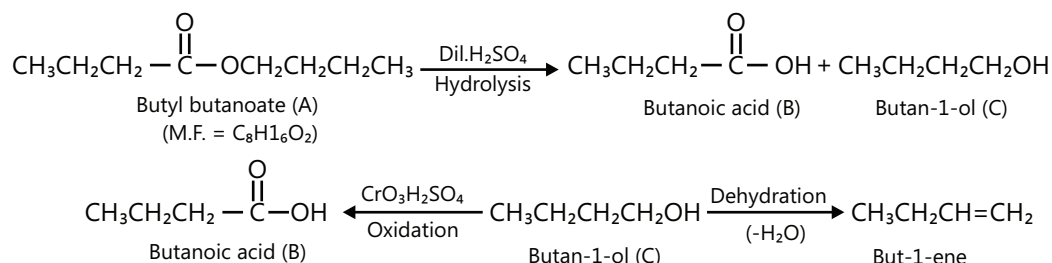
**Example 6:** An organic compound A (molecular formula  $\text{C}_8\text{H}_{16}\text{O}_2$ ) was hydrolysed with dilute sulphuric acid to give a carboxylic acid (B) and an alcohol (C) Oxidation of (C) with chromic acid produced (B). (C) on dehydration gives but-1-ene. Write equations for the reactions involved.

**Sol:** (i) Since the organic compound (A) on hydrolysis with dil.  $\text{H}_2\text{SO}_4$  gives carboxylic acid (B) and the alcohol (C) therefore, (A) must be an ester. Further, since the oxidation of (C) with chromic acid produces the acid (B) therefore both the carboxylic acid (B) and the alcohol (C) must contain the same number of carbon atoms.

(ii) Since the ester (A) contains eight carbon atoms, therefore both the carboxylic acid (B) and the alcohol (C) must contain four carbon atoms each.

(iii) (C) on dehydration gives but-1-ene, therefore, (C) must be a straight chain alcohol. i.e. butan-1-ol.

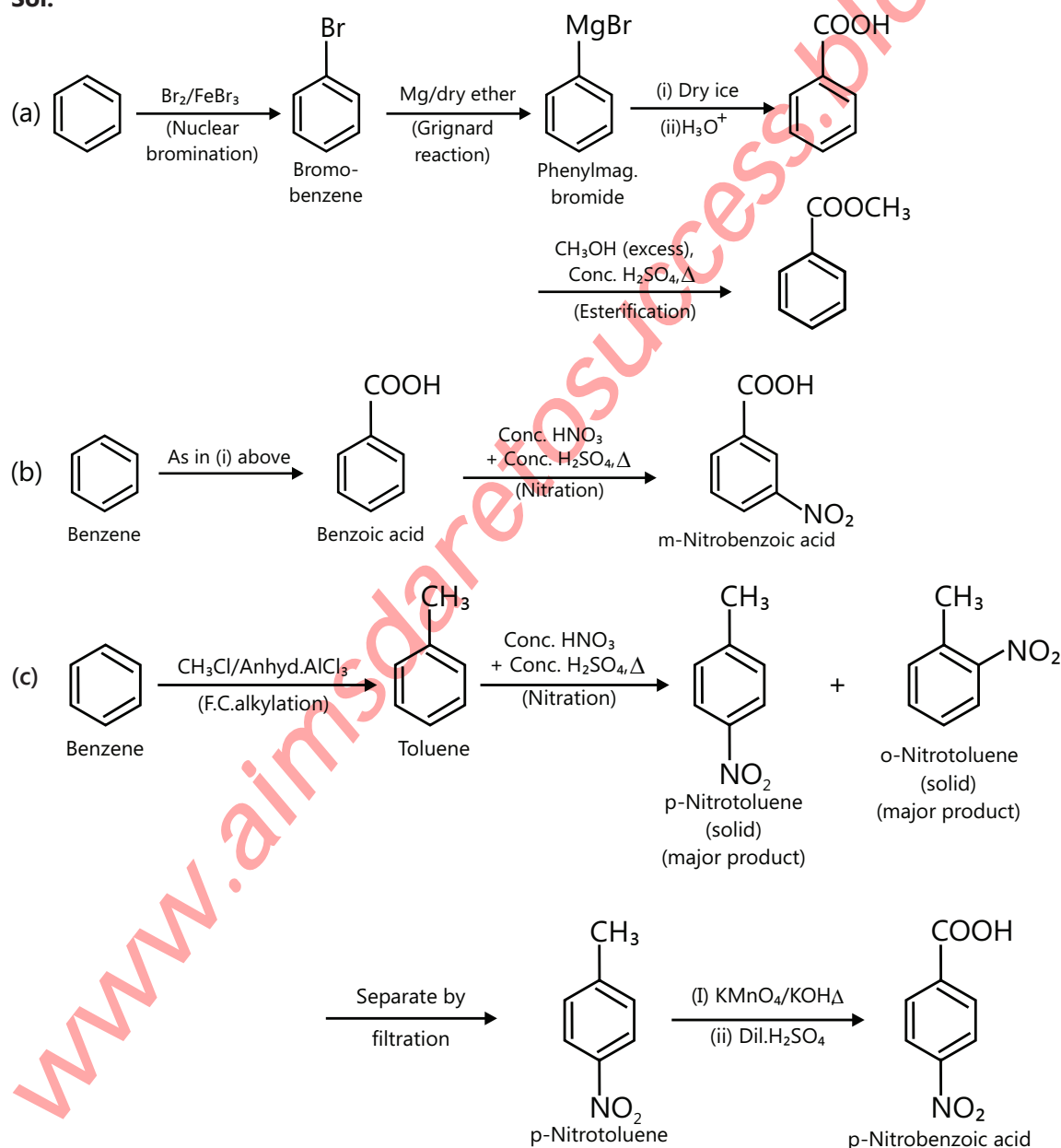
(iv) If (C) is butan-1-ol, then acid (B) which is gives on oxidation must be butanoic acid and the ester (A) must be butyl butanoate.



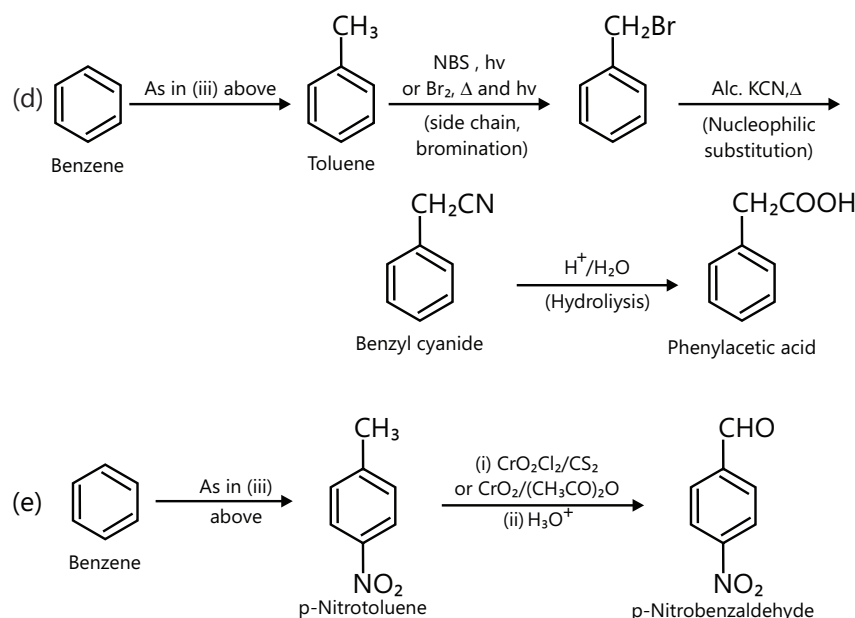
**Example 7:** How will you prepare the following compounds from benzene? You may use any inorganic reagent and any organic reagent having not more than one carbon atom.

- (a) Methyl benzoate      (b) m-Nitrobenzoic acid      (c) p-Nitrobenzoic acid  
 (d) phenyl acetic acid      (e) p-Nitrobenzaldehyde.

**Sol:**

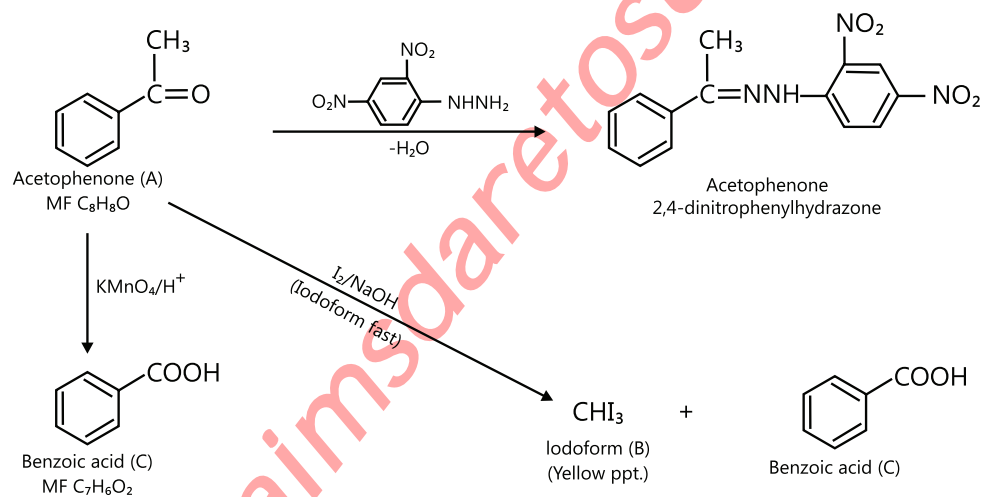






**Example 8:** An aromatic compound 'A' (Molecular formula  $C_8H_8O$ ) gives positive 2, 4-DNP test. It gives a yellow precipitate of compound 'B' on treatment with iodine and sodium hydroxide sol. Compound 'A' does not give Tollen's or Fehling's test. On drastic oxidation with potassium permanganate it forms a carboxylic acid 'C' (Molecular formula  $C_7H_6O_2$ ), which is also formed along with the yellow compound in the above reaction, Identify A, B and C and all the reaction involved.

**Sol:** (i) From the given data we can see that aromatic compound 'A' ( $MFC_8H_8O$ ) gives positive 2, 4-DNP test, thus it must be an aldehyde or a ketone.



(ii) As compound 'A' does not give Tollen's test or Fehling's test, thus 'A' must be a ketone.

(iii) Compound 'A' on treatment with  $I_2/NaOH$ , gives yellow precipitate of compound 'B' therefore, compound 'B' must be iodoform and the ketone 'A' must be a methyl Ketone (Haloform reaction)

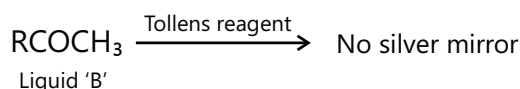
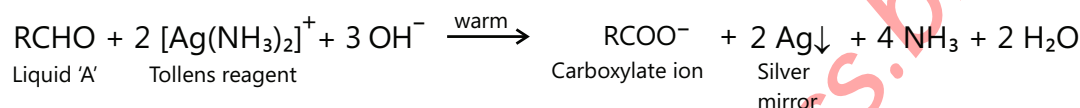
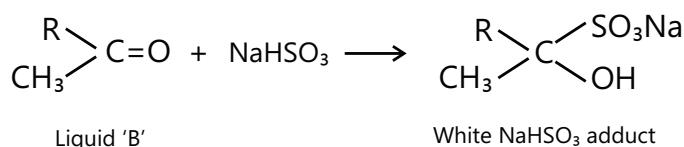
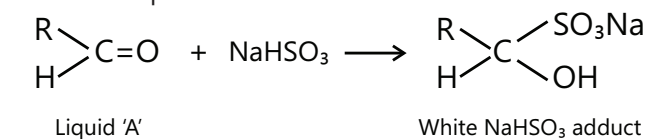
(iv) Since methyl ketone 'A' on drastic oxidation with  $KMnO_4$  gives a carboxylic acid 'C' ( $MFC_7H_6O_2$ ), therefore, 'C' must be benzoic acid and compound 'A' must be acetophenone ( $C_6H_5COCH_3$ ).

**Example 9:** When liquid 'A' is treated a freshly prepared ammonical silver nitrate sol, it gives bright silver mirror. The liquid forms a white crystalline solid on treatment with sodium hydrogensulphite. Liquid 'B' also forms a white crystalline solid with sodium hydrogensulphite but it does not give test with ammoniacal silver nitrate. Which of the two liquids is the aldehyde? Write the chemical equations of these reactions as well.

**Sol:** (i) As we can see, liquid 'A' forms a white crystalline solid on treatment with  $\text{NaHSO}_3$ , thus it may be an aldehyde or a methyl ketone. And also liquid 'A' forms a bright silver mirror on treatment with a freshly prepared ammoniacal Sol of  $\text{AgNO}_3$ . Therefore, liquid 'A' is an aldehyde. (Aldehyde gives positive silver mirror test)

(ii) On the other side, liquid 'B' forms a white crystalline solid on treatment with  $\text{NaHSO}_3$ , it may be an aldehyde or a methyl ketone. But liquid 'B' shows negative test with ammoniacal  $\text{AgNO}_3$  solution therefore, liquid 'B' must be a methyl ketone.

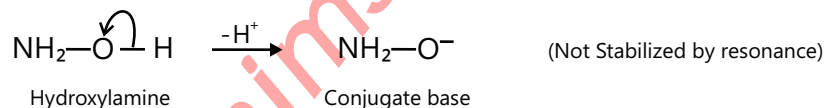
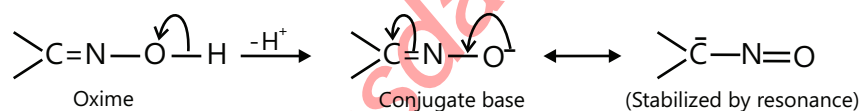
Chemical equations for the reactions discussed are



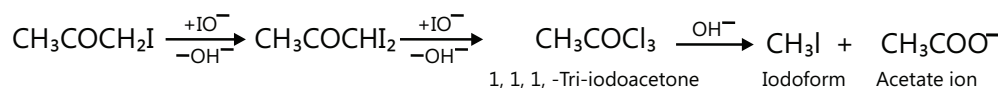
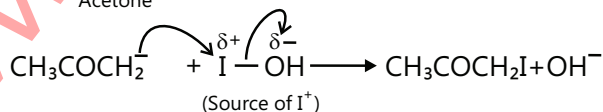
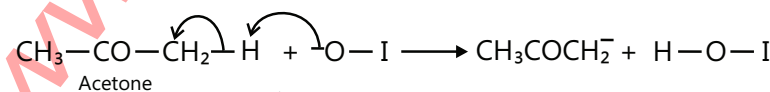
**Example 10:** Give reasons for the following:

- Oximes are more acidic than hydroxylamines
- Iodoform is obtained by the reaction of acetone with hypoiodite but not with the iodide ion.
- Oxidation of toluene to benzaldehyde with  $\text{CrO}_3$  is carried out in presence of acetic anhydride and not in presence of  $\text{H}_2\text{SO}_4$ .

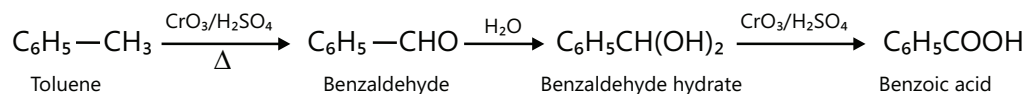
**Sol:** (a) In case of oxime, on proton loss it gives a conjugate base which is stabilized by resonance but the conjugate base of  $\text{NH}_2\text{OH}$  is not.



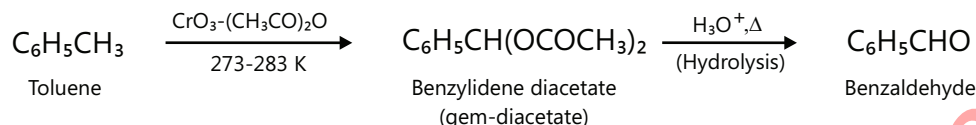
(b) During the course of reaction,  $\text{I}^+$  is required which is supplied by  $\text{IO}^-$  ion but not by  $\text{I}^-$  ion thus iodide ion is not used. The reaction is as shown below:



(c) This is because  $\text{CrO}_3/\text{H}_2\text{SO}_4$  is a powerful oxidizing agent. During the oxidation of toluene with  $\text{CrO}_3/\text{H}_2\text{SO}_4$  the intermediate benzaldehyde formed readily undergoes oxidation to form benzoic acid due to the presence of  $\text{H}_2\text{O}$  in  $\text{H}_2\text{SO}_4$ .

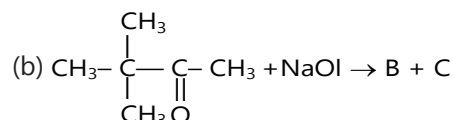
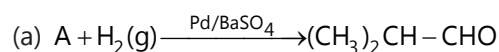


However, with  $\text{CrO}_3$  in  $(\text{CH}_3\text{CO})_2\text{O}$ , due to the absence of  $\text{H}_2\text{O}$  as soon as benzaldehyde is formed, it reacts with acetic anhydride to form benzylidene diacetate which does not undergo further oxidation. In this way, oxidation of benzaldehyde to benzoic acid is prevented. The gem-diacetate thus formed upon subsequent hydrolysis with alkali or acid gives benzaldehyde.



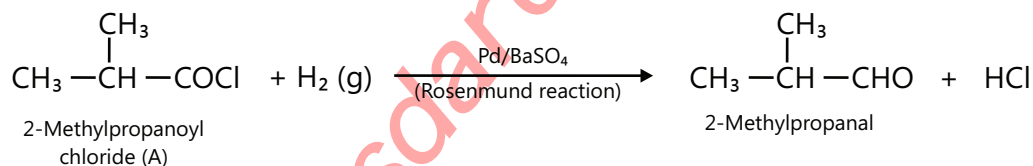
## JEE Advanced/Boards

**Example 1:** Complete the following reaction by identifying (A), (B) and (C).

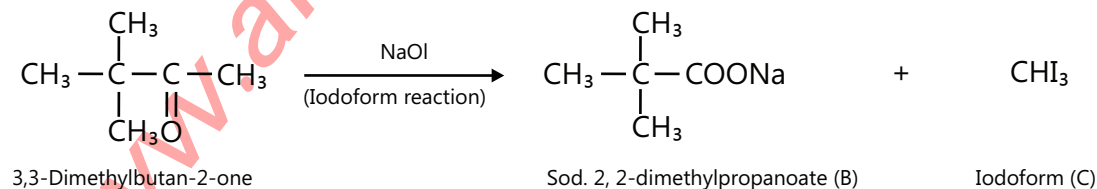


**Sol:** (a) This is a well-known Rosenmund reduction reaction. The catalyst used is palladium poisoned with  $\text{BaSO}_4$  supported on carbon.

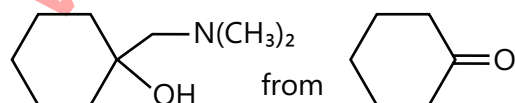
The reagent is specific and acts only upon acid chloride group. Since acid chlorides on Rosenmund reduction give aldehydes, therefore, compound (A) must be an acid chloride,  $(\text{CH}_3)_2\text{CH}-\text{COCl}$



(b) This is an example of an Iodoform reaction. A ketone containing methyl group undergoes this reaction. This method is used to identify methyl ketone specifically. Yellow precipitate of Iodoform confirms the presence of a methyl group. Methyl ketone on oxidation with  $\text{NaOI}$  ( $\text{I}_2 + \text{NaOH}$ ) gives iodoform and the sodium salt of the acid. Thus,



**Example 2:** Suggest a sequence of reactions to carry out the following transformation, but one intermediate must be an alkene.



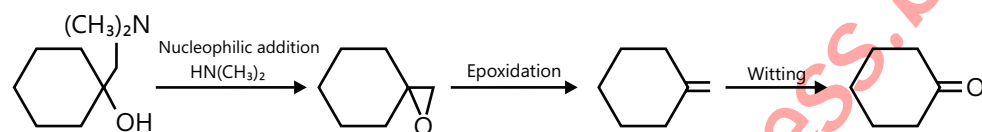
**Sol:** Here we can apply new approach for the following transformation. i.e Retrosynthesis. This is achieved by transforming a target molecule into simpler precursor structures without assumptions regarding starting materials.

There are many alkene reactions, so this is really not a significant restriction. The starting compound ketone suggests that a Wittig route might be possible

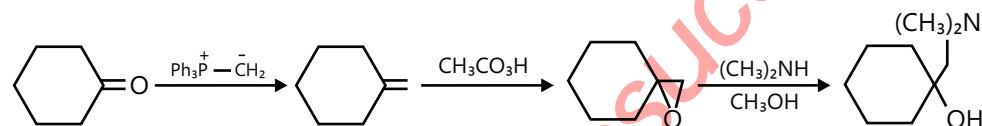
Retro synthesis:

1. First locate the Bond which has been broken to form the end product.
2. Presence of two alkyl group and OH outside the Cyclohexane shows that it must be an Epoxy group.
3. Nucleophilic addition of  $(\text{CH}_3)_2\text{NH}$  opens up the ring.
4. Now we all know Epoxide is formed from a double bond so there must be a double bond outside the cyclohexane ring. (We have satisfied the demand of the question that transformation should contain one alkene intermediate.)
5. As our starting material is a carbonyl group we can easily convert it into an alkene by a well-known Wittig reaction.
6. The Retrosynthetic approach for the above transformation can be written in form of reaction as follows:

Retrosynthesis:



Forward direction:



**Example 3:** Explain:

(a)  $\alpha$ -Halocarbonyl compounds, even the  $3^\circ$  types like  $\left( \begin{matrix} \text{R} \\ | \\ \text{R}-\text{C}-\text{CHO} \\ | \\ \text{Cl} \end{matrix} \right)$ , do not undergo  $\text{S}_{\text{N}}1$  reaction.

(b) Which is more reactive: (i)  $\text{PrCl}$  or (ii)  $\text{MeCOCH}_2\text{Cl}$  with  $\text{NaI}$ /acetone?

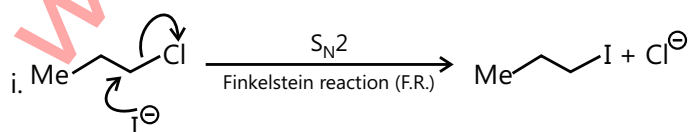
(c) Acetals and ketals are regenerated back to carbonyl, compounds with  $\text{H}_3\text{O}^{\oplus}$  but not with  $\text{OH}^-$ .

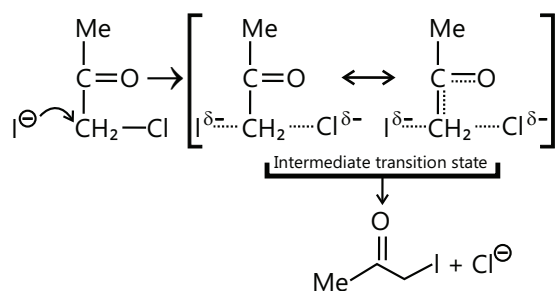
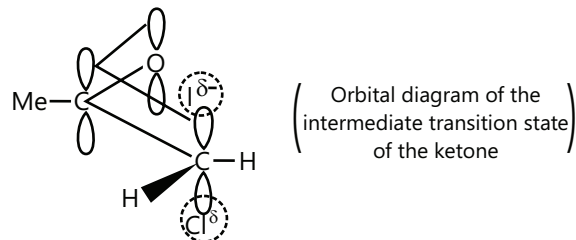
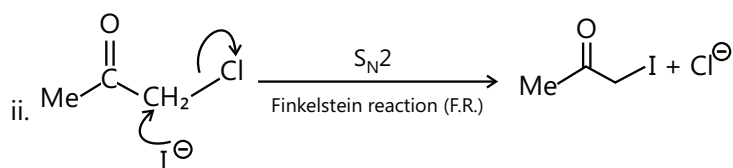
(d) Cyclohexanone is more reactive than cyclopentanone with  $\text{HCN}$ .

**Sol:** (a)  $\text{S}_{\text{N}}1$  reaction involves formation of Carbocation, although it contains adjacent two alkyl group the carbocation formed is unstable this is because of the presence of positive charges on adjacent C atoms. (Electron withdrawing effect of chlorine makes two alkyl group slightly electron deficient)

(b) Both are Primary alkyl halide and undergo  $\text{S}_{\text{N}}2$  (Substitution nucleophilic bimolecular) reaction. Order of reactivity is (ii)  $\gg$  (i).

The high reactivity of (ii) in  $\text{S}_{\text{N}}2$  reaction is due to the stabilizing effect produced in the transition state of ketone by the overlap of adjacent  $\pi$ -bond with the p-orbital of the  $\text{sp}^2$ -hybridised C atom. This type of overlap is also responsible for the high reactivity of halides in  $\text{S}_{\text{N}}2$  reaction.

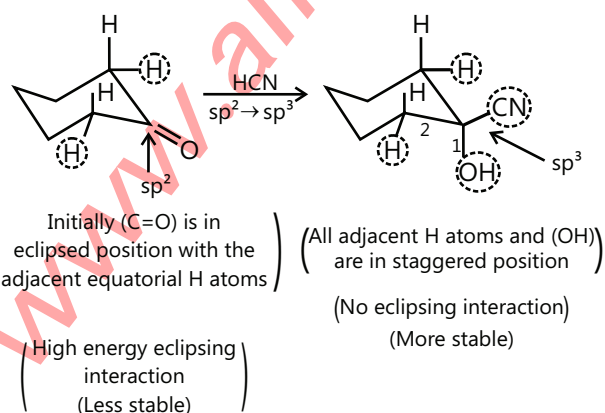
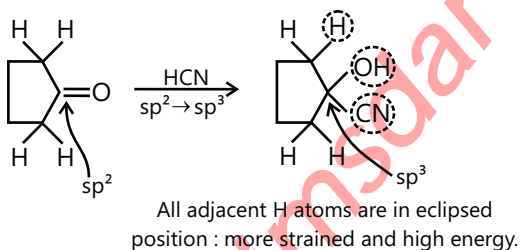




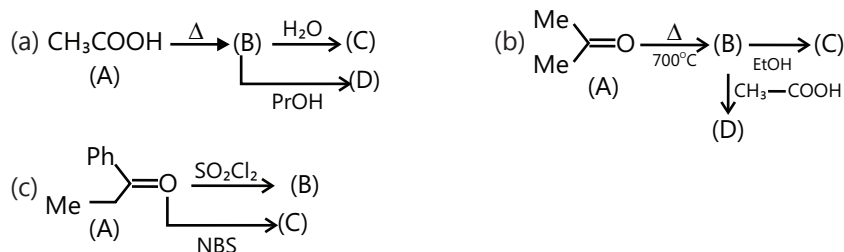
(c) The formation of hemiacetal or half hydrate takes place in acid only.  $\text{OH}^-$  is a weaker base than  $\text{OR}^-$ . It's not possible in base because a weaker base ( $\text{OH}^-$ ) cannot displace stronger base ( $\text{RO}^-$ ). But the formation of acetal from hemiacetal can take place by both acid and base. So the reverse process of hemiacetal to ( $\text{C}=\text{O}$ ) compound can occur only with acid but not with base.

(d) (i) Cyclopentanone suffers from ring strain. In Cyclopentanone, the hybridization of C atom of ( $\text{C}=\text{O}$ ) group changes from  $\text{sp}^2 \rightarrow \text{sp}^3$ , and the adjacent hydrogen atoms are in eclipsed position which increases the strain due to eclipsing interaction.

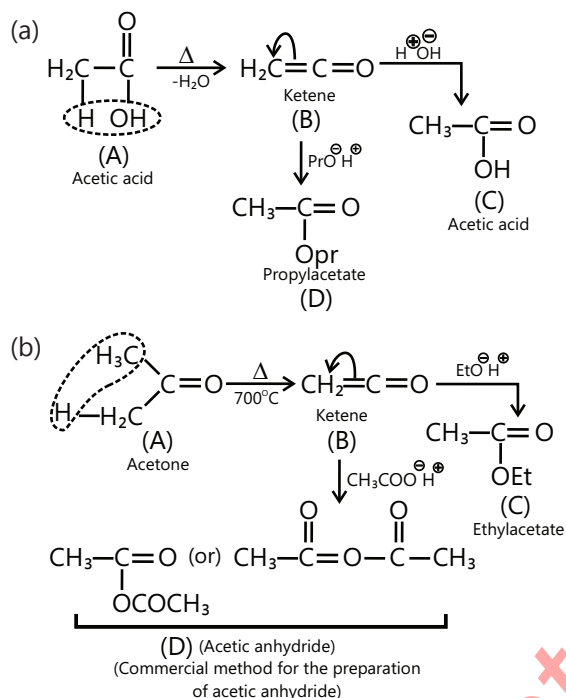
(ii) In cyclohexanone, the hybridization of C atom of ( $\text{C}=\text{O}$ ) group changes from  $\text{sp}^2 \rightarrow \text{sp}^3$ , the ring is free from strain and after nucleophilic addition, all the adjacent H and OH atoms are in staggered position hence destabilization effect is lost as there no eclipsing interaction.



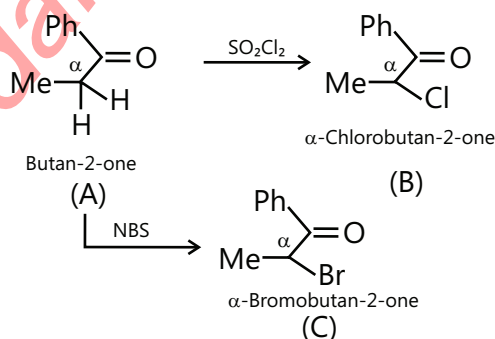
**Example 4:** Complete the following reaction



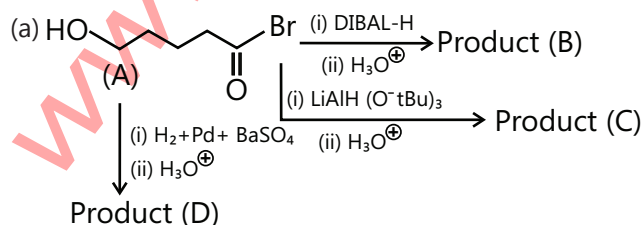
**Sol:** The formation of (B) in both (a) and (b) is industrial method for the preparation of ketone.



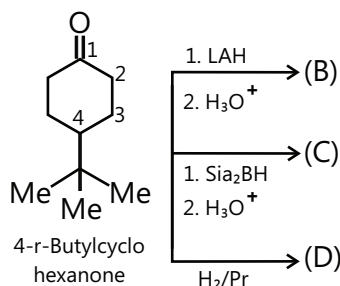
(c) Halogenation occurs at the  $\alpha$ -position of the (C=O) group, via free radical mechanism. NBS (N-Bromosuccinimide) is commonly used brominating agent.



**Example 5:** Complete the following reactions:



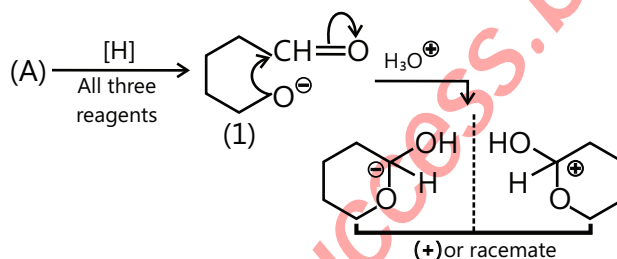
(b) Give the major products of the following



**Sol:** (a) After looking at the question you will notice that all the three reagents, namely, DIBAL-H,  $\text{LiAlH}(\text{O}-t\text{-Bu})_3$ , and  $(\text{H}_2 + \text{Pd} + \text{BaSO}_4)$  (Rosenmund reduction) are reducing agents.

Thus they will reduce the acid halides to aldehydes.

The products (B), (C), and (D) are same Hydroxyl aldehydes than undergo intramolecular reaction to give cyclic hemiacetal. On reduction with all three reagents give (I) Hydroxylaldehyde anion, which undergoes ring closure. A chiral center is formed during the ring closure reaction and as a result, two enantiomer forms are obtained and the product is a racemic mixture. (Optically inactive)

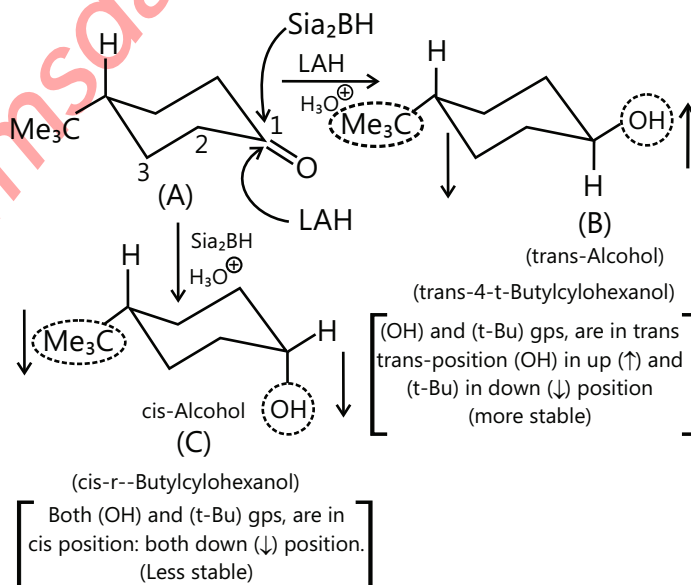


(b) Bulky-1-butyl group always occupies less hindered equatorial in cyclohexane.

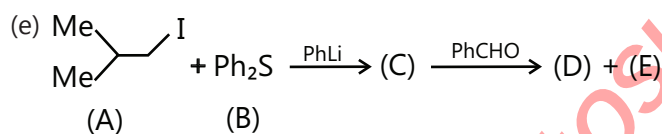
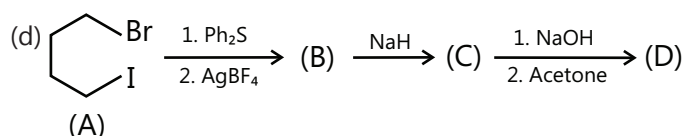
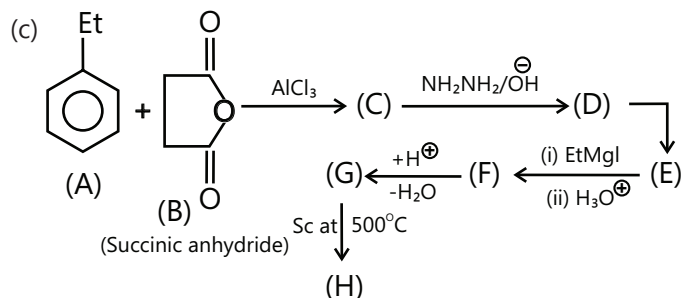
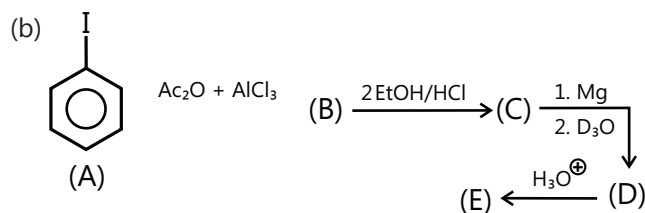
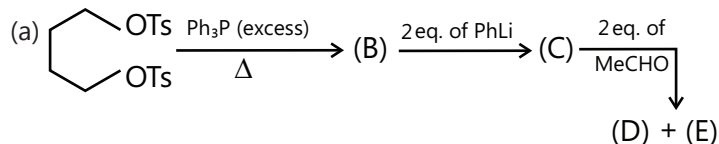
(i)  $\text{Si}_2\text{BH}$  is a bulky group. Thus it approaches  $(\text{C}=\text{O})$  from the less hindered equatorial side, pushing  $(\text{OH})$  to axial position which result in the formation of less stable cis-isomer.

(ii) Less bulky LAH approaches  $(\text{C}=\text{O})$  from the more hindered axial side, pushing  $(\text{OH})$  to equatorial position. Resulting in the more stable trans-isomer.

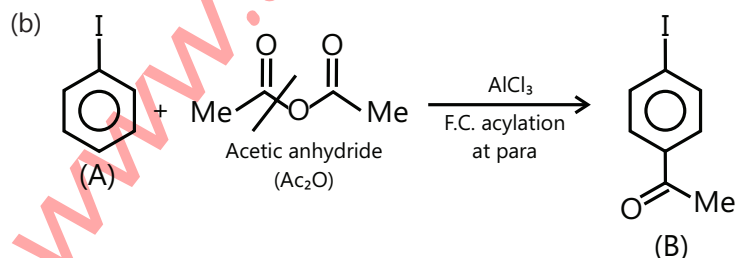
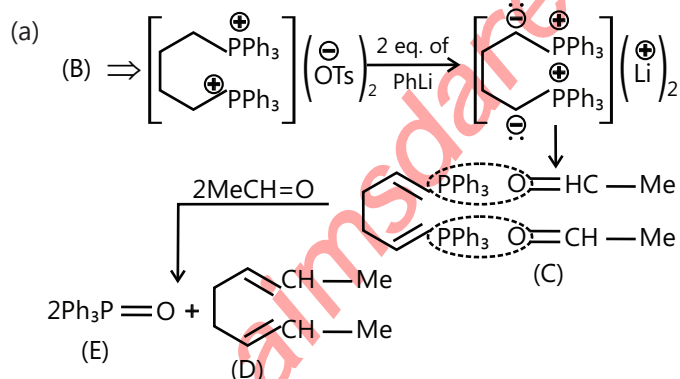
(iii) With  $\text{H}_2 + \text{Pt}$ : Cis-alcohol is formed in major amount, because  $\text{H}_2$  is adsorbed on the surface of a finely divided catalyst, and H approaches from the less hindered equatorial side and gives cis-alcohol as in (i)



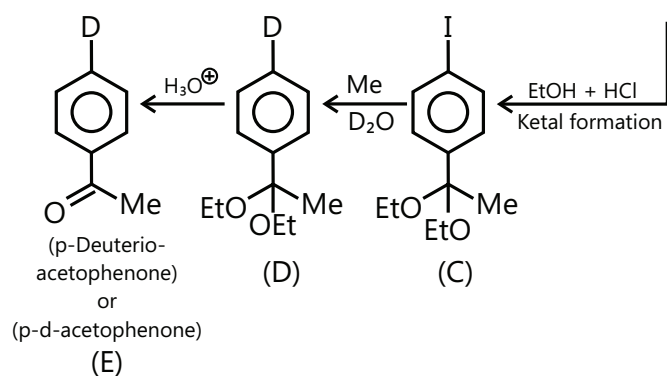
**Example 6:** Complete the following reactions:



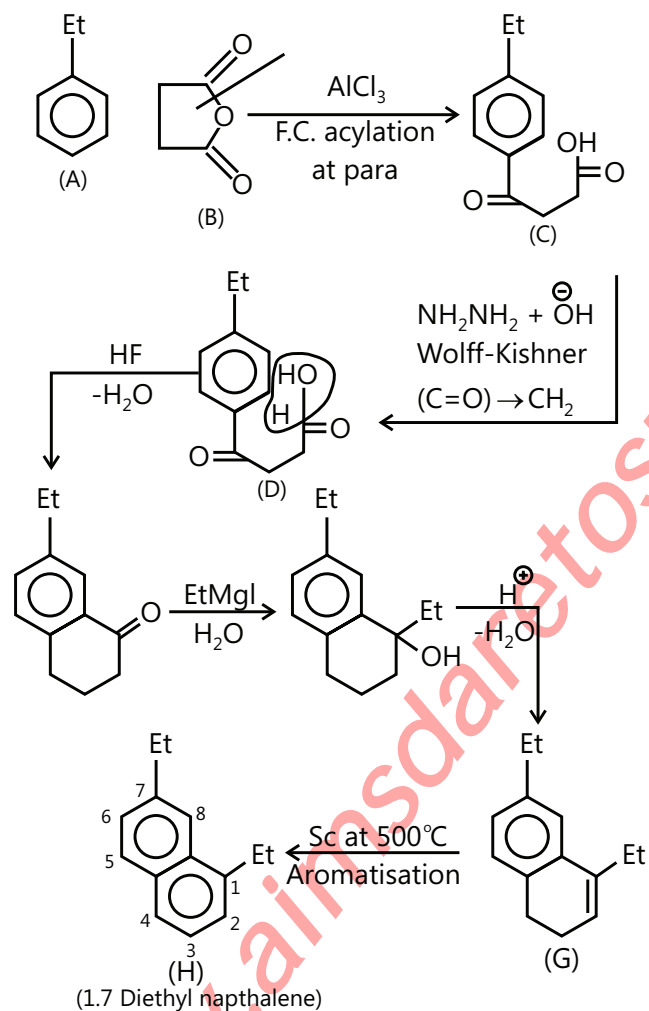
**Sol:**



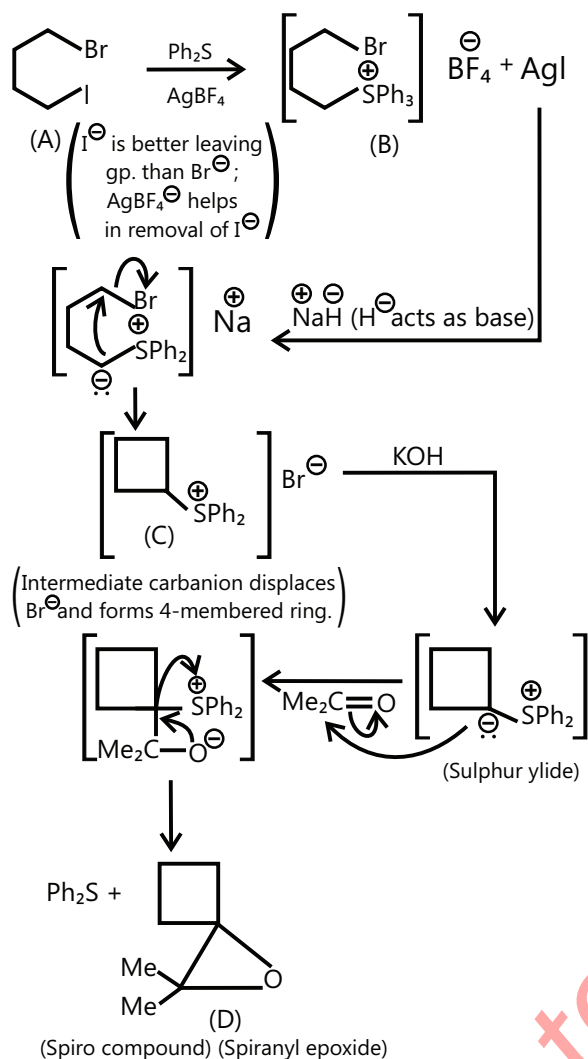




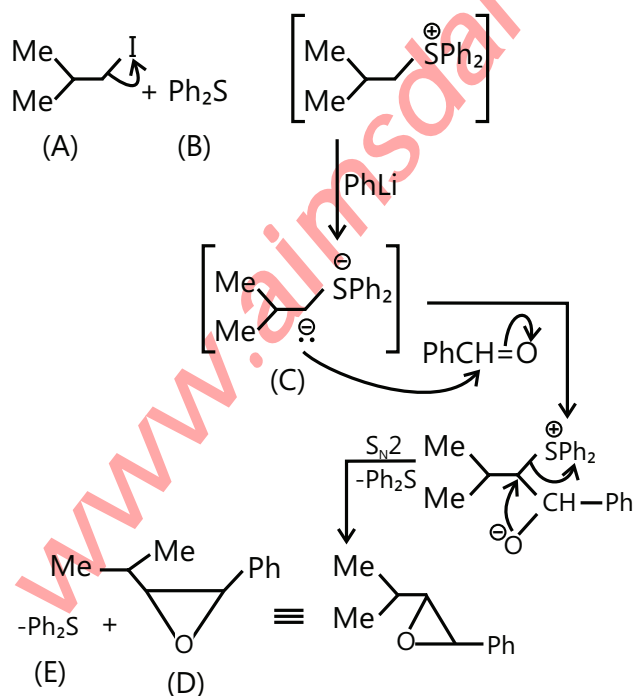
(c) First step is Friedal craft acylation that takes place at para position followed by Wolf kishner reduction. Further steps involved are Grignard reaction and aromatization.



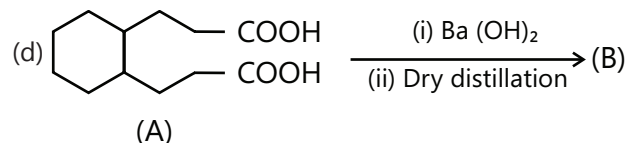
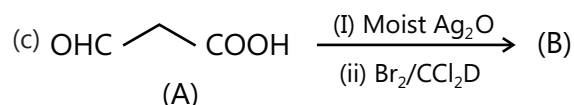
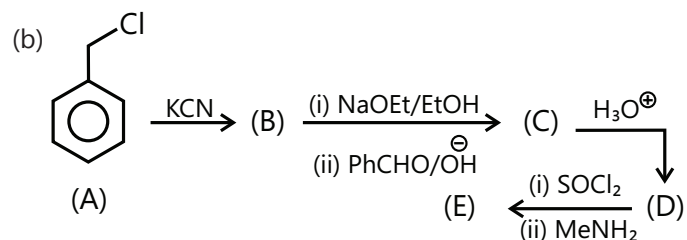
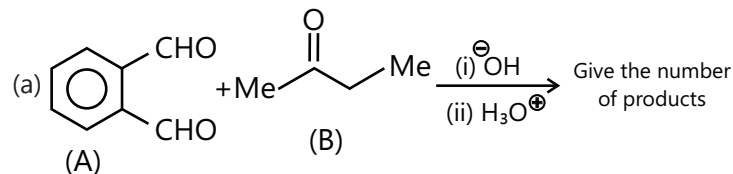
(d) It is a Wittig type reaction and proceeds via-sulphur ylide. Dihalide compound is treated with  $\text{Ph}_2\text{S}$  in  $\text{AgBF}_4$  Followed by the treatment with a strong base to form Wittig reagent. Now this Wittig reagent when treated with  $\text{KOH}$  forms sulphurylide which reacts with carbonyl compound to form a Spiro compound.



(e) It is a Wittig type reaction and proceeds via sulphur ylide, the product formed is a substituted epoxide ring.



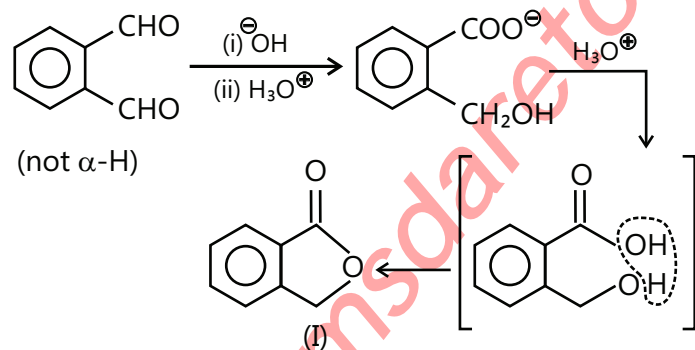
**Example 7:** Complete the following reactions:



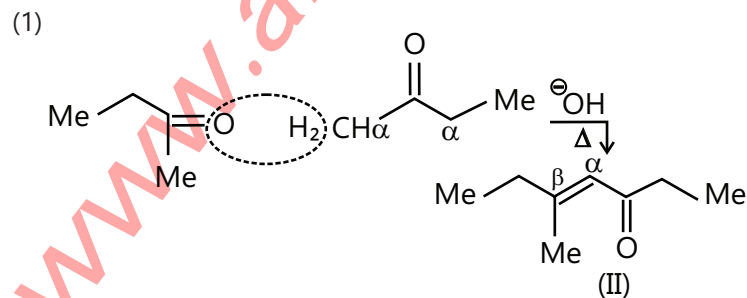
**Sol:** (a) In this reaction, 4 products are possible.

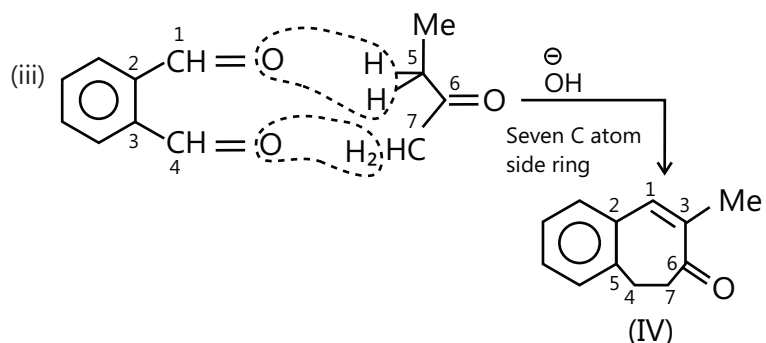
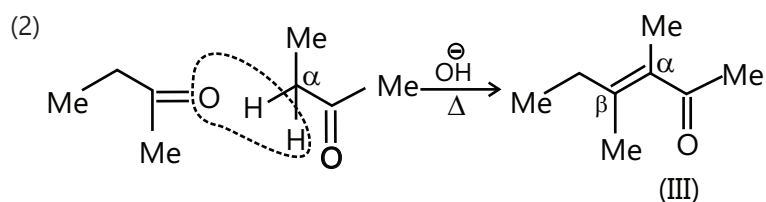
First of all it can undergo intermolecular Cannizzaro reactions. Other is it can undergo aldol condensation here 2 products are formed. And third is Claisen Schmidt reaction (Reaction between A and B)

(i) Intramolecular Cannizzaro reaction of (A):



(ii) Aldol condensation of (B)





( Numbering in accordance with problem understanding )

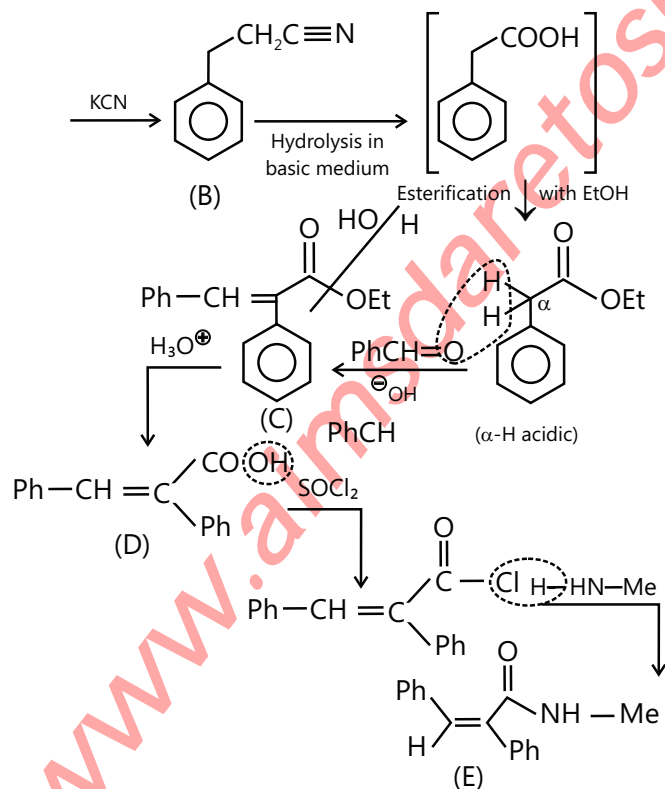
(b) (i) First step is nucleophilic substitution.

(ii) Second step is hydrolysis, thus acid is formed (CN $\rightarrow$ COOH)

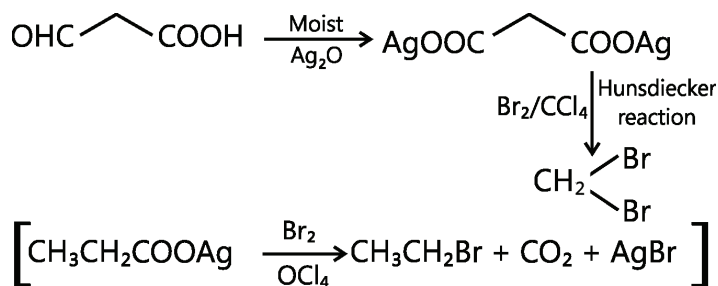
(iii) Third step is esterification using ethanol (COOH $\rightarrow$ COOC<sub>2</sub>H<sub>5</sub>) (protection of acid group)

(iv) Fourth step is Knoevenagel Condensation, product obtained is hydrolyzed to obtain acid group. (Deprotection)

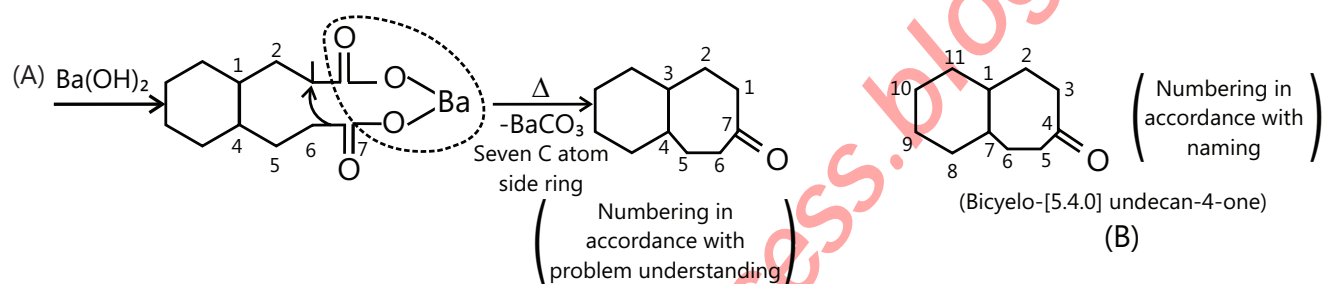
(v) Reaction with SOCl<sub>2</sub> produces acid chloride group which on treatment with methyl amine gives the product.



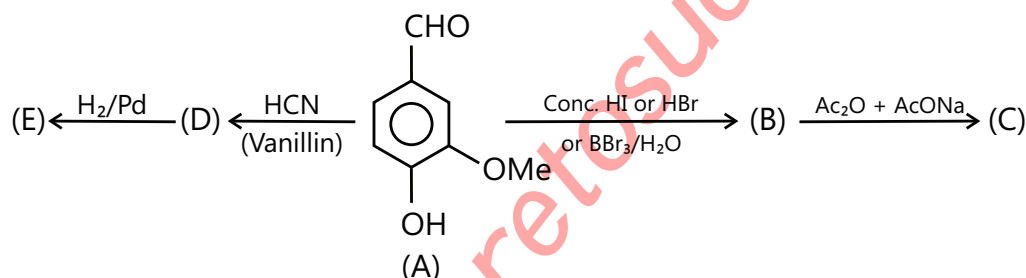
(c) Moist  $\text{Ag}_2\text{O}$  gives  $\text{AgOH}$  which acts as an oxidising agent and oxidises  $(-\text{CHO})$  group to  $(-\text{COOAg})$ ; the  $(\text{COOH})$  group also change to  $(-\text{COOAg})$ , which then undergoes Hunsdiecker reaction.



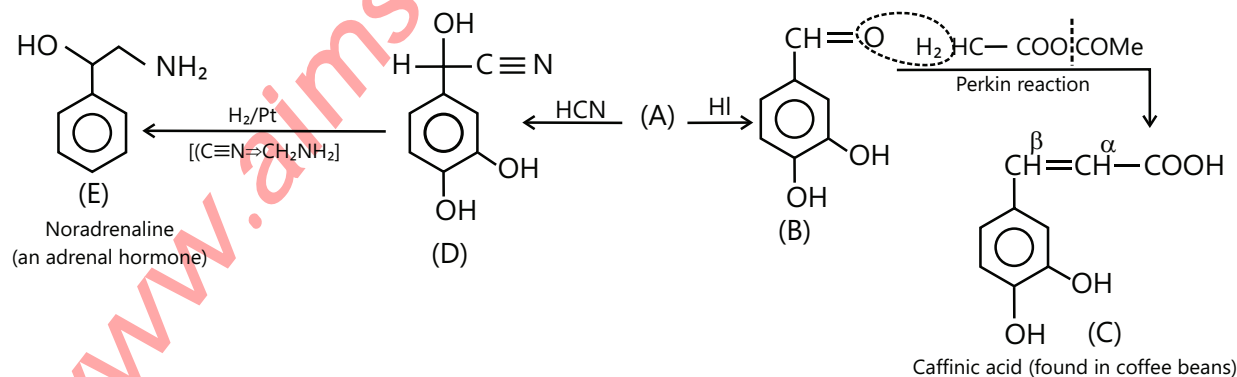
(d) First step is a simple acid base neutralization reaction forming a salt of Ba which on heating gives off  $\text{BaCO}_3$  and bicyclic ketone as a final product.

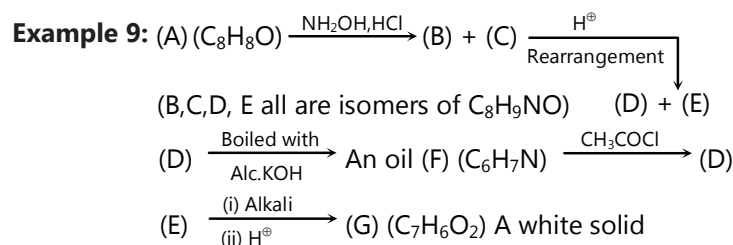


**Example 8:** Complete the following reaction:

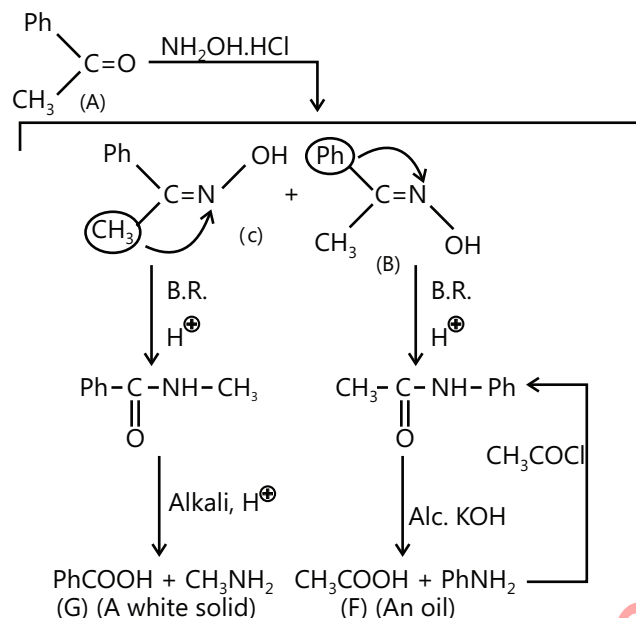


**Sol:**



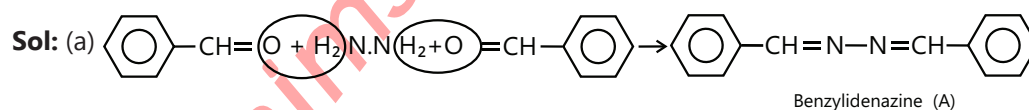


**Sol:** Degree of unsaturation =  $5^\circ$  (aromatic and ketone), i.e. Beckmann rearrangement

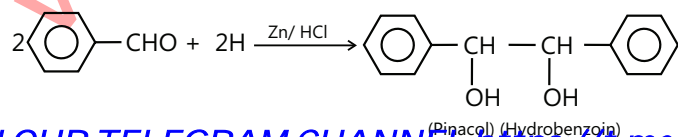


**Example 10:** Complete the following:

- $2PhCHO + NH_2NH_2 \rightarrow$
- Reduction of PhCHO with the following
  - Tollens reagent
  - Zn/HCl
  - LAH
  - Clemmensen's reduction (Zn (Hg)/conc. HCl)
- Wolff-Kishner reduction ( $NH_2NH_2 + Glycol + \bar{O}H$ ) vi. Two moles of PhCHO with Zn+HCl



- (i) with Tollen's reagent, it will form PhCOOH
- Zn/HCl is a reducing agent so it will reduce the aldehyde in to primary alcohol, i.e. PhCH<sub>2</sub>OH
- LAH is also a reducing agent thus it will form the same product, i.e. PhCH<sub>2</sub>OH
- and (v) Wolf kishner reduction and Clemmensen's reduction-It will reduce the carbonyl group (CHO  $\rightarrow$  CH<sub>2</sub>)  
 Thus hydrocarbon will be formed. i.e PhCH<sub>3</sub>
- A pinacol will be formed.



## JEE Main/Boards

### Exercise 1

**Q.1** Explain Knoevenagel Reaction with mechanism?

**Q.2** Which of the following compounds would undergo aldol condensation, which the Cannizzaro reaction and which neither? Write the structures of the expected products of aldol condensation and Cannizzaro reaction.

- |                          |                        |
|--------------------------|------------------------|
| (i) Methanal             | (ii) 2-Methylpentanal  |
| (iii) Benzaldehyde       | (iv) Benzophenone      |
| (v) Cyclohexanone        | (vi) 1-Phenylpropanone |
| (vii) Phenylacetaldehyde |                        |
| (viii) Butan-1-ol        |                        |
| (ix) 2,2-Dimethylbutanal |                        |

**Q.3** How will you convert ethanal into the following compounds?

- (i) Butane-1, 3-diol      (ii) But-2-enal  
(iii) But-2-enoic acid

**Q.4** Write structural formulas and names of four possible aldol condensation products from propanal and butanal. In each case, indicate which aldehyde acts as nucleophile and which as electrophile.

**Q.5** An organic compound with the molecular formula  $C_9H_{10}O$  forms 2, 4-DNP derivative, reduces Tollens' reagent and undergoes Cannizzaro reaction. On vigorous oxidation, it gives 1, 2-benzenedicarboxylic acid. Identify the compound.

**Q.6** Describe the following reactions

- (i) Cannizzaro's reaction  
(ii) Cross aldol reaction

**Q.7** Give chemical tests to distinguish between

- (i) Acetaldehyde and Benzaldehyde  
(ii) Propanone and propanol.

**Q.8** Write the names of the reagents and equations in the conversion of

- (i) Phenol to salicylaldehyde.  
(ii) Anisole to p-methoxyacetophenone.

**Q.9** Write one chemical reaction each to exemplify the following

- (i) Rosenmund reduction      (ii) Tollens' reagent

**Q.10** Explain Pinacole-Pinacolone Rearrangement?

**Q.11** Write reactions for obtaining

- (i) Acetone from acetic acid.  
(ii) Benzene from toluene.

**Q.12** a) How will you obtain an aldehyde by using following process

- (i) Dehydrogenation      (ii) Catalytic hydrogenation?  
b) (i) Why do aldehydes behave like polar compounds?  
(ii) Why do aldehydes have lower boiling point than corresponding alcohols?

**Q.13** Explain Wittig reaction with mechanism?

**Q.14** Convert:

- (i) Acetaldehyde to Acetone  
(ii) Acetone to Acetylene

**Q.15** An organic compound (A) (molecular formula  $C_8H_{16}O_2$ ) was hydrolysed with dilute sulphuric acid to give a carboxylic acid (B) and an alcohol (C). Oxidation of (C) with chromic acid produced (B). (C) on dehydration gives but-1-ene. Write equations for the reactions involved.

**Q.16** Give simple chemical tests to distinguish between the following pairs of compounds.

- (i) Propanol and Propanone  
(ii) Acetophenone and Benzophenone  
(iii) Phenol and Benzoic acid

**Q.17** How will you bring about the following conversions in not more than two steps?

- Propanone to Propene
- Ethanol to 3-Hydroxybutanal
- Benzaldehyde to Benzophenone

**Q.18** Give possible explanation for each of the following:

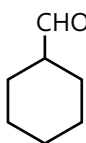

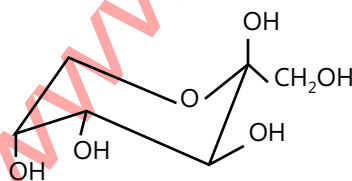
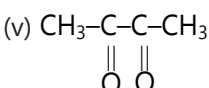
- Cyclohexanone forms cyanohydrin in good yield but 2, 2, 6-trimethylcyclohexanone does not.
- There are two -NH<sub>2</sub> groups in semicarbazide. However, only one is involved in the formation of semicarbazones.
- During the preparation of esters from a carboxylic acid and an alcohol in the presence of an acid catalyst, the water or the ester should be removed as soon as it is formed.

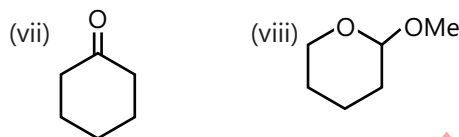
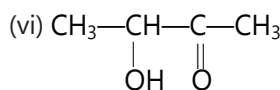
**Q.19** An organic compound contains 69.77% carbon, 11.63% hydrogen and rest oxygen. The molecular mass of the compound is 86. It does not reduce Tollens' reagent but forms an addition compound with sodium hydrogensulphite and give positive iodoform test. On vigorous oxidation it gives ethanoic and propanoic acid. Write the possible structure of the compound.

**Q.20** Write the difference between aldol condensation and cannizzaro reaction.

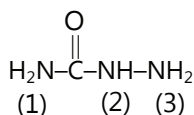
**Q.21** A compound with molecular formula C<sub>8</sub>H<sub>18</sub>O<sub>4</sub> does not give litmus test and does not give color with 2, 4-DNP. It reacts with excess MeCOCl to give a compound whose vapour density is 131. Compound A contains how many hydroxy groups?

**Q.22** Which of the following compounds will give Fehling's test positive?

- 
- 
- 
- HCOOH
- 

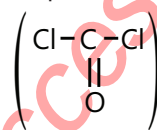


**Q.23** Which of the amino group in semi carbazide will react with Ph-CH = O carbonyl group?



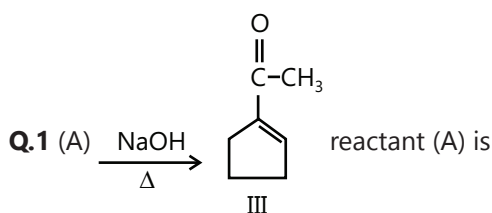
**Q.24** How many organic products are formed in good amount in above reaction?

**Q.25** How many molecules of MeMgCl will be consumed for per molecule of phosgene



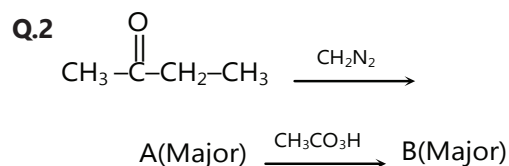
## Exercise 2

### Single Correct Choice Type



- $\text{CH}_3-\overset{\text{O}}{\parallel}{\text{C}}-(\text{CH}_2)_5-\overset{\text{O}}{\parallel}{\text{C}}-\text{CH}_3$
- $\text{CH}_3-\overset{\text{O}}{\parallel}{\text{C}}-(\text{CH}_2)_4-\overset{\text{O}}{\parallel}{\text{C}}-\text{H}$
- $\text{H}-\overset{\text{O}}{\parallel}{\text{C}}-(\text{CH}_2)_5-\overset{\text{O}}{\parallel}{\text{C}}-\text{H}$
- $\text{CH}_3-\overset{\text{O}}{\parallel}{\text{C}}-(\text{CH}_2)_4-\text{CH}_2-\text{OH}$

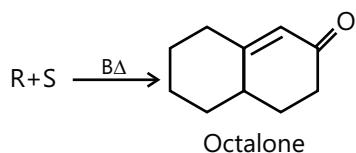




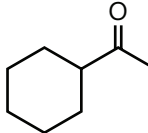
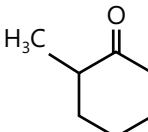
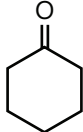
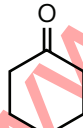
Product B is

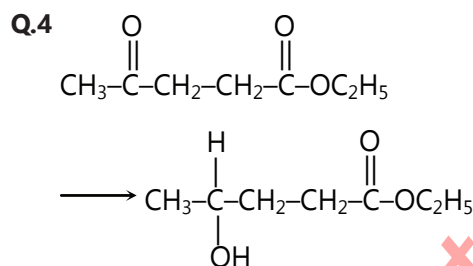
- (A)  $\text{CH}_3-\text{O}-\overset{\text{O}}{\parallel}{\text{C}}-\text{CH}_2-\text{CH}_2-\text{CH}_3$
- (B)  $\text{CH}_3-\overset{\text{O}}{\parallel}{\text{C}}-\text{O}-\text{CH}_2-\text{CH}_2-\text{CH}_3$
- (C)  $\text{CH}_3-\text{CH}_2-\overset{\text{O}}{\parallel}{\text{C}}-\text{O}-\text{CH}_2-\text{CH}_3$
- (D)  $\text{CH}_3-\overset{\text{O}}{\parallel}{\text{C}}-\text{O}-\text{CH}_2-\text{CH}_3$

**Q.3** The product Octalone is obtained by Michael addition followed by aldol condensation of reactants R and S in presence of a base. S gives positive iodoform test.



R and S respectively.

- (A)  +  $\text{CH}_3-\text{CH}=\text{O}$
- (B)  +  $\text{CH}_2=\text{CH}-\overset{\text{O}}{\parallel}{\text{C}}-\text{H}$
- (C)  +  $\text{CH}_2=\text{CH}-\overset{\text{O}}{\parallel}{\text{C}}-\text{CH}_3$
- (D)  +  $\text{CH}_3=\text{CH}_2-\overset{\text{O}}{\parallel}{\text{C}}-\text{CH}_3$

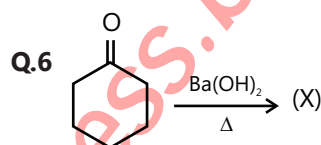


The conversion is carried out by using which of the following

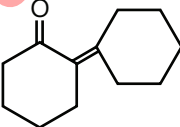
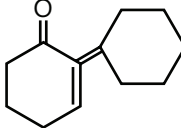
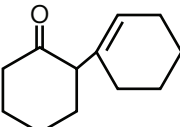
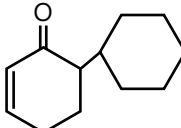
- (A)  $\text{NaBH}_4$  (B)  $\text{LiAlH}_4$  (C)  $\text{Pd}/\text{H}_2$  (D)  $\text{Na-EtOH}$

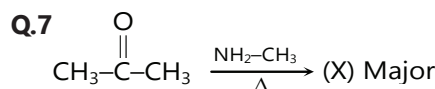
**Q.5** Which of the following compounds can undergo aldol condensation.

- (A)  $\text{Me}_3\text{C-CHO}$  (B)  $\text{PhCHO}$   
 (C)  $\text{MeCHO}$  (D)  $\text{HCHO}$



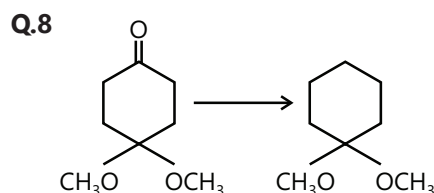
Major product (X) is

- (A)  (B) 
- (C)  (D) 



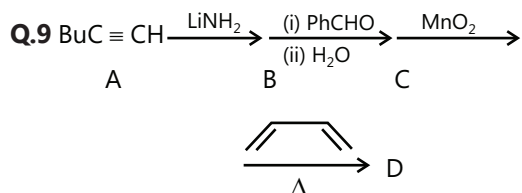
Major product (X) is

- (A)  $\text{CH}_3-\overset{\text{NH}=\text{CH}_2}{\text{CH}}-\text{CH}_3$  (B)  $\text{CH}_3-\overset{\text{NH}}{\parallel}{\text{C}}-\text{CH}_3$   
 (C)  $\text{CH}_3-\overset{\text{N-CH}_3}{\parallel}{\text{C}}-\text{CH}_3$  (D)  $\text{CH}_3-\overset{\text{NH-CH}_3}{\text{CH}}-\text{CH}_3$



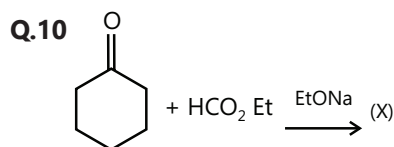
Conversion can be achieved by

- (A) Clemmenson reduction
- (B) Wolf-Kishner reduction
- (C) Pd/BaSO<sub>4</sub>
- (D) Sn/HCl



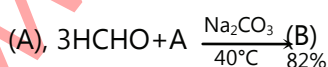
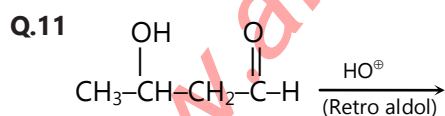
Compound D of the above reaction is -

- (A)
- (B)
- (C)
- (D)



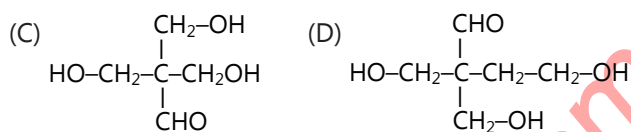
Identify unknown (X) in

- (A)
- (B)
- (C)
- (D)



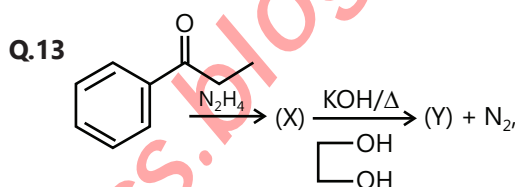
Product (B) of above reaction is -

- (A)
- (B)



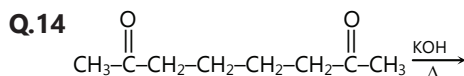
**Q.12** Principal product of following reaction is isolated in form of  $\text{CH}_2=\text{C}=\text{O} + \text{H}_2\text{S} \rightarrow ?$

- (A)
- (B)
- (C)
- (D)



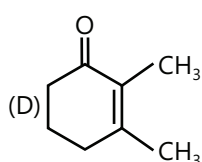
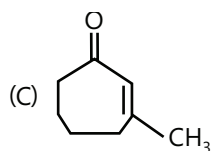
the structures of (X) and (Y) are-

- (A)
- (B)
- (C)
- (D)

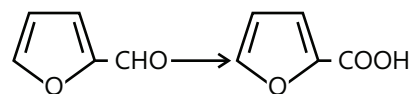


Possible products are-

- (A)
- (B)

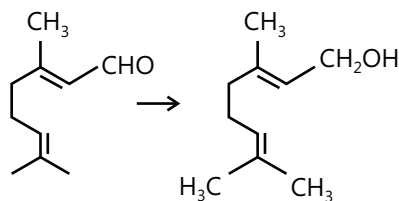


**Q.15** The given reaction can not be performed by the use of which of the following reagents?



- (A)  $\text{KMnO}_4/\text{H}_2\text{SO}_4$  (B)  $\text{K}_2\text{Cr}_2\text{O}_7/\text{H}_2\text{SO}_4$   
(C)  $\text{Ag}_2\text{O}/\text{NaOH}$  (D)  $\text{LiAlH}_4$

**Q.16** Citral can be converted into geraniol by the use of



Which reagent

- (A)  $\text{H}_2/\text{Pd}-\text{C}$  (B)  $\text{LiAlH}_4$   
(C)  $\text{H}_2/\text{Pd}-\text{BaSO}_4-\text{CaCO}_3$  (D)  $\text{NaBH}_4$

### Previous Years' Questions

**Q.1** Which of the following on heating with aqueous KOH produces acetaldehyde (2009)

- (A)  $\text{CH}_3\text{COCl}$  (B)  $\text{CH}_3\text{CH}_2\text{Cl}$   
(C)  $\text{CH}_2\text{ClCH}_2\text{Cl}$  (D)  $\text{CH}_3\text{CHCl}_2$

**Q.2** Ozonolysis of an organic compound gives formaldehyde as one of the products. This confirms the presence of (2011)

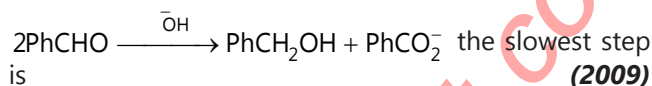
- (A) Two ethylenic double bonds  
(B) A vinyl group  
(C) An isopropyl group  
(D) An acetylenic triple bond

**Q.3** Trichloroacetaldehyde was subjected Cannizzaro's reaction by using NaOH. The mixture of the products contains sodium trichloroacetate ion and another compound. The other compound is (2001)

- (A) 2,2, 2-Trichloroethanol  
(B) Trichloromethanol

- (C) 2,2, 2-Trichloropropanol  
(D) Chloroform

**Q.4** In Cannizzaro reaction given below



- (A) The attack of at the carboxyl group  
(B) The transfer of hydride to the carboxylic group  
(C) The abstraction of proton from the carboxylic group  
(D) The deprotonation of  $\text{PhCH}_2\text{OH}$

**Q.5** A mixture of benzaldehyde and formaldehyde on heating with aqueous NaOH solution gives (2001)

- (A) Benzyl alcohol and sodium formate  
(B) Sodium benzoate and methyl alcohol  
(C) Sodium benzoate and sodium formate  
(D) Benzyl alcohol and methyl alcohol

**Q.6** Which one of the following undergoes reaction with 50% sodium hydroxide solution to give the corresponding alcohol and acid (2007)

- (A) Butanal (B) Benzaldehyde  
(C) Phenol (D) Benzoic acid

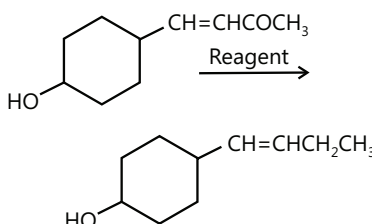
**Q.7** The increasing order of the rate of HCN addition to compounds A-D is (2006)

- (a) HCHO (b)  $\text{CH}_3\text{COCH}_3$  (c)  $\text{PhCOCH}_3$  (d)  $\text{PhCOPh}$   
(A)  $a < b < c < d$  (B)  $d < b < c < a$   
(C)  $d < c < b < a$  (D)  $c < d < b < a$

**Q.8** The pair of compounds in which both the compounds give positive test with Tollen's reagent is (2004)

- (A) Glucose and Sucrose  
(B) Fructose and Sucrose  
(C) Acetophenone and Hexanal  
(D) Glucose and fructose

**Q.9** In the given transformation which the following is the most appropriate reagent (2012)

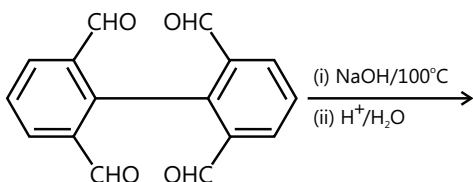


- (A)  $\text{NH}_2\text{NH}_2 \cdot \bar{\text{O}}\text{H}$       (B)  $\text{Zn-Hg/HCl}$   
 (C)  $\text{Na, Liq, NH}_3$       (D)  $\text{NaBH}_4$

**Q.10** Compound 'A' (molecular formula  $\text{C}_3\text{H}_5\text{O}$ ) is treated with acidified potassium dichromate to form a product 'B' (molecular formula  $\text{C}_3\text{H}_6\text{O}$ ). 'B' forms a shining silver mirror on warming with ammonical silver nitrate. 'B' when treated with an aqueous Sol: of  $\text{H}_2\text{NCONHNH}_2$ ,  $\text{HCl}$  and sodium acetate gives a product 'C'. Identify the structure of 'C' **(2002)**

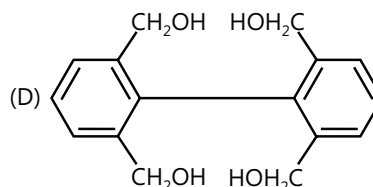
- (A)  $\text{CH}_3\text{CH}_2\text{CH} = \text{NNHCONH}_2$   
 (B)  $\text{CH}_3\text{CH} = \text{NNHCONH}_2$   
           |  
            $\text{CH}_3$   
 (C)  $\text{CH}_3\text{CH} = \text{NCONHNH}_2$   
           |  
            $\text{CH}_3$   
 (D)  $\text{CH}_3\text{CH}_2\text{CH-NCONHNH}_2$

**Q.11**

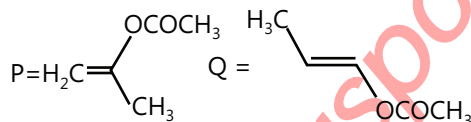


Major product is.

- (A)
- (B)
- (C)



**Q.12** The product of acid hydrolysis of P and Q can be distinguished by **(2003)**



- (A) Lucas Reagent      (B) 2, 4-DNP  
 (C) Fehling's solution      (D)  $\text{NaHSO}_3$

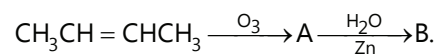
**Q.13** On vigorous oxidation by permanganate solution  $(\text{CH}_3)_2\text{C} = \text{CH}-\text{CH}_2\text{CH}_2\text{CH}_3$  gives **(2002)**

- (A)  $\text{CH}_3-\overset{\text{OH}}{\underset{\text{CH}_3}{\text{C}}}-\overset{\text{OH}}{\text{CH}}-\text{CH}_2\text{CH}_3$   
 (B)  $\text{CH}_3-\text{CH}(\text{CH}_3)-\text{CO}_2\text{H} + \text{CH}_3\text{COOH}$   
 (C)  $\text{CH}_3-\text{CH}(\text{CH}_3)-\text{CHO} + \text{CH}_3\text{CH}_2\text{CH}_2\text{OH}$   
 (D)  $\text{CH}_3-\text{C}(\text{CH}_3)=\text{O} + \text{CH}_3\text{CH}_2\text{COOH}$

**Q.14** Silver Mirror test is given by which one of the following compounds **(2011)**

- (A) Acetaldehyde      (B) Acetone  
 (C) Formaldehyde      (D) Benzophenone

**Q.15** In the following sequence of reactions, the alkene affords the compound 'B'



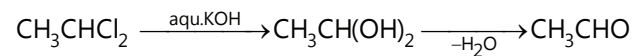
The compound B is **(2008)**

- (A)  $\text{CH}_3\text{CH}_2\text{CHO}$       (B)  $\text{CH}_3\text{COCH}_3$   
 (C)  $\text{CH}_3\text{CH}_2\text{COCH}_3$       (D)  $\text{CH}_3\text{CHO}$

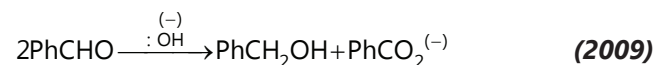
**Q.16** Which of the following on heating with aqueous KOH, produces acetaldehyde? (2009)

- (A)  $\text{CH}_3\text{COCl}$  (B)  $\text{CH}_3\text{CH}_2\text{Cl}$   
(C)  $\text{CH}_2\text{ClCH}_2\text{Cl}$  (D)  $\text{CH}_3\text{CHCl}_2$

**Q.17** In Cannizzaro reaction given below,

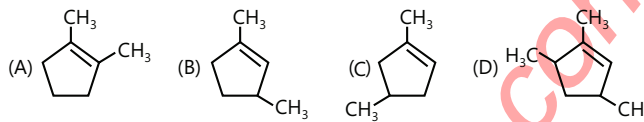


the slowest step is:



- (A) The attack of OH at the carboxyl group  
(B) The transfer of hydride to the carbonyl group  
(C) The abstraction of proton from the carboxylic group  
(D) The decomposition of  $\text{CH}_2\text{OH}$

**Q.18** Which compound would give 5-keto-2-methylhexanal upon ozonolysis. (2015)



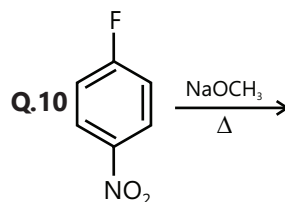
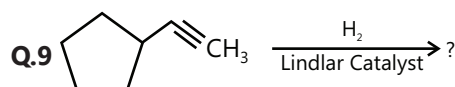
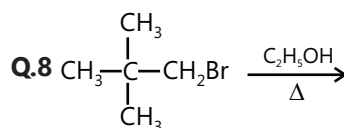
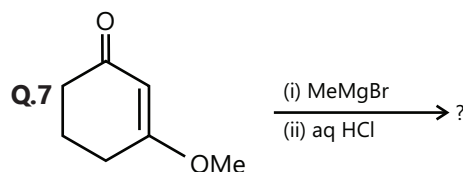
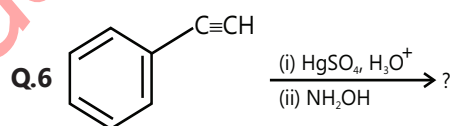
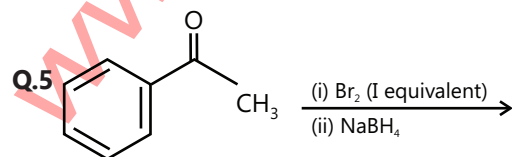
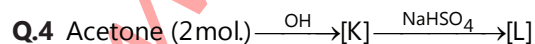
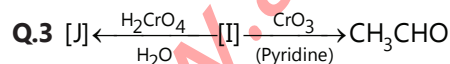
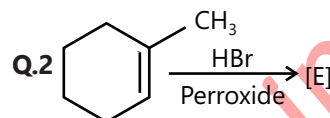
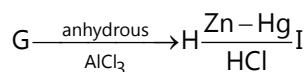
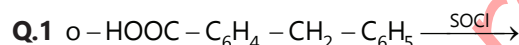
**Q.19** Ozonolysis of an organic compound gives formaldehyde as one of the product. This confirms the presence of: (2011)

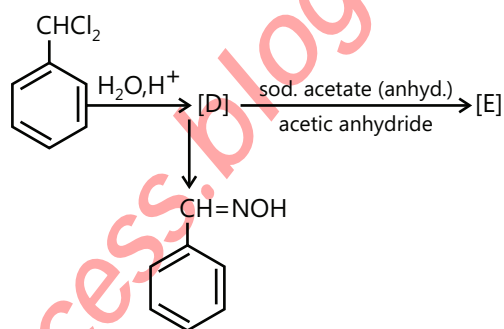
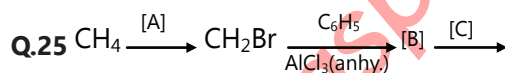
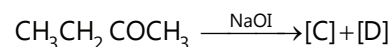
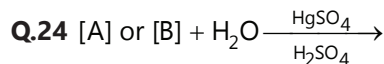
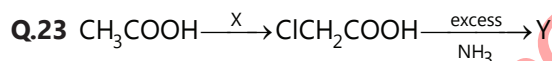
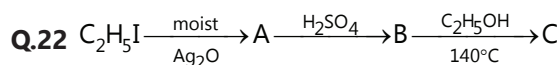
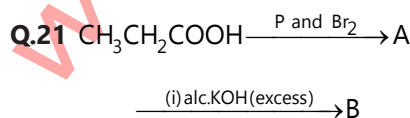
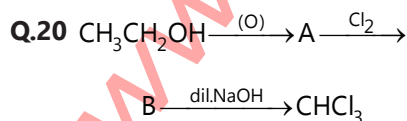
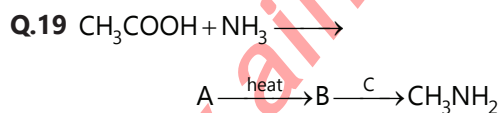
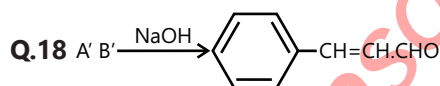
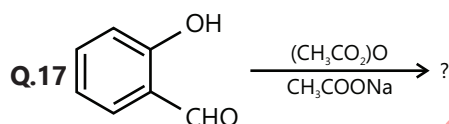
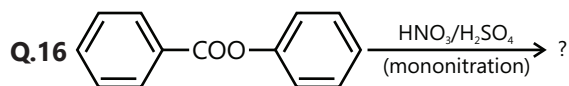
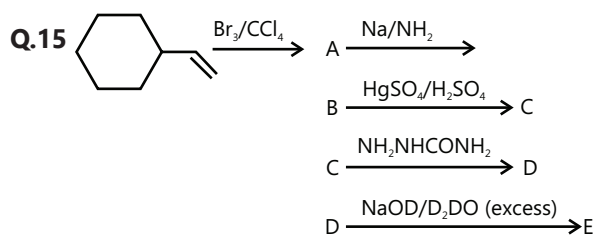
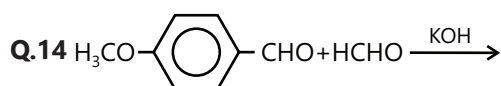
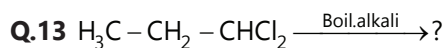
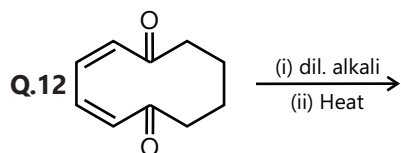
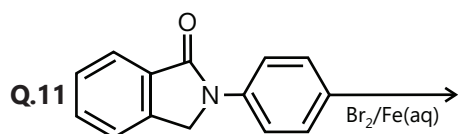
- (A) A vinyl group  
(B) An isopropyl group  
(C) An acetylenic triple bond  
(D) Two ethylenic double bonds

## JEE Advanced/Boards

### Exercise 1

Complete the following equations and identify the products A, B, C, D, E, F, G, H etc in the following reactions





Q.26 Explain giving reasons

(i) Solubility of carbonyl compounds decreases with the increase in their molecular masses.

(ii) Sodium bisulphite is used for the purification of aldehydes and ketones.

(iii) Oxidation of toluene with chromium trioxide to benzaldehyde is carried out in presence of acetic anhydride.

(iv) Although aldehydes are easily oxidisable yet propanal can conveniently be prepared by the oxidation of propanol by acidic dichromate.

(v) part of the group does not react with hydroxylamine hydrochloride.

Q.27 Give Reason

(i)  $\text{Me}_3\text{CCH}_2\text{COOH}$  is more acidic than  $\text{Me}_3\text{SiCH}_2\text{COOH}$ .

(ii) The  $K_2$  for fumaric acid is greater than for maleic acid.

(iii) Carbon oxygen bond lengths in formic acid are 1.23 Å and 1.36 Å and both the carbon oxygen bonds in sodium formate have the same value i.e. 1.27 Å.

(iv) The reaction  $\text{CH}_3\text{COOC}_2\text{H}_5 + \text{H}_2\text{O} \rightarrow \text{CH}_3\text{COOH} + \text{C}_2\text{H}_5\text{OH}$  is slow in the beginning but fast subsequently

(v) Although both  $>C=O$  and  $>C=C<$  groupings have double bond, they exhibit different types of addition reaction.

**Q.28** An organic compound (A)  $C_9H_{12}O$  was subjected to a series of tests in the laboratory. It was found that this compound.

- (i) Rotates the plane of polarised light.
- (ii) Evolves hydrogen with sodium.
- (iii) Reacts with  $I_2$  and  $NaOH$  to produce a pale yellow solid compound.
- (iv) Does not react with  $Br_2/CCl_4$ .
- (v) Reacts with hot  $KMnO_4$  to form compound (B)  $C_7H_6O_2$  which also be synthesised by the reaction of benzene and carbonyl chloride followed by hydrolysis.
- (vi) Loss optical activity as a result of formation of compound (C) on being heated with  $HI$  and  $P$ .
- (vii) Reacts Lucas reagent in about 5 min. Give structure of A and C with proper reasoning and draw Fischer projections for (A). Give reactions for the steps wherever possible.

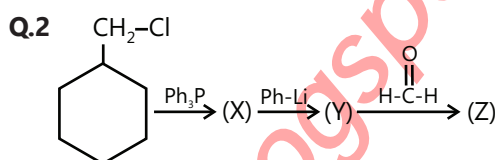
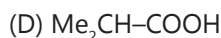
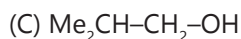
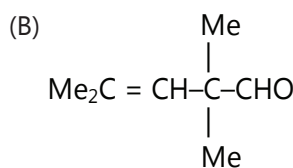
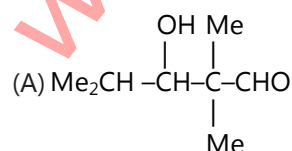
**Q.29** When 0.0088 g of a compound (A) was dissolved in 0.5 g of camphor, the melting point of camphor was lowered by  $8^\circ C$ . Analysis of (A) gave 68.18% C and 13.63% H. Compound (A) showed the following reactions:

- (a) It reacted with acetyl chloride and evolved hydrogen with sodium.
- (b) When reacted with  $HCl + ZnCl_2$ , a dense oily layer separated out immediately. Compound (A) was passed over  $Al_2O_3$  at  $350^\circ C$  to give compound (B) which on ozonolysis gives (C) and (D) which gave positive test with carbonyl reagents but only (C) gave a positive test with Fehling Sol: and resinous substance with  $NaOH$ . Identify (A), (B), (C) and (D) with proper reasoning.  $K_f$  for camphor =  $40 K kg mol^{-1}$ .

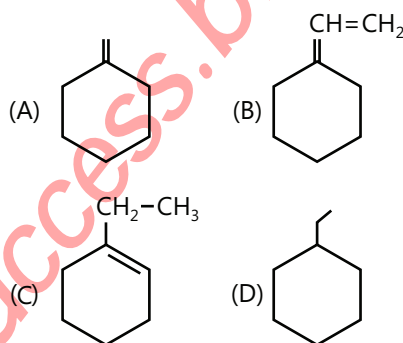
## Exercise 2

### Single Correct Choice Type

**Q.1**  $Me_2CH-CHO \xrightarrow[\Delta]{NaOH}$  Major products of this reaction is -

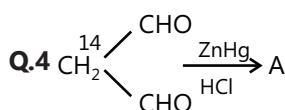


End product (Z) in above reaction



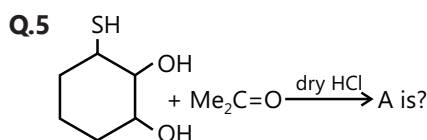
**Q.3** If 3-hexanone is reacted with  $NaBH_4$  followed by hydrolysis with  $D_2O$  the product will be

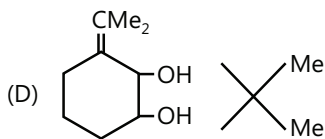
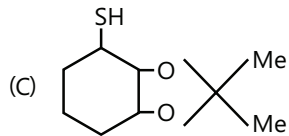
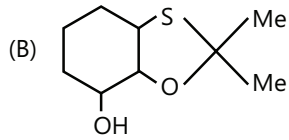
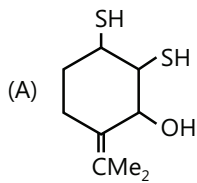
- (A)  $CH_3CH_2CH(OD)CH_2CH_2CH_3$
- (B)  $CH_3CH_2D(OH)CH_2CH_2CH_3$
- (C)  $CH_3CH_2CH(OH)CH_2CH_2CH_3$
- (D)  $CH_3CH_2CD(OD)CH_2CH_2CH_3$



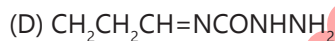
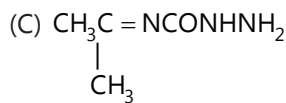
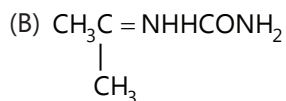
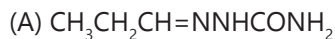
Final major product of this reaction is

- (A)  $^{14}CH_3CH_2CH_3$  (B)  $^{14}CH_3CH_2CH_3$
- (C)  $^{14}CH_3CH_2-CHO$  (D)  $^{14}CH_3-CH_2-CHO$

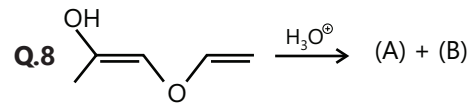
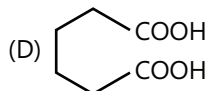
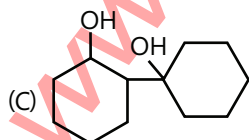
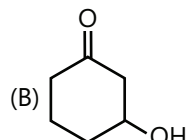
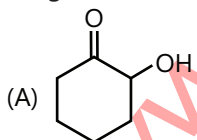




**Q.6** Compound A (molecular formula  $C_2H_8O$ ) is treated with acidified potassium dichromate to form a product B (molecular formula  $C_3H_6O$ ). B forms a shining silver mirror on warming with ammoniacal silver nitrate, B when treated with an aqueous sol of  $NH_2NHCONH_2$  and sodium acetate gives a product C. Identify the structure of C.



**Q.7** When cyclohexanone is treated with  $Na_2CO_3$  sol, we get



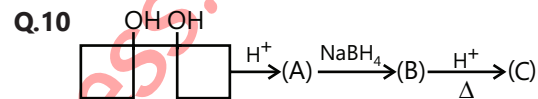
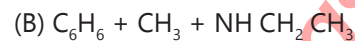
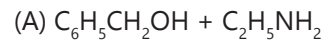
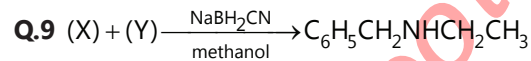
(A) + (B) formed can be distinguished by -

(A) Iodoform

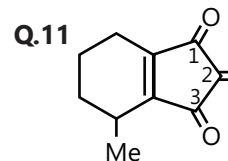
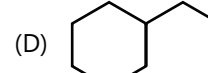
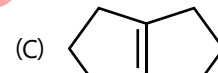
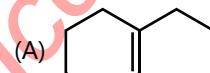
(B) Fehling

(C)  $NaHSO_3$

(D) 2, 4-DNP



(Major). Product C is



above compound is hydrated maximum at which position?

(A) 1

(B) 2

(C) 3

(D) Equal

**Q.12**  $Et-C(=O)-Me$  is prepared as one of the products by



dry distillation of calcium salt of which of the following acids:

(A) Ethanoic acid and methanoic acid

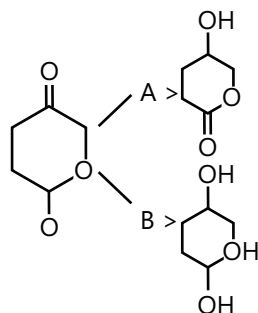
(B) Propanoic acid and methanoic acid

(C) Propanoic acid and ethanoic acid

(D) None of these



**Q.13** Reagents A & B are

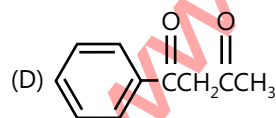
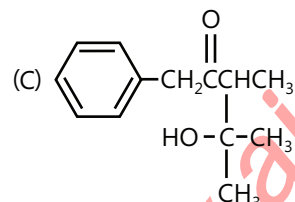
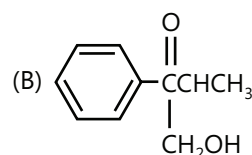
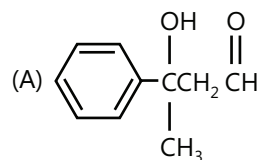


- (A)  $H_2/Pd$  &  $LiAlH_4$  (B)  $LiAlH_4$  &  $NaBH_4$   
 (C)  $NaBH_4$  &  $LiAlH_4$  (D)  $LiAlH_4$  &  $H_2/Pd$

**Q.14** The reagent used to distinguish ethanol & acetone is

- (A) Schiff's reagent (B) Fehling's sol.  
 (C) Ceric ammonium nitrate (D) Iodine with NaOH

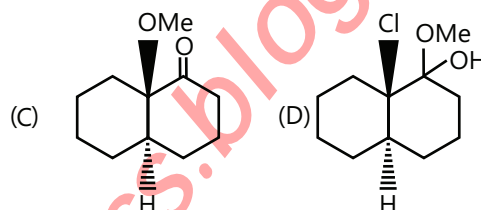
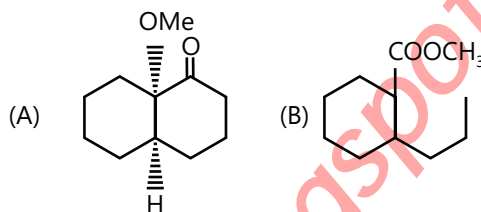
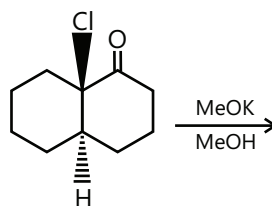
**Q.15** Which one of the following compounds is the best candidate for being prepared by an efficient mixed aldol addition reaction?



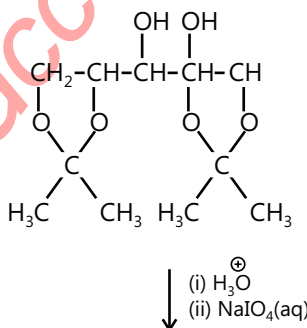
**Q.16** PhCHO and HCHO will behave differently with which of the following reagents

- (A) Tollen's Reagent (B) Fehling's sol.  
 (C) Schiff's reagent (D)  $NaBH_4$

**Q.17** Major product of this reaction is



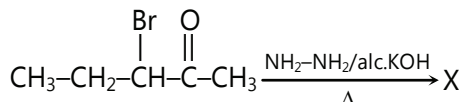
**Q.18** In the given reaction



Product will be -

- (A) 1 mole HCOOH and 1 mole HCHO  
 (B) 2 mole HCOOH and 1 mole HCHO  
 (C) 2 mole HCHO and 1 mole HCOOH  
 (D) 2 mole HCHO and 4 mole HCOOH

**Q.19** In the given reaction

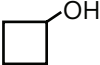


[X] will be -

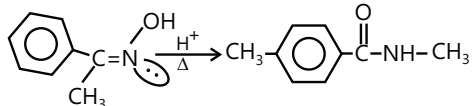
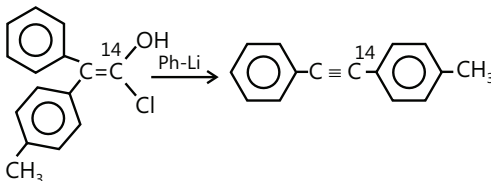
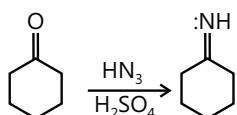
- (A) (B)   
 (C) (D)

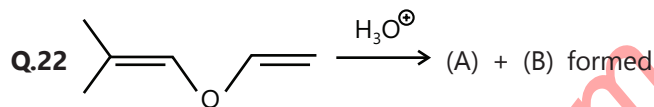
**Multiple Correct Choice Type**

**Q.20** Compound (X)  $C_4H_8O$ , which gives 2, 4-Dinitrophenyl hydrazine derivative (orange or red or yellow colour) and negative haloform test.

- (A)  $CH_3-CH=CH-\overset{\overset{O}{\parallel}}{C}-CH_3$  (B)  $CH_3-\underset{\underset{CH_3}{|}}{CH}-CHO$   
 (C)  (D)  $CH_3-CH_2-CH_2-CHO$

**Q.21** Which of the following reaction is not representing major product -

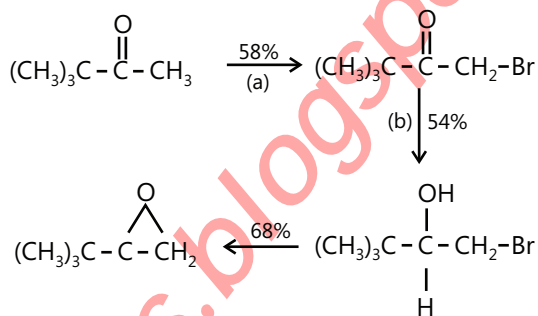
- (A) 
- (B) 
- (C)  $Ph-\overset{\overset{O}{\parallel}}{C}-NH_2 \xrightarrow[KOH]{Br_2} Ph-NH_2$   
Hoffman Bromamide
- (D) 



cannot be differentiated by

- (A) Iodoform (B) Fehling  
 (C)  $NaHSO_3$  (D) 2, 4-DNP

**Comprehension Type**



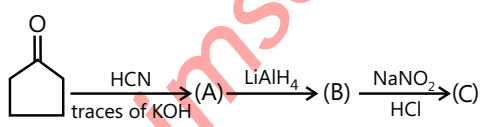
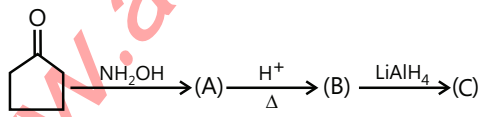
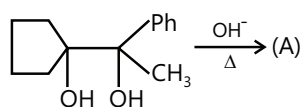
**Q.23** Suggest a reagent appropriate step (a) the synthesis -

- (A)  $HO^- / Br_2$  (1 mole) (B)  $H^+ / Br_2$  (1 mole)  
 (C) Both (A) and (B) (D) None of these

**Q.24** Yield of each step as actually carried out in laboratory is given each arrow. What is over all yield of the reaction ?

- (A) 60% (B) 21% (C) 40% (D) 68%

**Q.25 Match the column**

	Column I	Column II
(A)		(p) Formation of six member ring takes place
(B)		(q) Final product is Ketone
(C)	$CH_3-\overset{\overset{O}{\parallel}}{C}-CH_2-CH_2-CH_2-\overset{\overset{O}{\parallel}}{C}-OH \xrightarrow[\Delta]{OH^-} (A)$	(r) Final product will give positive Tollen's test
(D)		(s) Final product formed will react with 2, 4-DNP, (2, 4-Di-nitrophenyl hydrazine)

**Q.26 Match the column**

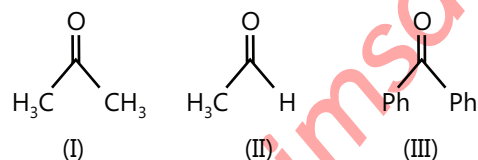
	Column I		Column II
(A)	$\begin{array}{c} \text{Me} \\ \diagdown \\ \text{C}=\text{N}-\text{OH} \\ \diagup \\ \text{Et} \end{array} \xrightarrow[\Delta]{\text{conc. H}_2\text{SO}_4} \text{Product}$	(p)	Carbene formation is involved
(B)	$\text{Cyclopentanone} \xrightarrow{\text{MCPBA}} \text{Products (A)} \xrightarrow{\text{LiAlH}_4} \text{(B)} \xrightarrow[\text{HCl}]{\text{NaNO}_2} \text{(C)}$	(q)	Nitrene formation is involved
(C)	$\text{CH}_2=\text{CH}_2 + \text{NH}_3 \xrightarrow{\Delta} \text{Product}$	(r)	Carbocation formation is involved
(D)	$\text{trans-2-butene} \xrightarrow[\text{KOH/excess}]{\text{CHCl}_3} \text{Product}$	(s)	Final product is a cyclic compound
		(t)	Azonium ion formation is involved

**Previous Years' Questions**

**Q.1** A mixture of benzaldehyde and formaldehyde on heating with aqueous NaOH solution gives **(2001)**

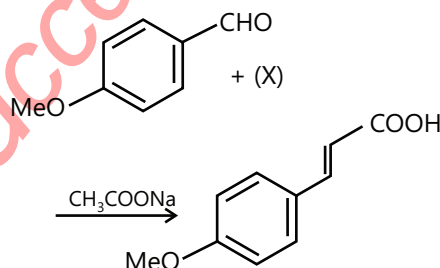
- (A) Benzyl alcohol and sodium formate
- (D) Sodium benzoate and methyl alcohol
- (C) Sodium benzoate and sodium formate
- (D) Benzyl alcohol and methyl alcohol

**Q.2** The order of reactivity of phenyl magnesium bromide with following compounds is **(2004)**



- (A) II > III > I
- (B) I > III > II
- (C) II > I > III
- (D) All the above react with the same rate

**Q.3** What is X? **(2005)**



- (A) CH<sub>3</sub>COOH
- (B) BrCH<sub>2</sub>COOH
- (C) (CH<sub>3</sub>CO)<sub>2</sub>O
- (D) HOC-COOH

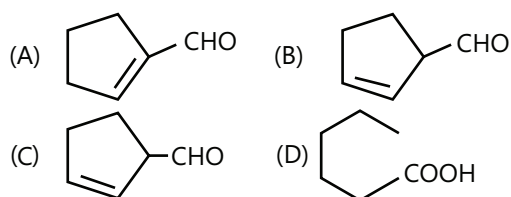
**Q.4** Butan-2-one can be converted to propanoic acid by which of the following? **(2006)**

- (A) NaOH, I<sub>2</sub>/H<sup>+</sup>
- (B) Fehling Sol:
- (C) NaOH, I<sub>2</sub>/H<sup>+</sup>
- (D) Tollen's reagent

**Q.5** The smallest ketone and its homologue are reacted with NH<sub>2</sub>OH to form oxime **(2006)**

- (A) Two different oximes are formed
- (B) Three different oximes are formed
- (C) Two oximes are optically active
- (D) All oximes are optically active

**Q.6** Cyclohexene on ozonolysis following reaction with zinc dust and water gives compound. Compound E on further treatment with aqueous KOH yields compound F. Compound F is - **(2007)**



**Q.7** Among the following compounds, which will react with acetone to give a product containing  $>C=N-$ ?  
**(2014)**

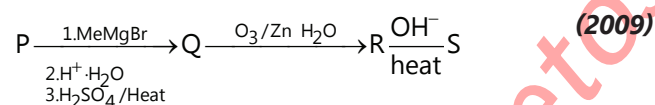


**Q.8** A new carbon bond formation is possible is **(1998)**

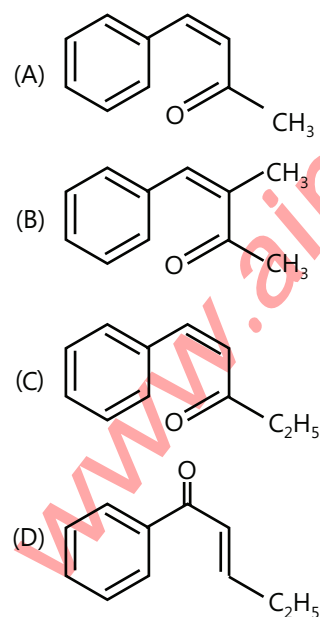
- (A) Cannizzaro's reaction  
 (B) Friedel-Craft's reaction  
 (C) Clemmensen's reduction  
 (D) Reimer-Tiemann reaction

**Paragraph 1**

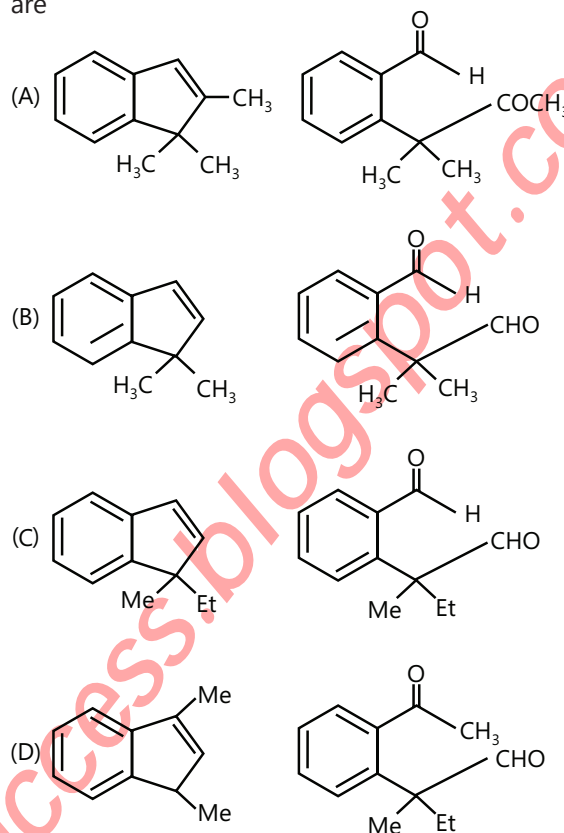
A carbonyl compound P, which gives positive iodoform test, undergoes reaction with  $MeMgBr$  followed by dehydration to give an olefin Q. Ozonolysis of Q leads to a dicarbonyl compound R, which undergoes intramolecular aldol reaction to give predominantly S.



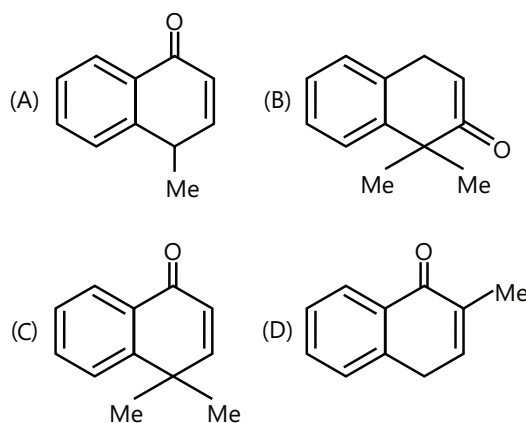
**Q.9** The structure of the carbonyl compound P, is



**Q.10** The structure of the product Q and R, respectively, are

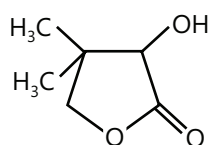


**Q.11** The structure of the product S, is-

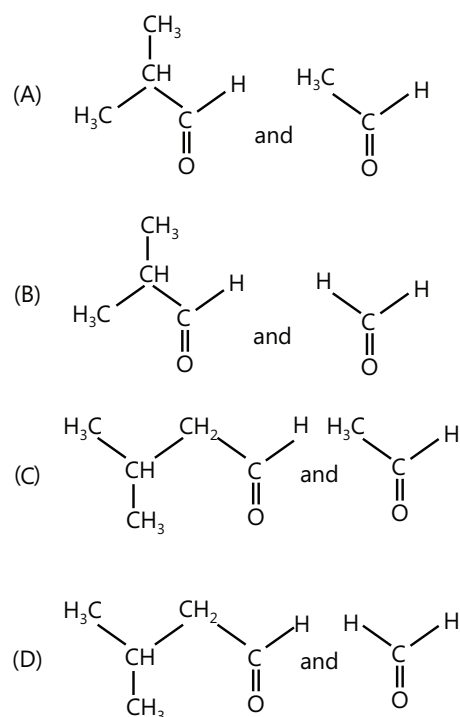


**Paragraph 2**

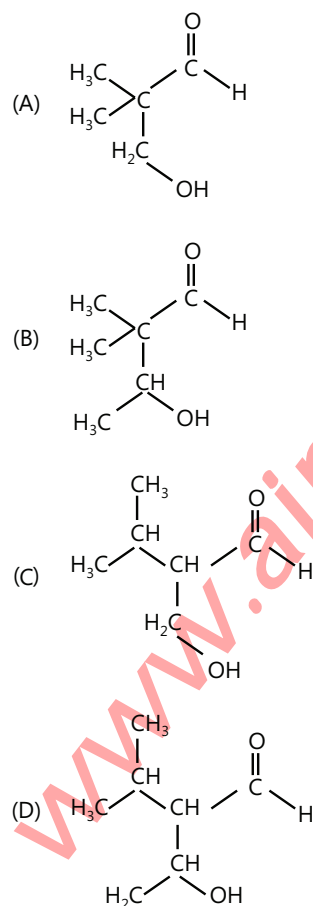
Two aliphatic aldehydes P and Q react in the presence of aqueous  $K_2CO_3$  to give compound R, which upon treatment with HCN provides compound S. On acidification and heating, S gives the product shown below: **(2010)**



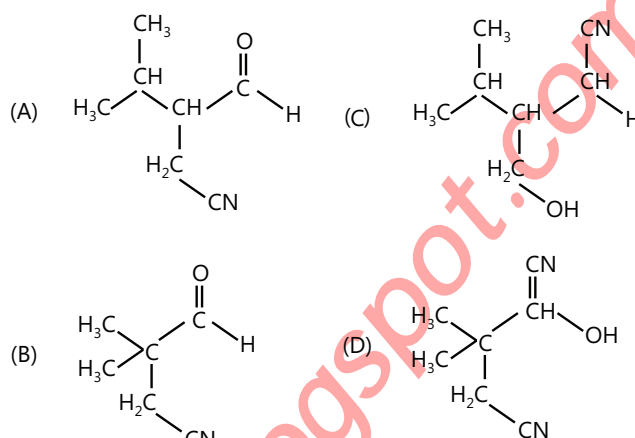
**Q.12** The compounds P and Q respectively are



**Q.13** The compound R is -



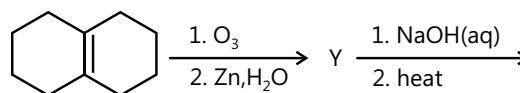
**Q.14** The compound S is -



**Q.15** Match compounds/ions in column I with their properties / reactions in column II. (2007)

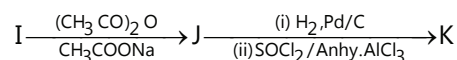
	Column I		Column II
(A)	$C_6H_5CHO$	(p)	gives precipitate with 2,4-dinitrophenylhydrazine
(B)	$CH_3C\equiv CH$	(q)	gives precipitate with $AgNO_3$
(C)	$CN^-$	(r)	is a nucleophile
(D)	$I^-$	(s)	is involved in cyanohydrin formation

**Q.16** In the scheme given below, the total number of intramolecular aldol condensation products formed from 'Y' is: (2010)



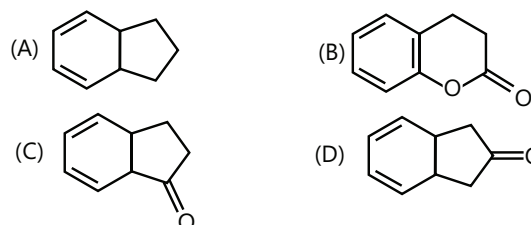
**Paragraph for Questions 17 and 18**

In the following reactions sequence, the compound J is an intermediate (2012)

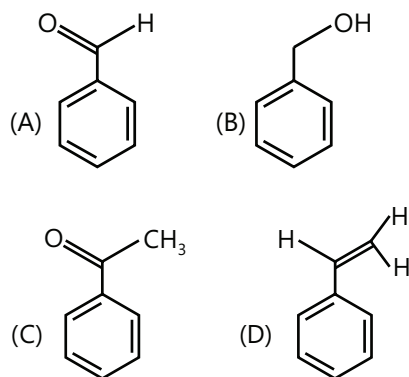


$J(C_9H_8O_2)$  gives effervescences on treatment with  $NaHCO_3$  and positive Baeyer's test.

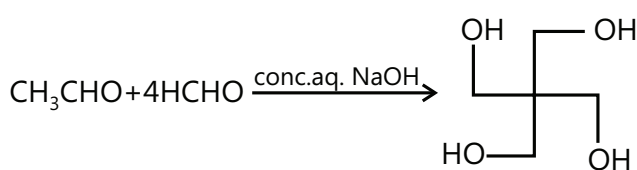
**Q.17** The compound K is



**Q.18** The compound I is

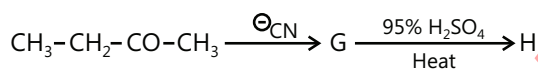


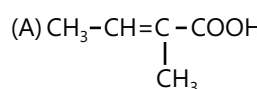
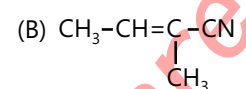
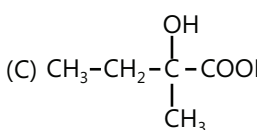
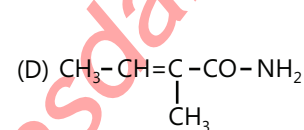
**Q.19** The number of aldol reaction(s) that occurs in the given transformation is (2012)



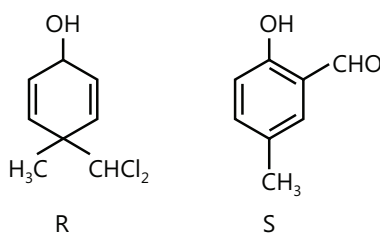
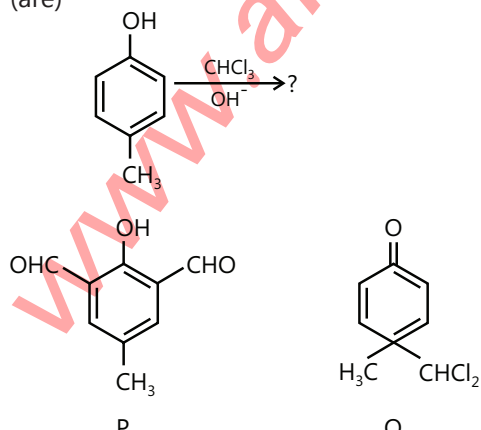
- (A) 1 (B) 2 (C) 3 (D) 4

**Q.20** The major product H in the given reaction sequence is (2012)



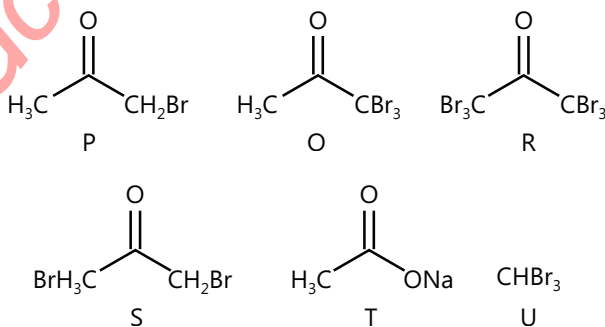
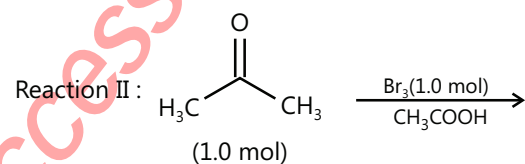
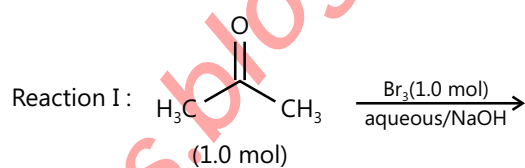
- (A)  (B) 
- (C)  (D) 

**Q.21** In the following reaction, the product(s) formed is (are) (2013)



- (A) P(major) (B) Q(minor)  
(C) R(minor) (D) S(major)

**Q.22** After completion of the reactions (I and II), the organic compound(s) in the reaction mixtures is(are) (2013)

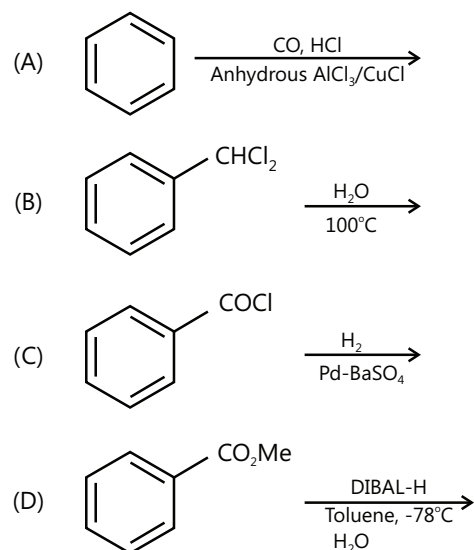


- (A) Reaction I: P and Reaction II: P  
(B) Reaction I: U, acetone and Reaction II: Q, acetone  
(C) Reaction I: T, U, acetone and Reaction II: P  
(D) Reaction I: R, acetone and Reaction II: S, acetone

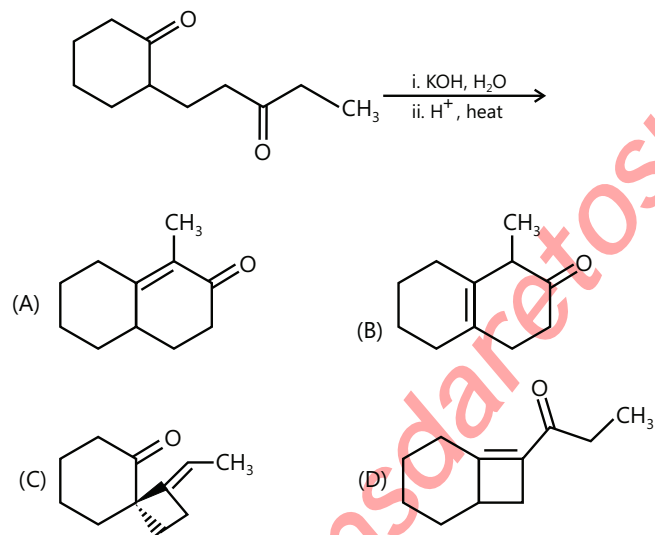
**Q.23** The most suitable reagent for the conversion of  $\text{R-CH}_2\text{-OH} \rightarrow \text{R-CHO}$  is: (2014)

- (A)  $\text{KMnO}_4$   
(B)  $\text{K}_2\text{Cr}_2\text{O}_7$   
(C)  $\text{CrO}_3$   
(D) PCC (Pyridinium chlorochromate)

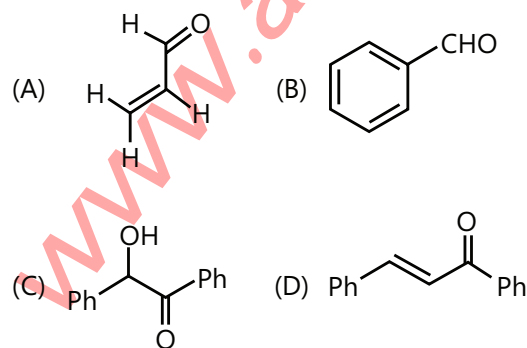
**Q.24** Among the following, the number of reaction(s) that produce(s) benzaldehyde is (2015)



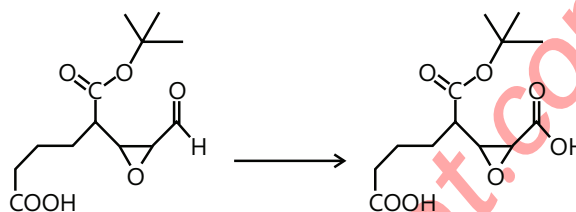
**Q.25** The major product of the following reaction is (2015)



**Q.26** Positive test is observed for (2016)

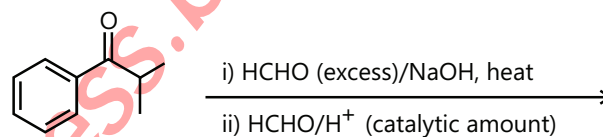


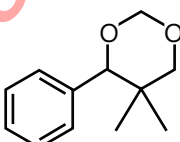
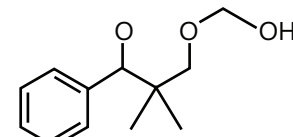
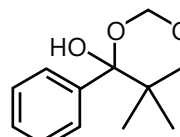
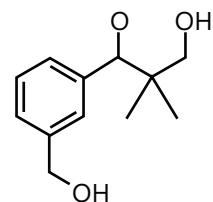
**Q.27** Reagents which can be used to bring about the following transformation is (2016)



- (A) LiAlH<sub>4</sub> in (C<sub>2</sub>H<sub>5</sub>)<sub>2</sub>O  
 (B) BH<sub>3</sub> in THF  
 (C) NaBH<sub>4</sub> in C<sub>2</sub>H<sub>5</sub>OH  
 (D) Raney Ni/H<sub>2</sub> in THF

**Q.28** (2016)



- (A) 
- (B) 
- (C) 
- (D) 

# PlancEssential Questions

## JEE Main/Boards

### Exercise 1

Q.1      Q.3      Q.9  
Q.10     Q.16     Q.22

### Exercise 2

Q.3      Q.8      Q.12  
Q.15

### Previous Years' Questions

Q.2      Q.7      Q.8  
Q.12

## JEE Advanced/Boards

### Exercise 1

Q.11     Q.12     Q.15  
Q.25     Q.26 (4)   Q.27 (3)  
Q.28 (5-i)

### Exercise 2

Q.2      Q.6      Q.8  
Q.9      Q.17     Q.18  
Q.25

### Previous Years' Questions

Q.9      Q.14

## Answer Key

## JEE Main/Boards

### Exercise 2

#### Single Correct Choice Type

Q.1 B      Q.2 B      Q.3 C      Q.4 A      Q.5 C      Q.6 A  
Q.7 C      Q.8 B      Q.9 D      Q.10 C     Q.11 C     Q.12 C  
Q.13 B     Q.14 B     Q.15 D     Q.16 D

### Previous Years' Questions

Q.1 D      Q.2 B      Q.3 A      Q.4 B      Q.5 A      Q.6 B  
Q.7 C      Q.8 D      Q.9 A      Q.10 A     Q.11 B     Q.12 C  
Q.13 D     Q.14 A, C   Q.15 D     Q.16 D     Q.17 A     Q.18 B  
Q.19 A



## JEE Advanced/Boards

### Exercise 2

#### Single Correct Choice Type

Q.1 C	Q.2 C	Q.3 A	Q.4 B	Q.5 B	Q.6 A	Q.7 C
Q.8 A	Q.9 D	Q.10 C	Q.11 B	Q.12 C	Q.13 C	Q.14 C
Q.15 B	Q.16 B	Q.17 B	Q.18 D	Q.19 C		

#### Multiple Correct Choice Type

Q.20 B, D	Q.21 A, B, D	Q.22 B, C, D
-----------	--------------	--------------

#### Comprehension Type

Q.23 C	Q.24 B
--------	--------

#### Match the Columns

Q.25 A → p, q, s; B → p; C → p, q, s; D → p, q, s;	Q.26 A → r; B → r, s; C → q, s; D → p
--	---------------------------------------

### Previous Years' Questions

Q.1 A	Q.2 C	Q.3 C	Q.4 C	Q.5 B	Q.6 A	Q.7 A, D
Q.8 B, D	Q.9 B	Q.10 A	Q.11 B	Q.12 B	Q.13 A	Q.14 D
Q.15 A → p, q, s; B → q, r; C → q, r, s; D → q, r	Q.16 1	Q.17 C	Q.18 A	Q.19 C		
Q.20 B	Q.21 B, D	Q.22 C	Q.23 D	Q.24 A, B, C, D	Q.25 A	Q.26 A, B, C
Q.27 C	Q.28 A					

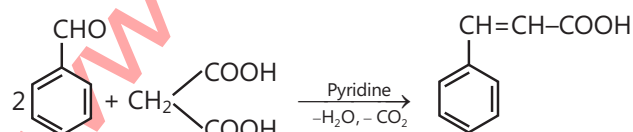
## Solutions

### JEE Main/Boards

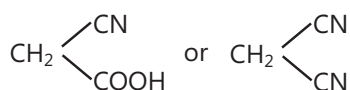
#### Exercise 1

**Sol 1:** Knoevenagel reaction

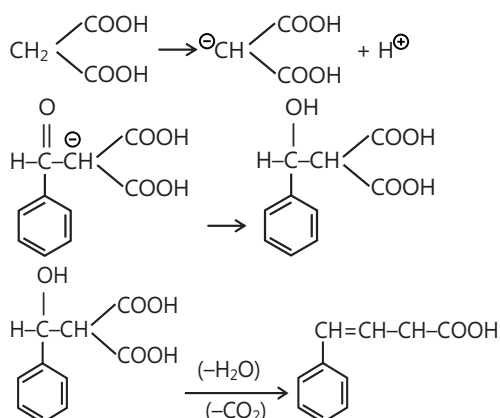
It is the condensation of any carbonyl compounds with compounds containing in active methylene compound in the presence of pyridine

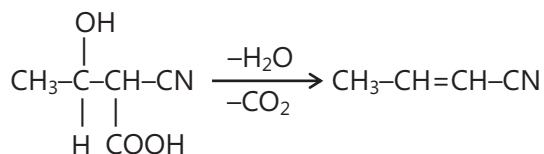
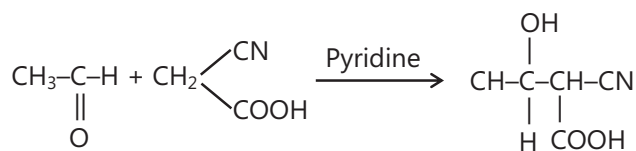


Instead of  $\text{CH}_2(\text{COOH})_2$  we can also use

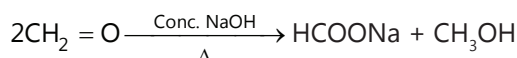


Mechanism

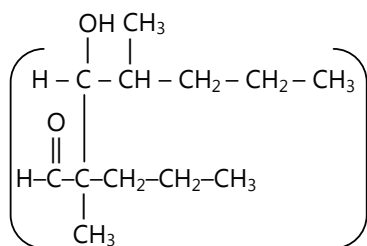
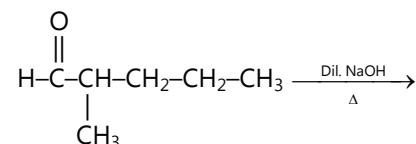




**Sol 2:** (i)  $\text{CH}_2 = \text{O}$  it will undergo cannizzaro reaction :

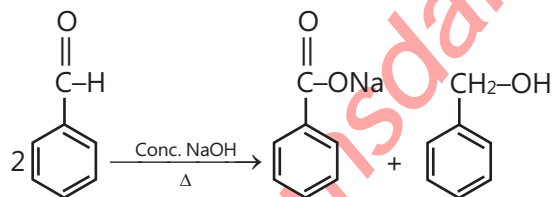


(ii) Aldol condensation

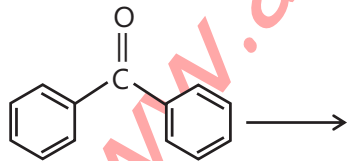


Cannizzaro reaction

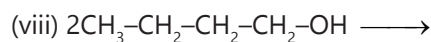
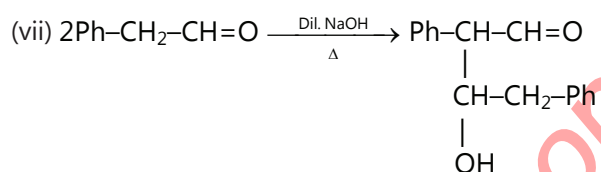
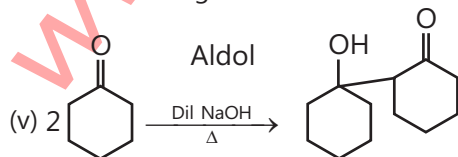
(iii) Benzaldehyde



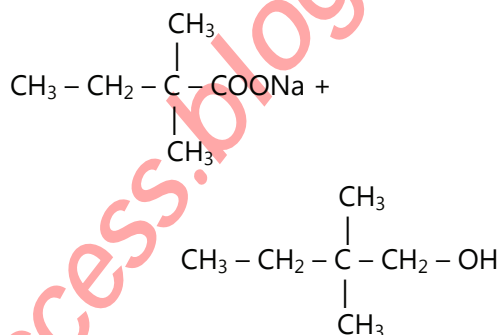
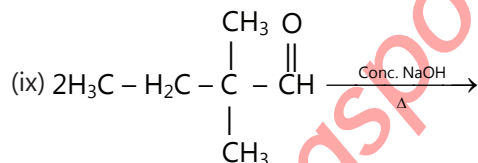
(iv) Benzophenone



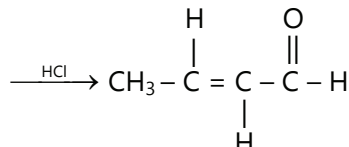
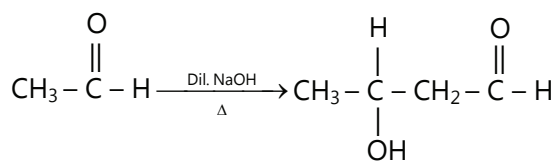
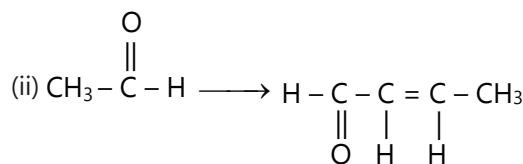
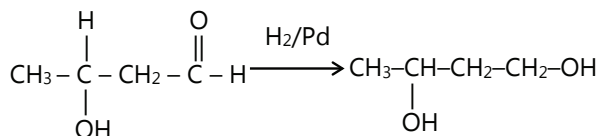
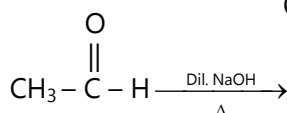
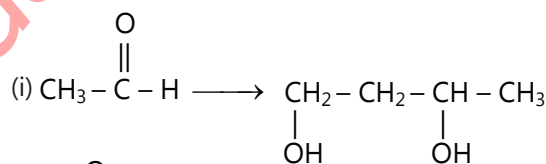
It will not undergo aldol or cannizzaro reaction

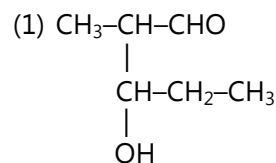
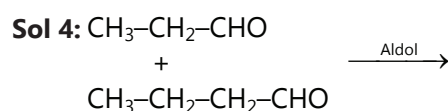
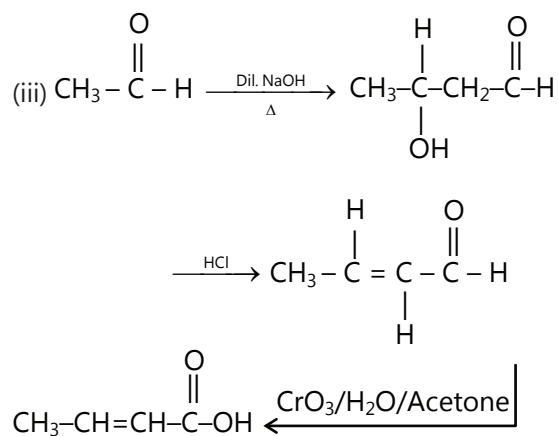


It will not undergo any reaction

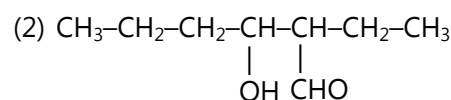


**Sol 3:**

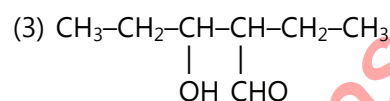




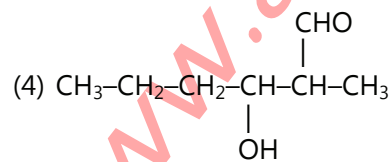
( $\text{CH}_3-\text{CH}_2-\text{CHO}$  is nucleophile  
 $\text{CH}_3-\text{CH}_2-\text{CHO}$  is electrophile)



( $\text{CH}_3-\text{CH}_2-\text{CH}_2-\text{CHO}$  is nucleophile  
 $\text{CH}_3-\text{CH}_2-\text{CH}_2-\text{CHO}$  is electrophile)



( $\text{CH}_3-\text{CH}_2-\text{CHO}$  is electrophile  
 $\text{CH}_3-\text{CH}_2-\text{CH}_2-\text{CHO}$  is nucleophile)

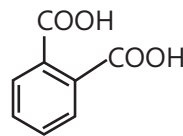


( $\text{CH}_3-\text{CH}_2-\text{CH}_2-\text{CHO}$  is electrophile  
 $\text{CH}_3-\text{CH}_2-\text{CHO}$  is nucleophile)

**Sol 5:**  $\text{C}_9\text{H}_{10}\text{O} \rightarrow$  gives +ve tollen's test

$\Rightarrow$  It is a aldehyde  $\rightarrow$  undergoes cannizzaro

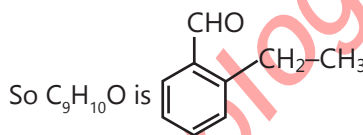
$\Rightarrow \alpha$  hydrogens not present  $\rightarrow$  vigorous oxidation  $\rightarrow$



$\Rightarrow \text{C}_9\text{H}_{10}\text{O}$  has two groups attached at neighbouring positions

$\Rightarrow$  1 group is aldehyde with no  $\alpha$ -hydrogen

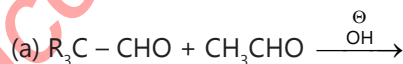
$\Rightarrow$  2<sup>nd</sup> group is ethyl group



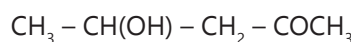
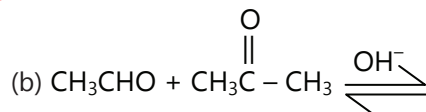
**Sol 6:** (i) Refer page-23.15 Section-6 in the sheet

(ii) When the condensation is between two different carbonyl compounds, it is called crossed aldol condensation.

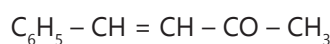
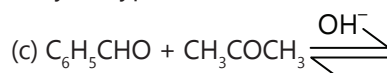
For example.



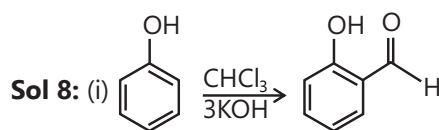
$\text{R}_3\text{C}-\text{CH}(\text{OH})-\text{CH}_2-\text{CHO}$  crossed product



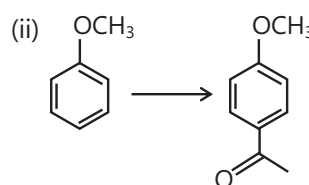
4-Hydroxypentan-2-one (crossed product)



**Sol 7:** (i) Fehling's Test, (ii) 2, 4 DNP Test

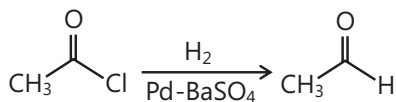


Reimer - Tiemann reaction

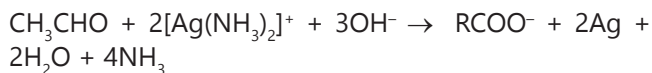


Friedel Craft Acylation

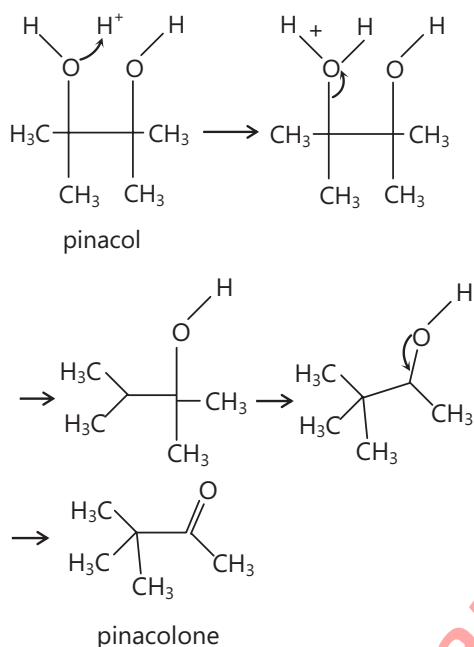
**Sol 9:** (i) Rosenmund Reduction



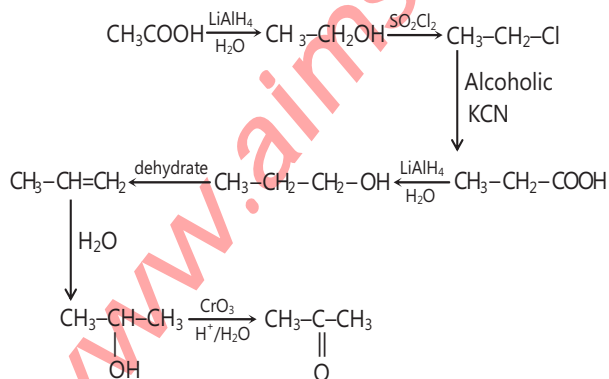
(ii) Tollen's Reagent



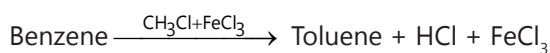
**Sol 10:** The pinacol-pinacolone rearrangement is a method for converting a 1,2-dial to a carbonyl compound in organic chemistry. This 1,2-rearrangement takes place under acidic conditions. The name of the reaction comes from the rearrangement of pinacole to pinacolone.



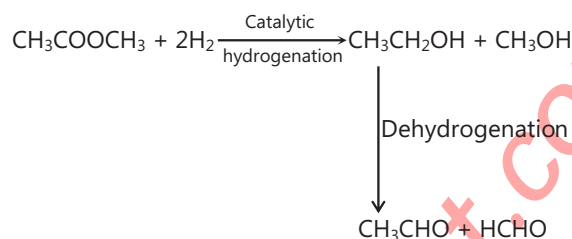
**Sol 11:** (i)



(ii) Friedel - Craft reaction



**Sol 12:** (a)



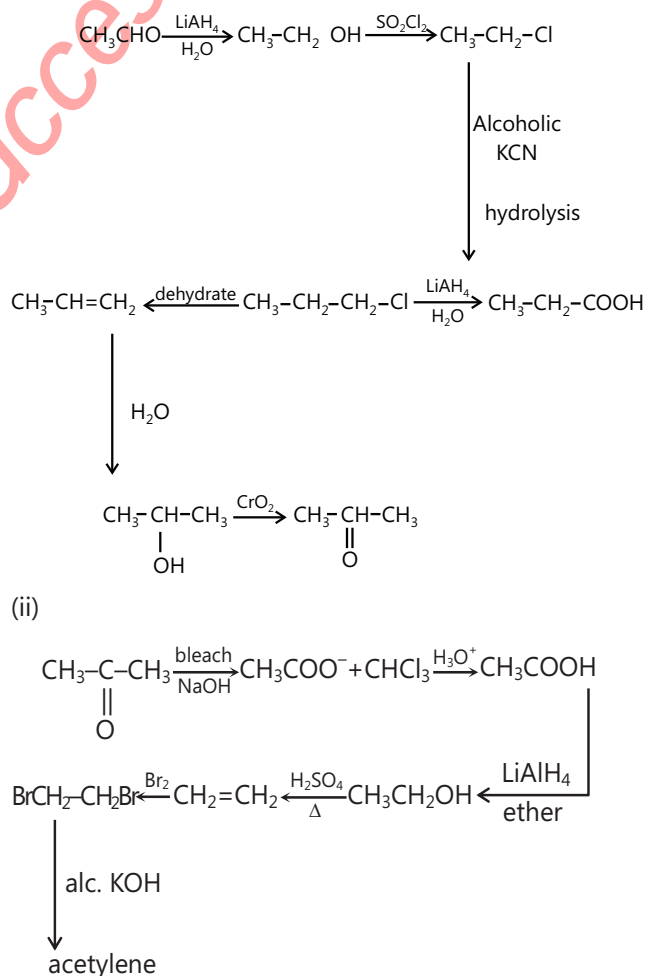
(b) (i) Due to the presence of  $\text{>C=O}$  group with is polar

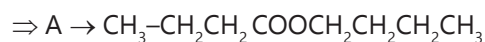
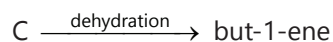
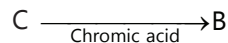
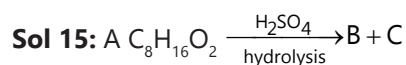
(ii) Aldehydes have lower boiling points as they are not associated with intermolecular

H-bonding whereas alcohols are associated with intermolecular H-bonding. Aldehydes have lower B. P.

**Sol 13:** Refer theory.

**Sol 14:** (i)





**Sol 16:** (i) 2-4 DNP test

Only carbonyl compounds give positive test

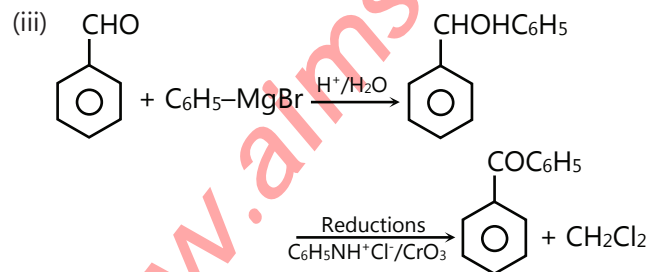
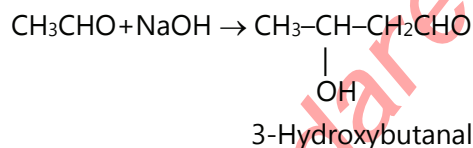
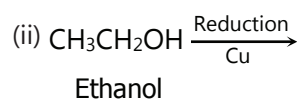
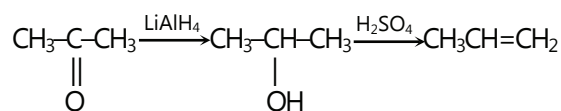
(ii) Acetophenone - It give iodoform test

Benzophenone-It doesn't give Iodoform test

(iii) Phenol - It give violet colour with  $\text{FeCl}_3$  test.

Benzoic acid-It doesn't give violet colour with  $\text{FeCl}_3$

**Sol 17:** (i)



**Sol 18:** (i) 2, 2, 6-trimethyl cyclohexanone has three methyl group at the alpha position. There is a lot of steric hindrance in this molecule. Due to steric hindrance the  $\text{CN}^-$  ion do not attack the molecule. There is not steric hindrance in cyclohexanone. Therefore it forms cyanohydrin in good percentage.

(ii) Semicarbazide has two  $-\text{NH}_2$  groups. The attachment of the two  $-\text{NH}_2$  groups on the

$\text{C} = \text{O}$  is different one  $-\text{NH}_2$  is directly attached to  $\text{C} = \text{O}$  while the other  $-\text{NH}_2$  is not directly attached out attached through  $-\text{NH}$ . Therefore due to resonance the electron density on this  $-\text{NH}_2$  group decrease and therefore cannot act as a nucleophile. The lone pair of electrons in  $-\text{NH}_2$  which is attached through  $-\text{NH}$  is not involved in resonance and therefore is available for nucleophilic attack on the  $\text{C} = \text{O}$ .

(iii) The reaction between carboxylic acid and alcohol is a reversible reaction. The ester and the water which is formed as a product of can again react to form carboxylic acid and alcohol so for a reaction to proceed in the forward direction in a reversible reaction, one of the product should be removed. That is the reason during the preparation of esters from a carboxylic acid and an alcohol in the presence of an acid catalyst, the water on the ester should be removed as soon as it is formed.

**Sol 19:** Calculation of molecular formula :-

% of C = 69.77

% of H = 11.63

% of O =  $100 - (69.77 + 11.63) = 18.6\%$

Ratio of C =  $69.77 / 12 = 5.88$

Ratio of H =  $11.63 / 1 = 11.63$

Ratio of O =  $18.6 / 16 = 1.16$

smallest ratio

C =  $5.88 / 1.16 = 5$

H =  $11.63 / 1.16 = 10$

O =  $1.16 / 1.16 = 1$

Empirical formula =  $\text{C}_5\text{H}_{10}\text{O}_1$

Mol mass = 86

$n = \text{molecular mass} / \text{Empirical formula mass} = 86 / 86 = 1$

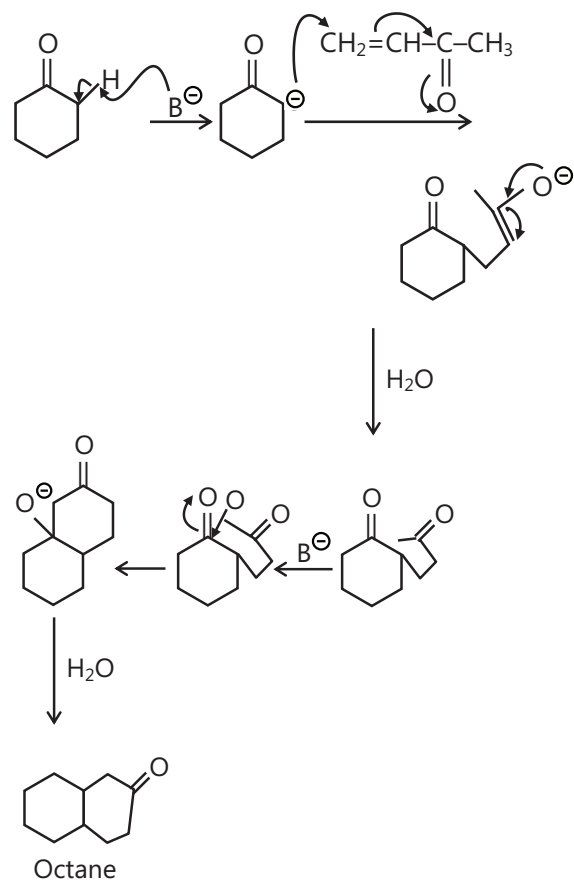
MF =  $\text{C}_5\text{H}_{10}\text{O}$

Since the compound forms on addition compounds with sodium hydrogensulphite, the said compound should be ketone as aldehyde.

Since the compound does not reduce Tollen's reagent, therefore it is a ketone. Since the compound gives positive iodoforms test, the compound should be methyl ketone. On vigorous oxidation it gives ethanoic and propanoic acid therefore the given compound should be pentan-2-one.



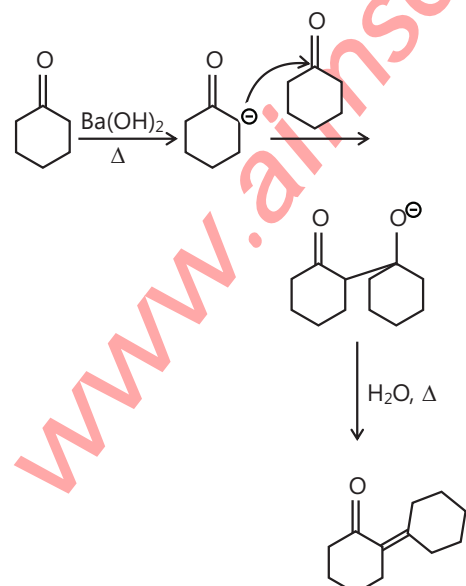
Sol 3: (C)



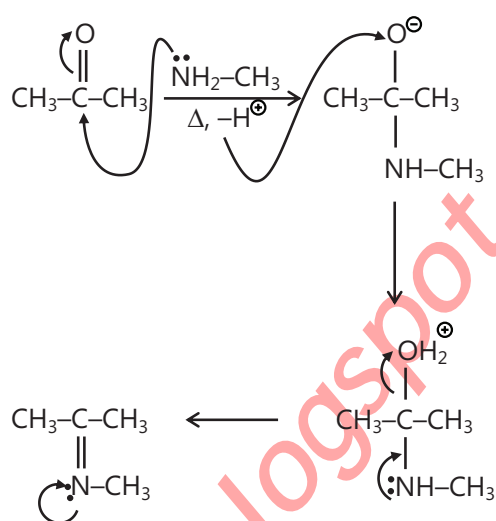
Sol 4: (A) It is carried out using  $\text{NaBH}_4$  as  $\text{NaBH}_4$  will not reduce ester and reduces only carbonyl part.

Sol 5: (C)  $\text{MeCHO}$  can undergo aldol condensation as it has more than 1  $\alpha$  hydrogen present.

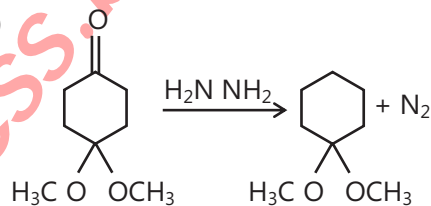
Sol 6: (A)



Sol 7: (C)



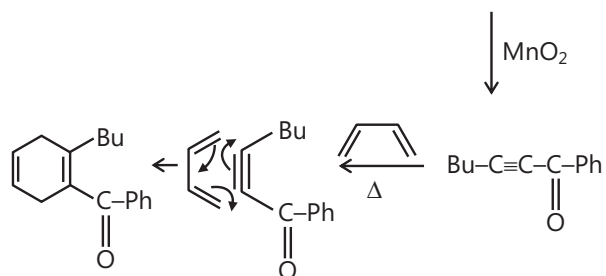
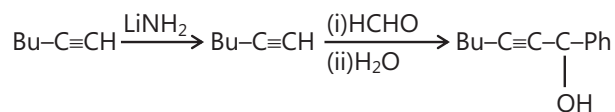
Sol 8: (B)



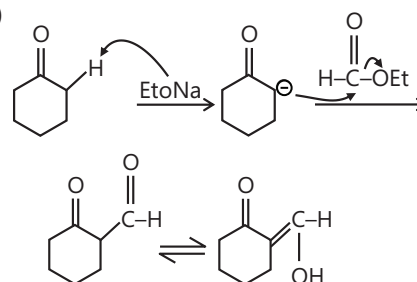
Wolf-kishner - reduction

In clemmenson reduction  $\text{HCl}$  will break ether bonds.

Sol 9: (D)



Sol 10: (C)





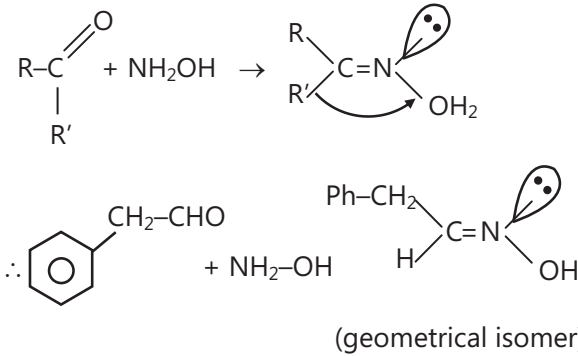
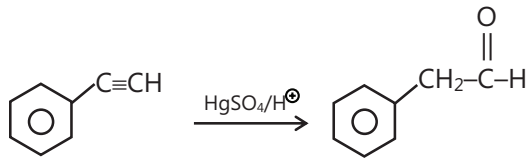
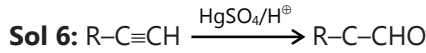
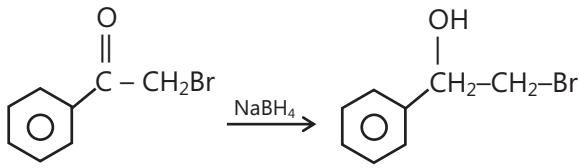




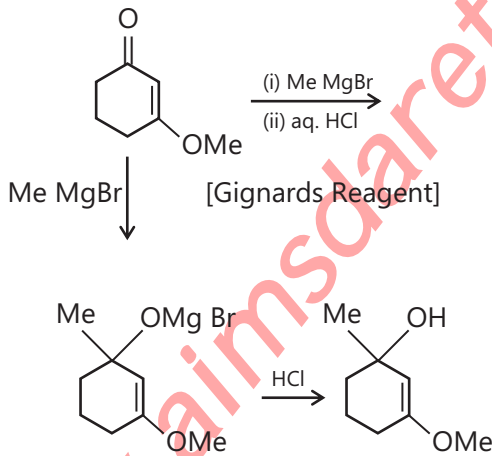


As only 1 equivalent is used, Br will be added to the alkyl group otherwise the phenyl ring also would have been substituted.

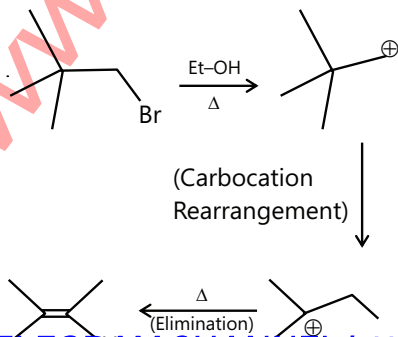
[NaBH<sub>4</sub> → weak reducing agent.]



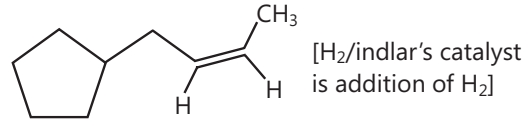
**Sol 7:**



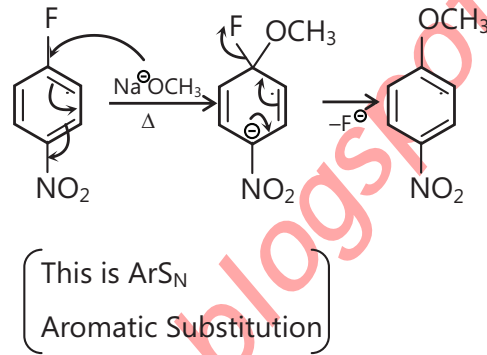
**Sol 8:**



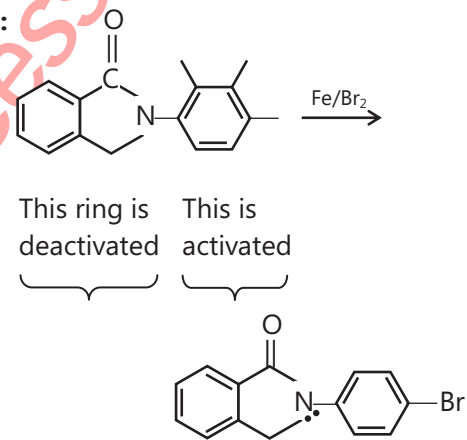
**Sol 9:**



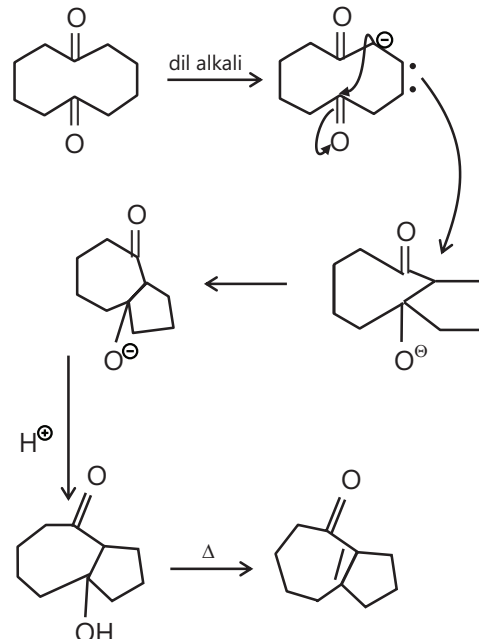
**Sol 10:**



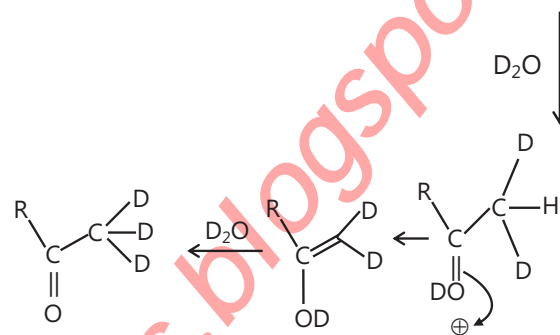
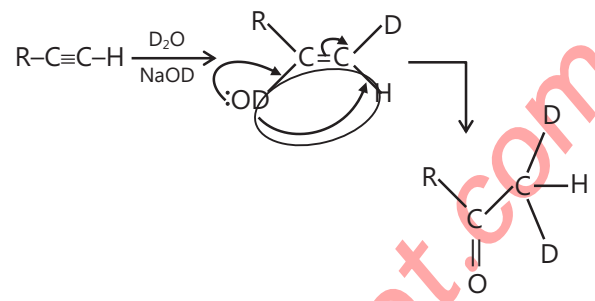
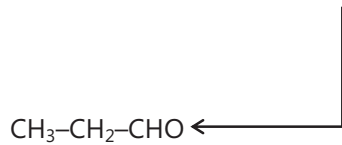
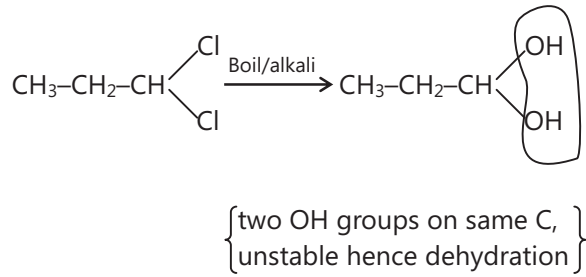
**Sol 11:**



**Sol 12:**



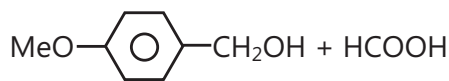
**Sol 13:**



**Sol 14:**



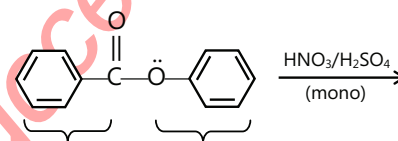
(Cannizzaro Reaction)



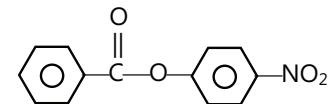
Here, alcohol is formed on the phenyl ring

Note :- as the (MeO -) group. Favours +ve charge (stabilizes)

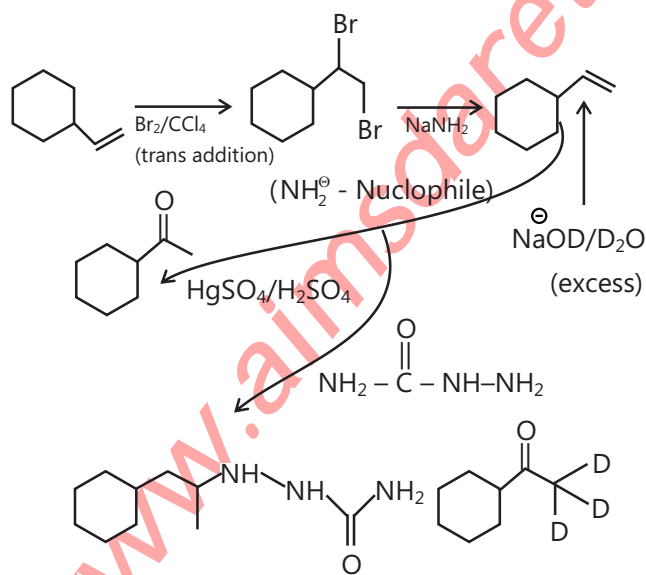
**Sol 16:**



Deactivated Activated

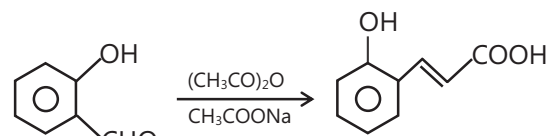


**Sol 15:**



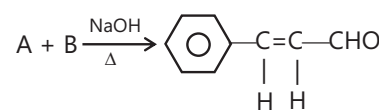
Mechanism with NaOD/D<sub>2</sub>O (excess)

**Sol 17:**

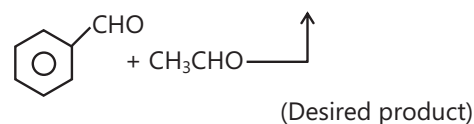


This is a very standard example of Perkin's condensation {If possible remember it}

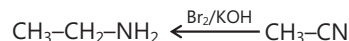
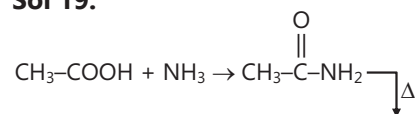
**Sol 18:**



{Aldol condensation}



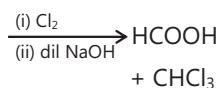
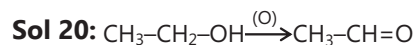
**Sol 19:**



Step 1 is : Nucleophilic substitution of -OH by -NH<sub>2</sub>

Step 2 is : Clearly dehydration

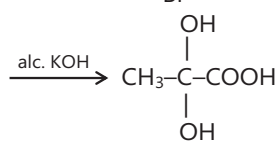
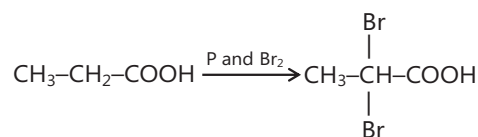
Step 3: Hoffman Bromamide Reaction (through the intermediate R-N=C=O)



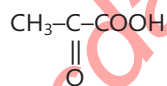
[Chloroform reaction]

Iodoform → presence of α-hydrogen

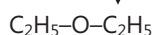
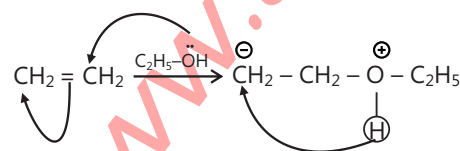
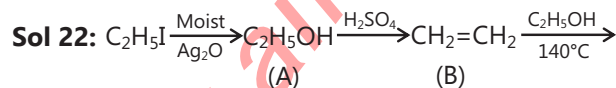
**Sol 21:**



dehydration

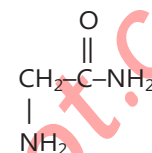
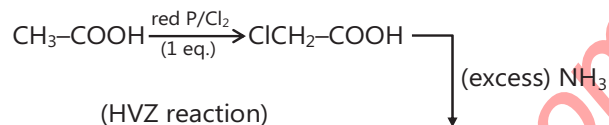


red P/Br<sub>2</sub> → Hell - Volhard Zelinski Reaction (HVZ)  
[α - bromination]



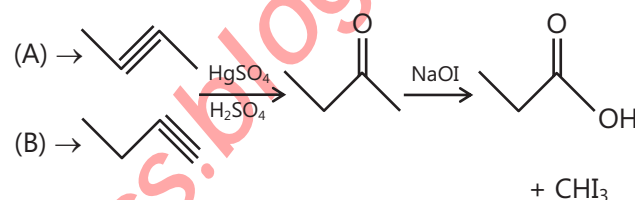
∴ (C) → Et - O - Et

**Sol 23:**



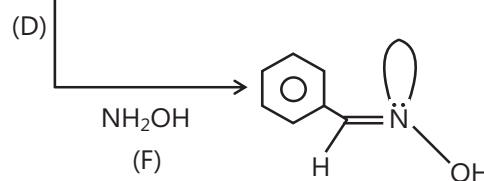
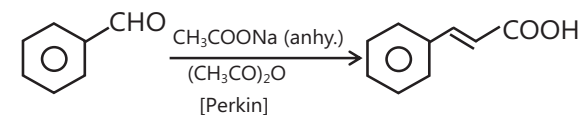
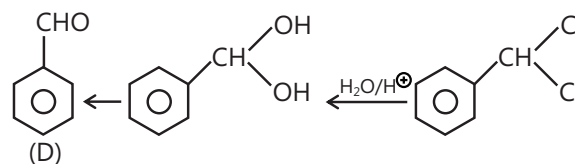
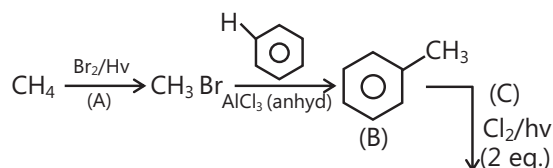
(NH<sub>2</sub><sup>⊖</sup> is a nucleophile)

**Sol 24:**



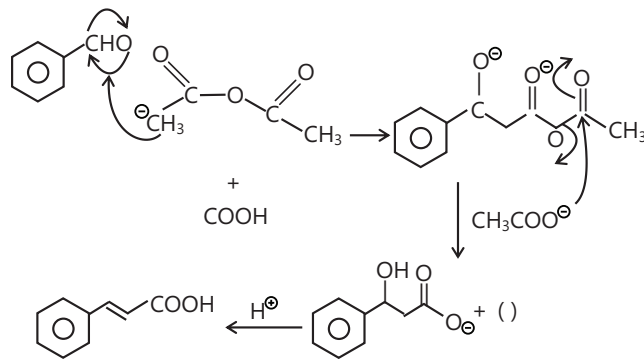
(Iodoform Reaction)

**Sol 25:**



(Mechanism)

Perkins



**Sol 26:** (i) Higher carbonyl compounds are insoluble in water due to more covalent character.

(ii) Bisulphites of  $\text{>C=O}$  are soluble in water

∴ Carbonyl compounds form solid additive products with NaHSO<sub>3</sub> which are separated out. The solid bisulphites of carbonyl compounds on hydrolysis by dil. acid regenerate original carbonyl compound.

(iii) Oxidation of toluene with chromium trioxide to benzaldehyde is carried out in presence of acetic anhydride because it converts benzaldehyde into its diacetate so preventing its further oxidation to acid form.

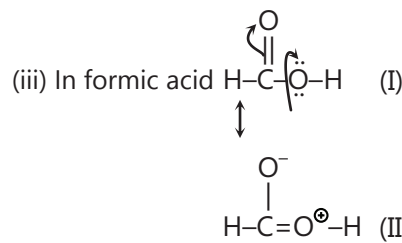
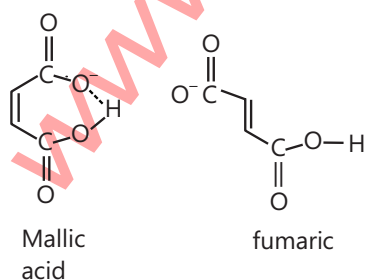
(iv) This is because aldehyde is more volatile than corresponding acid or alcohol.

(v) In a carboxylic acid, there is a pair of electrons on the oxygen in conjugation with carbonyl oxygen. This prevents the creation of a positive centre at carboxyl carbon. Therefore nucleophilic addition of phenyl hydrazine to give phenyl hydrazine is not possible.

**Sol 27:** (i) is more acidic than

because Si has empty orbital so can do backbonding and by this decreases the acidity.

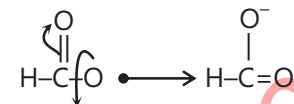
(ii) After first ionisation maleic acid ion is stabilised by hydrogen bonding but there is no such stabilisation in fumaric acid.



Structure (I) is more stable than structure (II)

So C=O bond length will be less than C-O in (I)

But in sodium formate resonance is equivalent



(iv) Because in the first step cleavage of ester is done which is difficult to do.

(v) Because in addition reaction, electron donating

tendency of  $\text{>C=O}$  and  $\text{>C=C<}$  are different

$\text{>C=C<}$  is better than  $\text{>C=O}$

**Sol 28:** (A) C<sub>9</sub>H<sub>12</sub>O

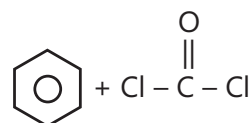
(i) Optically active

(ii) acidic hydrogen -OH

(iii) group

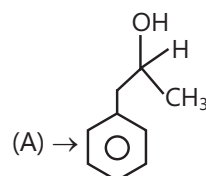
(iv)  $\text{>C=C<}$  do not present

(v) (A)  $\xrightarrow[\text{KMnO}_4]{\text{hot}}$  (B)  $\xleftarrow{\text{H}^+}$  C<sub>7</sub>H<sub>6</sub>O<sub>2</sub>



(vi) (A)  $\xrightarrow[\text{HI}]{\text{P}}$  (e)   
 Optically inactive compound

(vii) 2 alcohol



**Sol 29:**  $\frac{H}{5 \times 10^{-4}} \times 40 = 8$

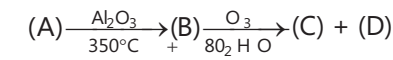
$\Delta T = \text{kg m} \frac{\text{moles}}{\text{mass in kg}}$

$\frac{0.088}{M} = 10^{-6}$

mass = 88

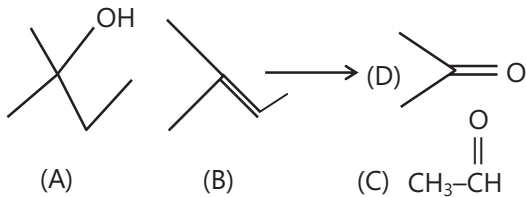
carbon atom =  $\frac{68.18}{12} \approx 12$

oxygen = 1

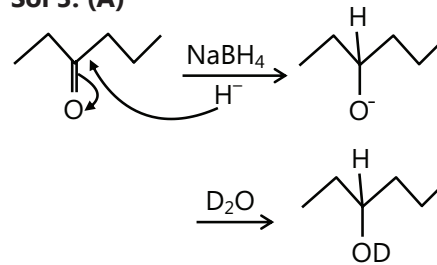


-OH  
Group  
Present  
 $\text{C}_5\text{H}_{12}\text{O}$

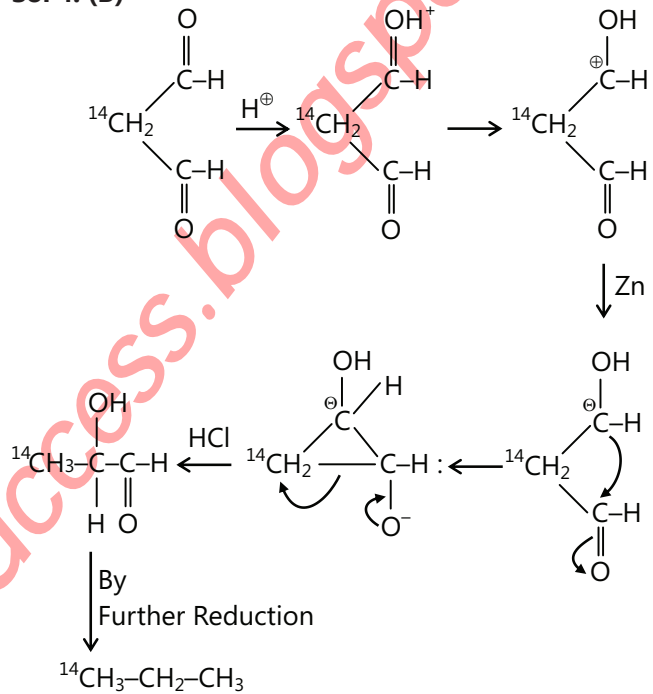
↓  
Fehling  
test



**Sol 3: (A)**



**Sol 4: (B)**



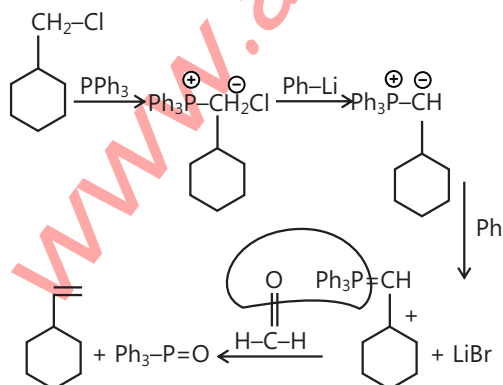
## Exercise 2

### Single Correct Choice Type

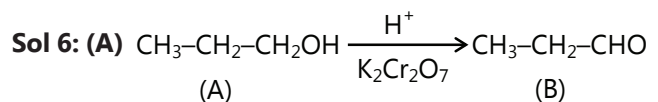
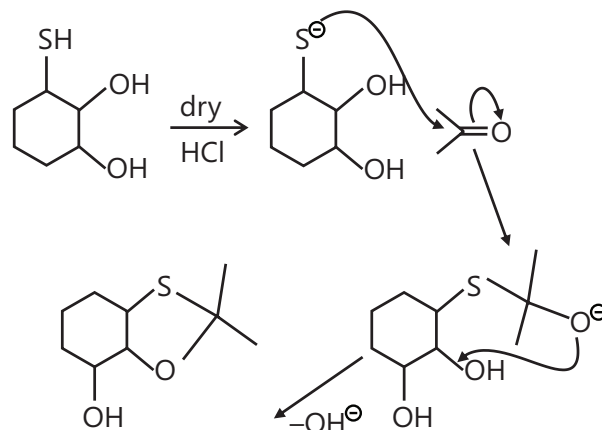


OH + MeCH-COONa  
Cannizzaro reaction

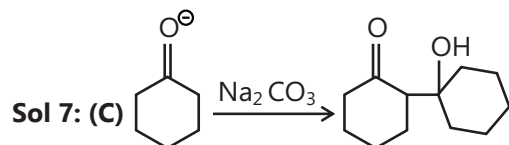
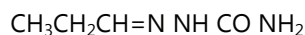
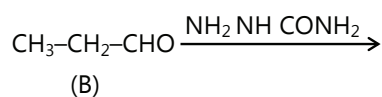
**Sol 2: (C)**



**Sol 5: (B)**

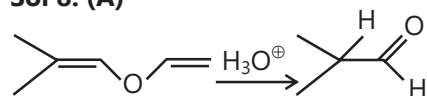


B forms a shining silver mirror on warming

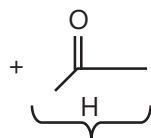


aldol condensation will occur as  $\text{Na}_2\text{CO}_3$  is a base.

**Sol 8: (A)**

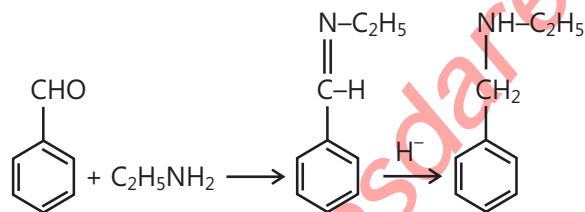


It will not  
Give iodoform  
test

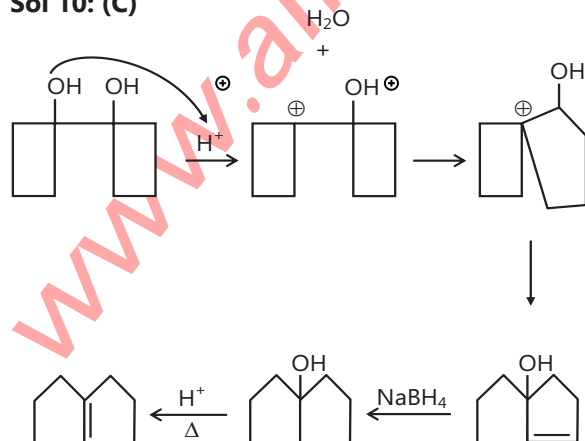


It will give positive  
iodoform test

**Sol 9: (D)**

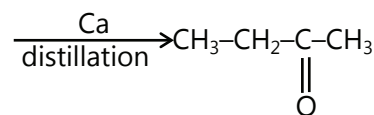


**Sol 10: (C)**



**Sol 11: (B)** Hydration will occur at position 2 as carbon at positive 2 has maximum  $\delta^+$  charge due to  $-I$  effect of other carbonyl groups.

**Sol 12: (C)**  $\text{CH}_3\text{-CH}_2\text{-COOH} + \text{CH}_3\text{-COOH}$

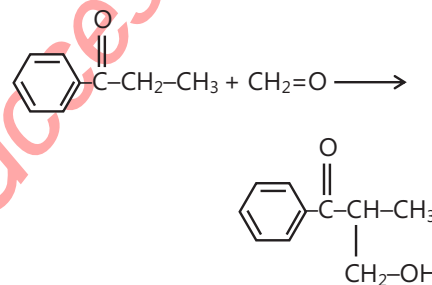


**Sol 13: (C)**  $\text{NaBH}_4$  is weak reducing agent. So it will reduce only the ketone but  $\text{LiAlH}_4$  is strong reducing so it will reduce both ester and ketone.

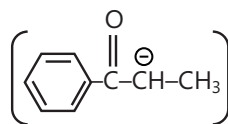
**Sol 14: (C)**  $\text{CH}_3\text{-CH}_2\text{-OH}$  &  $\text{CH}_3\text{-C(=O)-CH}_3$

LAN oxidises alcohol to aldehyde or ketone so only  $\text{CH}_3\text{-CH}_2\text{-OH}$  will give positive test.

**Sol 15: (B)**

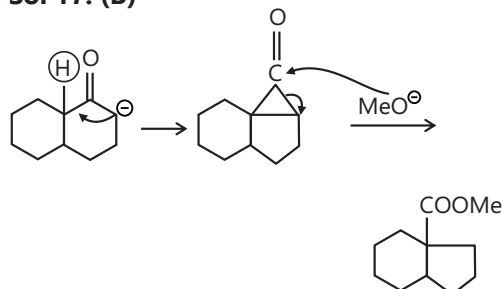


best  
most reactive carbonion  $\left[ \text{>C=O} \right]$   
group



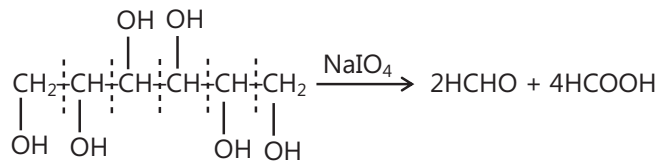
**Sol 16: (B)** Aromatic aldehydes do not give positive test with Fehling's solution.

**Sol 17: (B)**

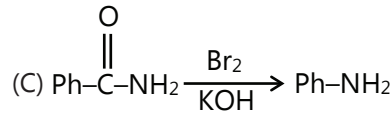
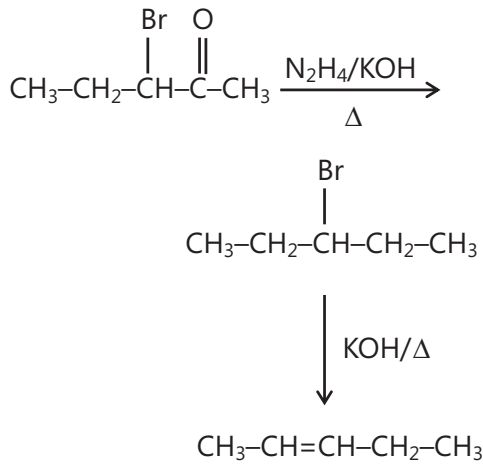




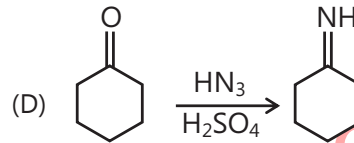
**Sol 18: (D)**



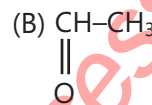
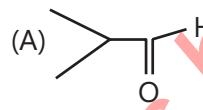
**Sol 19: (D)**



Hoffmann  
Bromamide



**Sol 22: (B, C, D)**

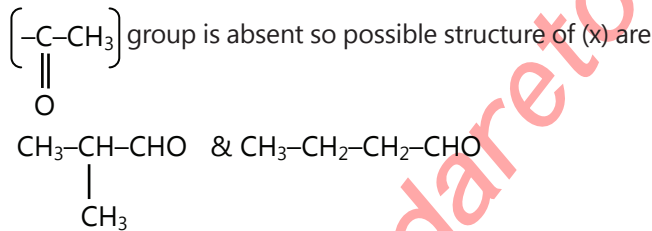


So only Iodoform can distinguish between them.

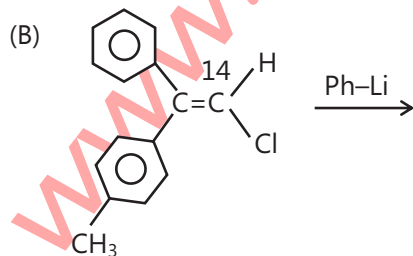
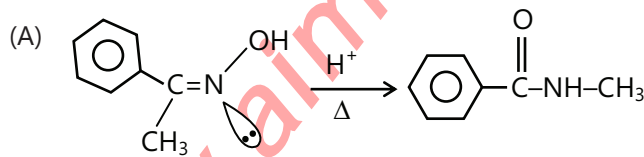
**Multiple Correct Choice Type**

**Sol 20: (B, D)** Aldehydes gives 2, 4-DNP test so (x)

should have aldehyde x gives negative Iodoform  $\Rightarrow$

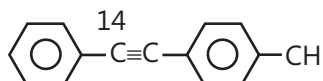
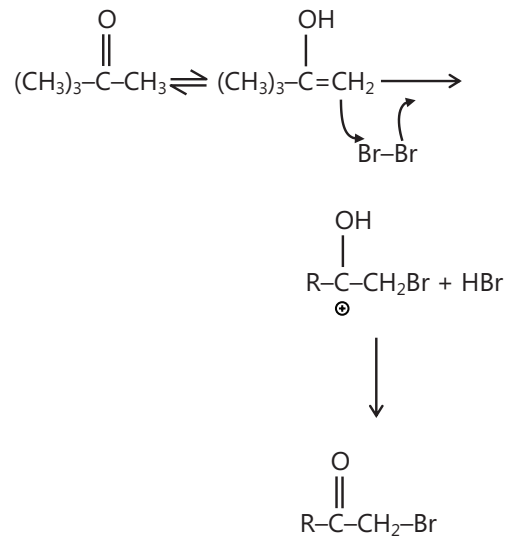
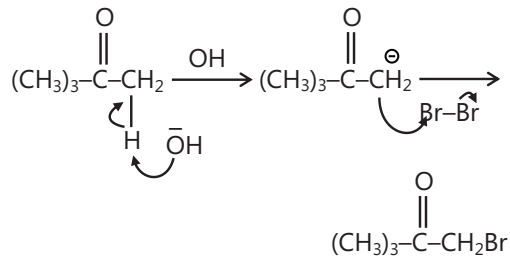


**Sol 21: (A, B, D)**



**Comprehension Type**

**Sol 23: (C)**

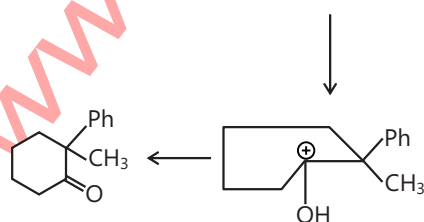
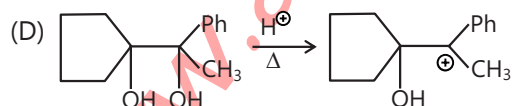
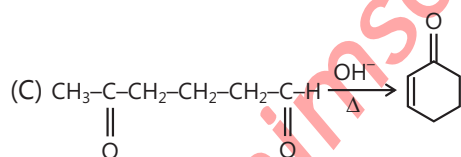
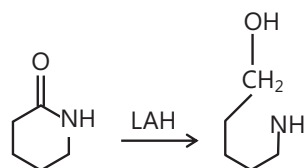
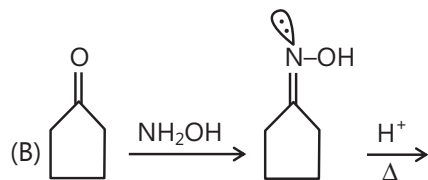
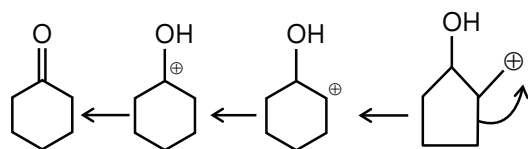
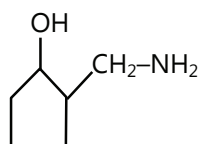
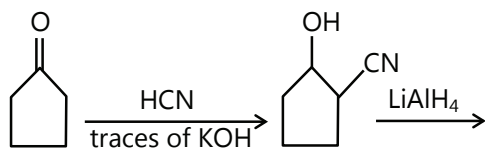


**Sol 24: (B)** Overall yield =  $0.58 \times 0.54 \times 0.68$

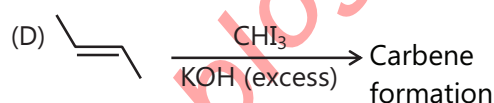
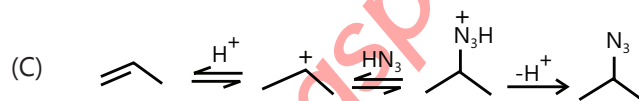
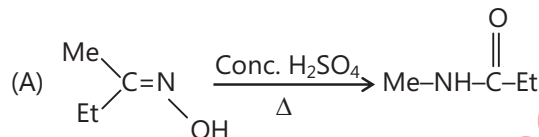
Overall yield =  $0.21 = 21\%$

**Sol 25:** A  $\rightarrow$  p, q, s; B  $\rightarrow$  p; C  $\rightarrow$  p, q, s; D  $\rightarrow$  p, q, s

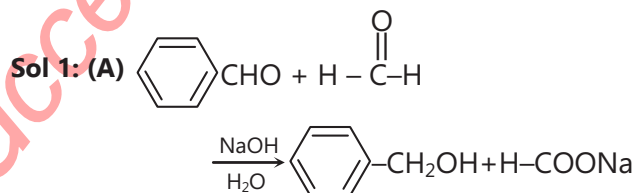
(A)



**Sol 26:** A  $\rightarrow$  r; B  $\rightarrow$  r, s; C  $\rightarrow$  q, s; D  $\rightarrow$  p

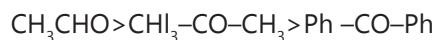


### Previous Years' Questions



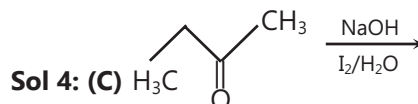
This is an example of cross Cannizzaro reaction in which formaldehyde is always oxidized.

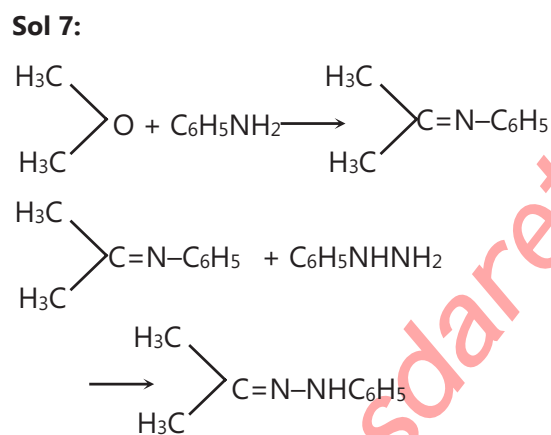
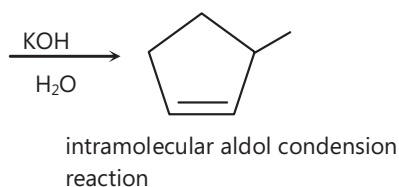
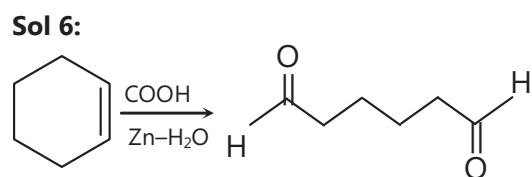
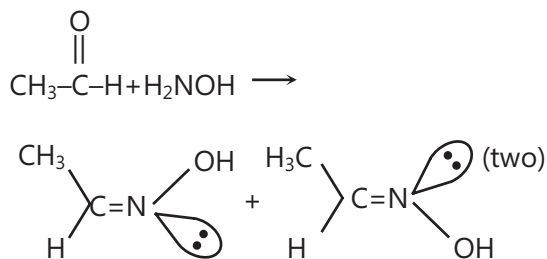
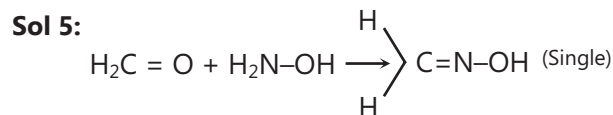
**Sol 2: (C)** The reactivity of carbonyl compound towards nucleophilic addition of Grignard's reagent depends on extent of steric hindrance at  $\alpha$ -carbon. Greater the steric hindrance smaller the reactivity. Hence, reactivity order is



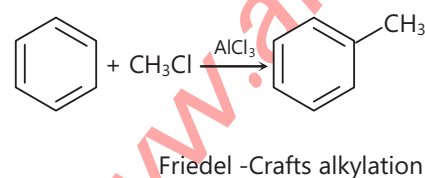
II I III

**Sol 3: (C)** X is  $(\text{CH}_3\text{CO})_2\text{O}$  and it is an example of Perkin's reaction.



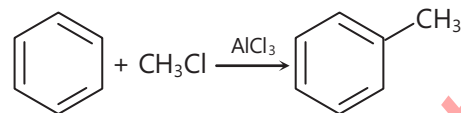


**Sol 8:** In both Friedel-Crafts reaction and Reimer-Tiemann's reaction new carbon-carbon bond is formed.

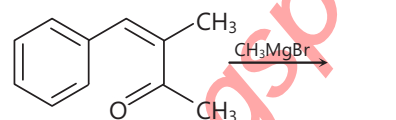


**Comprehension 1 (Questions 9 to 11)**

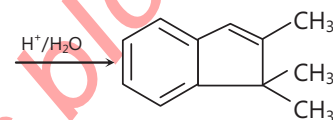
**Sol: Q.9 B, Q.10 A and Q.11 B**



Friedel-Crafts alkylation

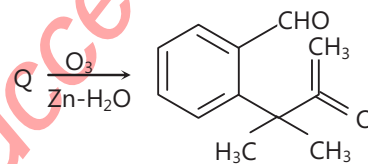


P

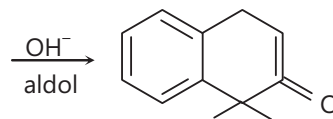


Q

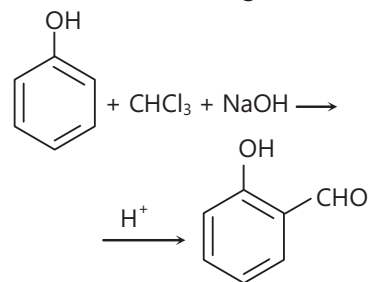
(gives possible iodoform test)



R



S



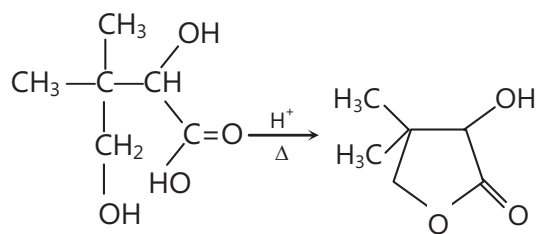
Reimer-Tiemann's reaction

All those carbonyl compounds containing  $\alpha$ -H to  $\text{sp}^2$  carbon show keto-enol tautomerism.

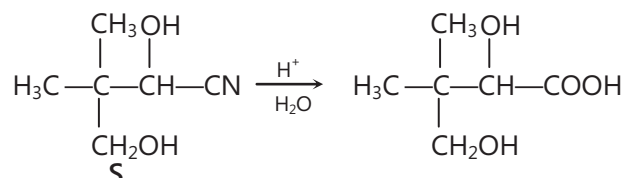
**Comprehension 2 (Questions 12 to 14)**

**Sol: Q.12 B Q.13 A and Q.14 D**

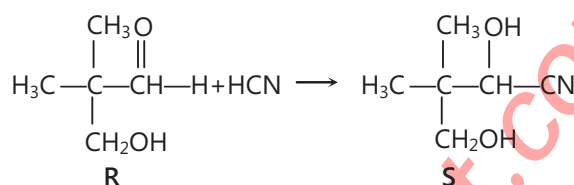
The given product an ester, obtained by condensation of a hydroxy acid obtained through hydrolysis of a cyanohydrin -



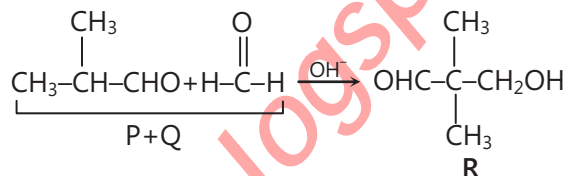
Acid above is obtained by acid hydrolysis of cyanohydrin S as



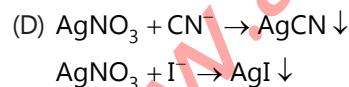
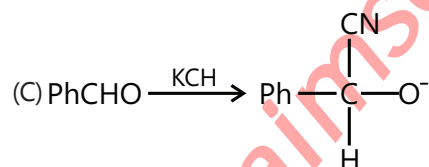
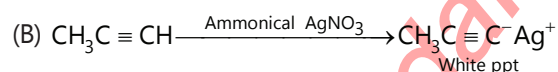
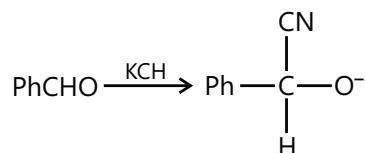
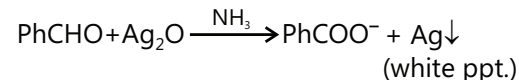
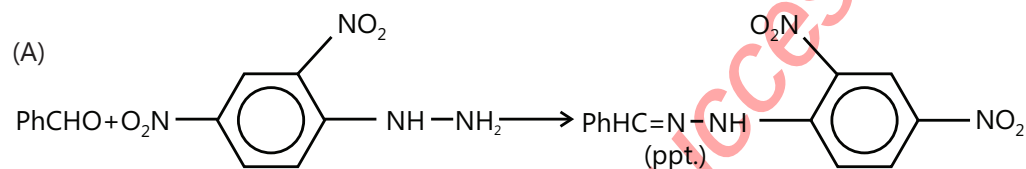
S is obtained by nucleophile addition of HCN on R, hence R is



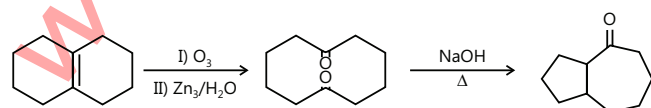
R is obtained by treatment of P and Q aqueous  $\text{K}_2\text{CO}_3$  Through aldol condensation reaction as



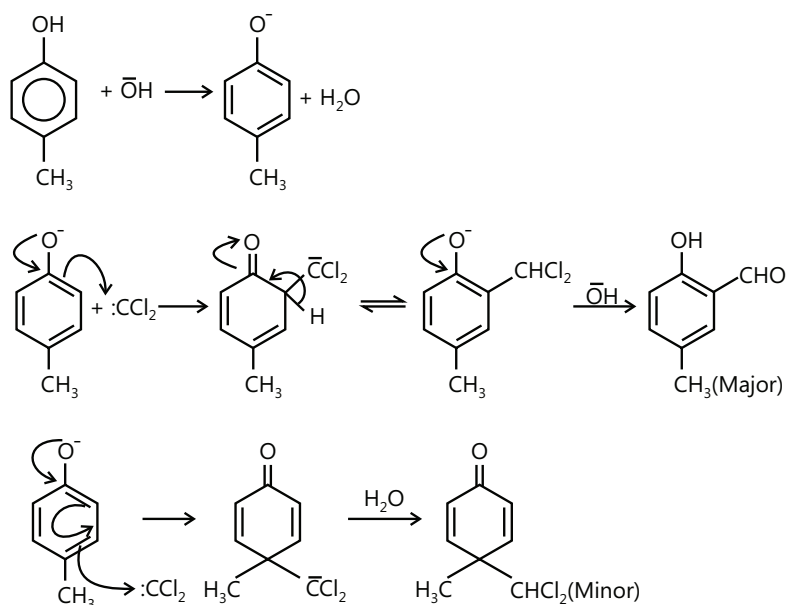
**Sol 15:** A  $\rightarrow$  p, q; B  $\rightarrow$  q, r; C  $\rightarrow$  q, r, s; D  $\rightarrow$  q, r



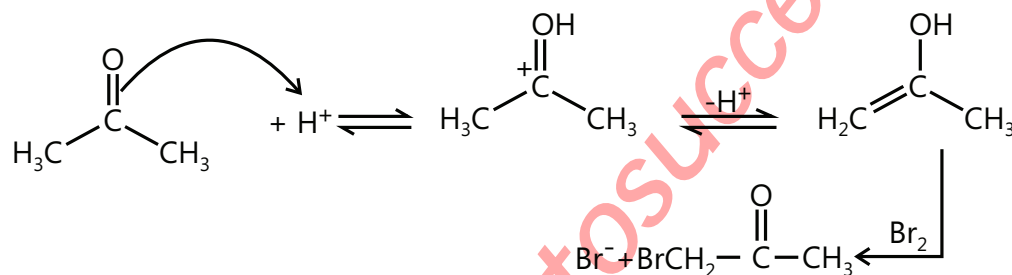
**Sol 16: (1)**





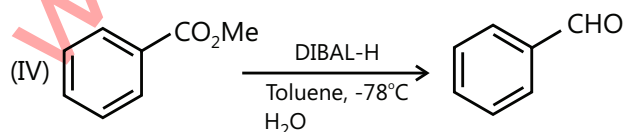
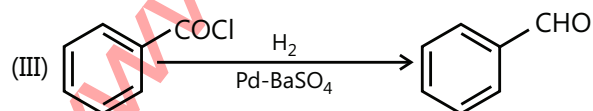
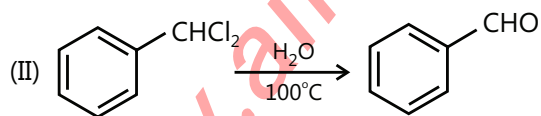
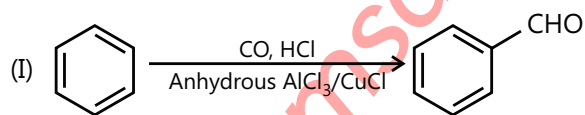


**Sol 22: (C)** Solve as per law of limiting reagent.

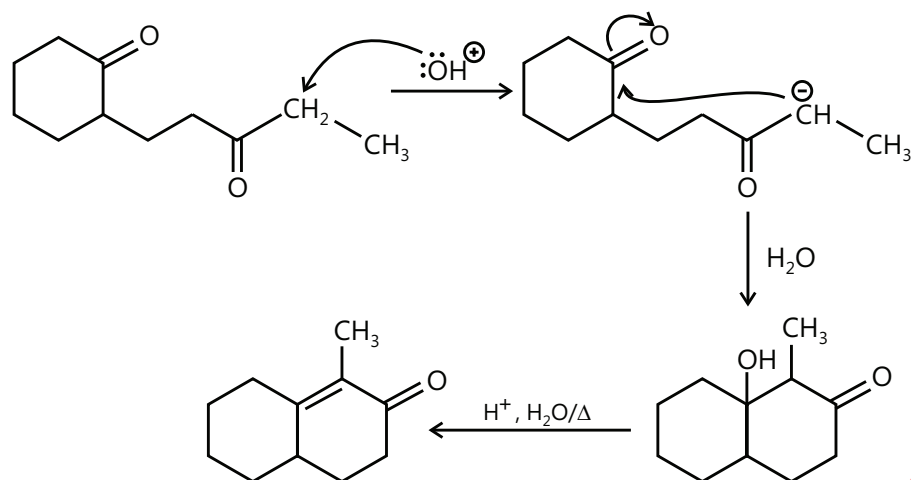


**Sol 23: (D)** PCC (Pyridinium chlorochromate) is a mild oxidising agent. It oxidises alcohol to aldehyde.

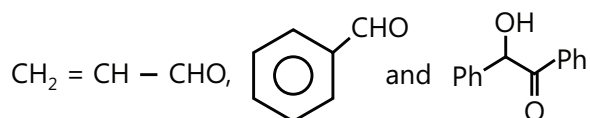
**Sol 24: (A, B, C, D)**



Sol 25: (A)



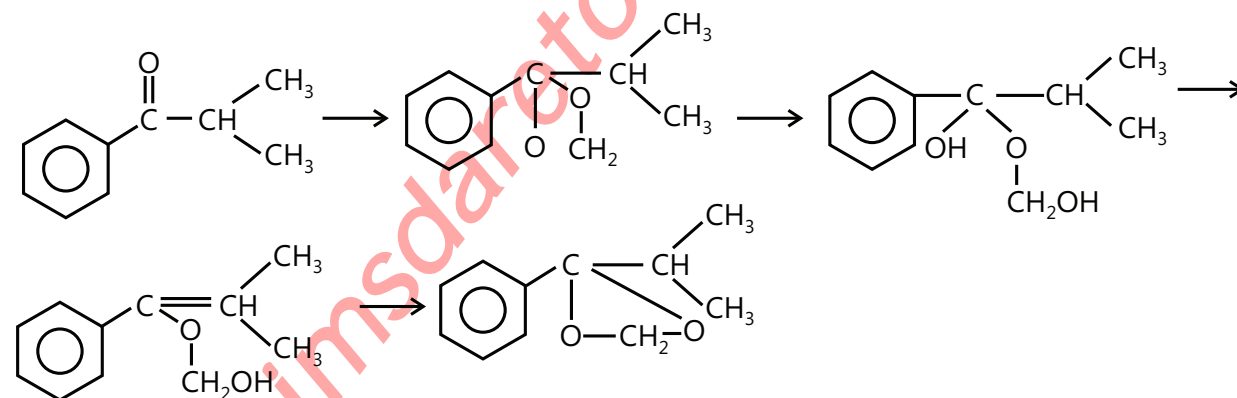
Sol 26: (A, B, C)



Gives positive test with Tollen's reagent.

Sol 27: (C)  $\text{NaBH}_4$  in  $\text{C}_2\text{H}_5\text{OH}$  selectively reduces aldehydic group.

Sol 28 : (A)



## Empower your JEE Main & Advanced preparation with specially designed and structured study packages from PLANCESS

Planceess offers this must-have Study Package in Chemistry comprising seven books to meet the complete curriculum needs of engineering aspirants. The books offer complete and systematic coverage of JEE (Main) and JEE (Advanced) syllabi and aims to provide firm foundation in learning and problem solving skills.

The theory offers engaging explanation of concepts with important points highlighted through Facts, Notes, Tips & Tricks, Misconceptions and Key Take Away. The application of the concepts is explained by means of illustrative examples and the problem-solving skills are further enhanced through solved examples of JEE (Main) and JEE (Advanced) levels. Extensive and classified assessment (JEE Main, JEE Advanced and Boards) along with the questions from previous years papers of the target examinations, offers the aspirants a competitive edge in preparation. This study package thus provides a single solution for all their preparation requirements.

### Salient Features

- Concept description sprinkled with Planceess Concepts and Illustrative Examples
- Problem-Solving Strategy (Tactics)
- Formula Sheet/Points to Remember
- Solved Examples - JEE Main
- Solved Examples - JEE Advanced
- Exercises - JEE Main and Boards
- Previous Years' Questions - JEE Main
- Exercises - JEE Advanced and Boards
- Previous Years Questions - JEE Advanced
- Answer Key and Solutions (Complete)

### Planceess EduSolutions Pvt. Ltd.

A005/A006 Boomerang  
Chandivali Farm Road,  
Chandivali, Andheri (East)  
Mumbai - 400072, India  
Tel: 022 6604 3405  
[www.planceess.com](http://www.planceess.com)



Copyright © 2017